

---

# Logic Selection Guide

Second Half 2003

---

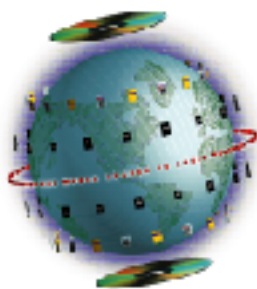

Service & Support

Innovation

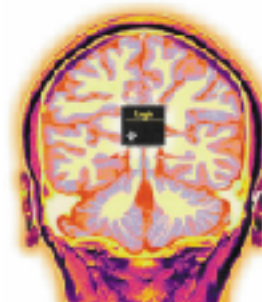

Product Breadth

Permanency



Your **Logical** Choice.

---

**LOGIC OVERVIEW**

**1**

**FOCUS ON NAVIGATING THE TI LOGIC WEB**

**2**

**FUNCTIONAL INDEX**

**3**

**FUNCTIONAL CROSS-REFERENCE**

**4**

**DEVICE SELECTION GUIDE**

**5**

**PACKAGING AND MARKING INFORMATION**

**A**

**LOGIC PURCHASING TOOL/ALTERNATE SOURCES**

**B**

# **LOGIC SELECTION GUIDE**

**SECOND HALF 2003**

## IMPORTANT NOTICE

Texas Instruments Incorporated and its subsidiaries (TI) reserve the right to make corrections, modifications, enhancements, improvements, and other changes to its products and services at any time and to discontinue any product or service without notice. Customers should obtain the latest relevant information before placing orders and should verify that such information is current and complete. All products are sold subject to TI's terms and conditions of sale supplied at the time of order acknowledgment.

TI warrants performance of its hardware products to the specifications applicable at the time of sale in accordance with TI's standard warranty. Testing and other quality control techniques are used to the extent TI deems necessary to support this warranty. Except where mandated by government requirements, testing of all parameters of each product is not necessarily performed.

TI assumes no liability for applications assistance or customer product design. Customers are responsible for their products and applications using TI components. To minimize the risks associated with customer products and applications, customers should provide adequate design and operating safeguards.

TI does not warrant or represent that any license, either express or implied, is granted under any TI patent right, copyright, mask work right, or other TI intellectual property right relating to any combination, machine, or process in which TI products or services are used. Information published by TI regarding third-party products or services does not constitute a license from TI to use such products or services or a warranty or endorsement thereof. Use of such information may require a license from a third party under the patents or other intellectual property of the third party, or a license from TI under the patents or other intellectual property of TI.

Reproduction of information in TI data books or data sheets is permissible only if reproduction is without alteration and is accompanied by all associated warranties, conditions, limitations, and notices. Reproduction of this information with alteration is an unfair and deceptive business practice. TI is not responsible or liable for such altered documentation.

Resale of TI products or services with statements different from or beyond the parameters stated by TI for that product or service voids all express and any implied warranties for the associated TI product or service and is an unfair and deceptive business practice. TI is not responsible or liable for any such statements.

Following are URLs where you can obtain information on other Texas Instruments products & application solutions:

<b>Products</b>		<b>Applications</b>	
Amplifiers	<a href="http://amplifier.ti.com">amplifier.ti.com</a>	Audio	<a href="http://www.ti.com/audio">www.ti.com/audio</a>
Data Converters	<a href="http://dataconverter.ti.com">dataconverter.ti.com</a>	Automotive	<a href="http://www.ti.com/automotive">www.ti.com/automotive</a>
DSP	<a href="http://dsp.ti.com">dsp.ti.com</a>	Broadband	<a href="http://www.ti.com/broadband">www.ti.com/broadband</a>
Interface	<a href="http://interface.ti.com">interface.ti.com</a>	Digital Control	<a href="http://www.ti.com/digitalcontrol">www.ti.com/digitalcontrol</a>
Logic	<a href="http://logic.ti.com">logic.ti.com</a>	Military	<a href="http://www.ti.com/military">www.ti.com/military</a>
Power Mgmt	<a href="http://power.ti.com">power.ti.com</a>	Optical Networking	<a href="http://www.ti.com/opticalnetwork">www.ti.com/opticalnetwork</a>
Microcontrollers	<a href="http://microcontroller.ti.com">microcontroller.ti.com</a>	Security	<a href="http://www.ti.com/security">www.ti.com/security</a>
		Telephony	<a href="http://www.ti.com/telephony">www.ti.com/telephony</a>
		Video & Imaging	<a href="http://www.ti.com/video">www.ti.com/video</a>
		Wireless	<a href="http://www.ti.com/wireless">www.ti.com/wireless</a>

Mailing Address: Texas Instruments  
Post Office Box 655303 Dallas, Texas 75265



### CONTACTS/INFORMATION

---

#### TI HOME PAGE

<http://www.ti.com>

#### TI LOGIC HOME PAGE

<http://www.ti.com/sc/logic>

#### TI MILITARY SEMICONDUCTOR HOME PAGE

<http://www.ti.com/sc/docs/military>

---

### PRODUCT INFORMATION CENTER

[http://www.ti.com/  
cgi-bin/sc/support.cgi](http://www.ti.com/cgi-bin/sc/support.cgi)

#### DATA SHEETS

<http://www.ti.com/sc/logic>

Texas Instruments offers a full spectrum of logic functions and technologies from the mature to the advanced, including bipolar, BiCMOS, and CMOS. TI's process technologies offer the logic performance and features required for modern logic designs, while maintaining support for more traditional logic products. TI's offerings include products in the following process technologies or device families:

- AC, ACT, AHC, AHCT, ALVC, AUC, AVC, FCT, HC, HCT, LV, LVC, TVC
- ABT, ABTE, ALB, ALVT, BCT, HSTL, LVT, SSTL, SSTU, SSTV, SSTVF
- BTA, CB3Q, CB3T, CBT, CBTLV, FB, FIFO, GTL, GTLP, JTAG, PCA, PCF, VME
- ALS, AS, F, LS, S, TTL

TI offers specialized, advanced logic products that improve overall system performance and address design issues, including testability, low skew requirements, bus termination, memory drivers, and low-impedance drivers.

TI offers a wide variety of packaging options, including advanced surface-mount packaging in fine-pitch small-outline ball-grid-array (BGA) packages, quad flat no-lead (QFN) packages for gates and octals, and WCSP (NanoStar™/NanoFree™) packages for single-, dual-, and triple-gate functions. The NanoStar™/NanoFree™ packages are the newest logic options. These WCSP packages are the world's smallest logic packages offering a 70% savings in space over industry standard SC-70 packages.

For further information on TI logic families, refer to the list of current TI logic technical documentation provided in this preface. For an overview of TI logic, see Section 1. Section 2 contains a *Focus on Navigating the TI Logic Web*. Sections 3, 4, and 5 contain a functional index, functional cross-reference, and device selection guide, respectively. These sections list the functions offered, package availability, and applicable literature numbers of data sheets. Appendix A includes additional information about packaging and symbolization. Appendix B provides a cross-reference to match other manufacturers' products to those of TI. Data sheets can be downloaded from the internet at <http://www.ti.com> or ordered through your local sales office or TI authorized distributor. Please see the back cover of this selection guide for additional information.

## CURRENT TI LOGIC TECHNICAL DOCUMENTATION

Listed below is the current collection of TI logic technical documentation. These documents can be ordered through a TI representative or authorized distributor by referencing the appropriate literature number.

Document	Literature Number
ABT Logic Advanced BiCMOS Technology Data Book (1997) .....	SCBD002C
AC/ACT CMOS Logic Data Book (1997) .....	SCAD001D
AHC/AHCT Logic Advanced High-Speed CMOS Data Book (April 2000) .....	SCLD003B
AHC/AHCT Designer's Guide (February 2000) .....	SCLA013D
ALS/AS Logic Data Book (1995) .....	SDAD001C
ALVC Advanced Low-Voltage CMOS Data Book .....	SCED006B
AUC Advanced Ultra-Low-Voltage CMOS Data Book (January 2003) .....	SCED011A
AVC Advanced Very-Low-Voltage CMOS Data Book (March 2000) .....	SCED008C
BCT BiCMOS Bus-Interface Logic Data Book (1994) .....	SCBD001B
Boundary-Scan Logic IEEE Std 1149.1 (JTAG) Data Book (1997) .....	SCTD002A
IEEE Std 1149.1 (JTAG) Testability Primer (1997) .....	SSYA002C
CBT (5-V) and CBTLV (3.3-V) Bus Switches Data Book (December 1998) .....	SCDD001B
Design Considerations for Logic Products Application Book (1997) .....	SDYA002
Design Considerations for Logic Products Application Book, Volume 2 (September 1999) .....	SDYA018
Design Considerations for Logic Products Application Book, Volume 3 (December 2000) .....	SDYA019
F Logic Data Book (1994) .....	SDFD001B
GTL/GTLP Logic High-Performance Backplane Drivers (September 2001) .....	SCED004A
HC/HCT Logic High-Speed CMOS Data Book (2003) .....	SCLD001E
Little Logic Data Book (November 2001) .....	SCED010
LVC and LV Low-Voltage CMOS Logic Data Book (1998) .....	SCBD152B
LVT Logic Low-Voltage Technology Data Book (1998) .....	SCBD154
Mobile Computing Logic Solutions Data Book (July 1999) .....	SCPD002
Semiconductor Group Package Outlines Reference Guide (1999) .....	SSYU001E
Signal Switch Including Digital/Analog/Bilateral Switches and Voltage Clamps Data Book (December 2001) .....	SCDD003

**See [www.ti.com/sc/logic](http://www.ti.com/sc/logic) for the most current data sheets.**

## TABLE OF CONTENTS

<b>SECTION 1 - LOGIC OVERVIEW .....</b>	<b>1-1</b>
Welcome to the World of TI Logic .....	1-5
Product Life Cycle .....	1-6
Family Performance Positioning .....	1-7
Low-Voltage Market .....	1-8
TI Logic Supports Voltage Migration .....	1-9
Device Names and Package Designators .....	1-10
Logic Vendor Partnerships .....	1-11
IC Basics .....	1-12
Logic Feature List .....	1-13
Bus-Hold Input .....	1-14
Series Damping Resistors .....	1-15
Partial Power Down .....	1-16
Hot Insertion .....	1-17
Live Insertion .....	1-18
Mixed-Voltage Interfacing .....	1-19
Special “Dual-Supply” Level Shifters .....	1-20
What Is Little Logic? .....	1-21
Little Logic TI Portfolio .....	1-22
NanoStar™/NanoFree™ Package .....	1-23
AUC .....	1-24
AVC .....	1-25
ALVC Family .....	1-26
LVC Family .....	1-27
LV-A Family .....	1-28
LVT Family .....	1-29
ALVT Family .....	1-30
Bus Switch – Functional Description .....	1-31
Bus Switch – Key Characteristics .....	1-32
Bus Switch – Architecture .....	1-33
Bus Switch – New Families .....	1-35
TVC .....	1-36
What Is GTL/GTLP? .....	1-37
GTLP Is a Bidirectional Translator .....	1-38
GTLP and VME Are Specifically Designed for High-Performance Multislot Parallel Backplanes .....	1-39
GTLP .....	1-40
SN74VMEH22501 UBT .....	1-41
Logic Roadmap for High-Speed Memory Interface .....	1-42
DDR Register Solutions .....	1-43
Packaging Options .....	1-44
TI FIFO Products .....	1-45
TI FIFO Product and Technology Roadmap .....	1-46
TI FIFOs Optimize System Performance .....	1-47
IEEE 1149.1 (JTAG) Boundary-Scan Logic .....	1-48
Current TI JTAG Product Offering .....	1-49
Typical System-Level Application .....	1-50
Typical JTAG Applications .....	1-52

---

**SECTION 2 - FOCUS ON NAVIGATING THE TI LOGIC WEB ..... 2-1**

Web User Reference to Searching logic.ti.com ..... 2-5  
Web User Reference to Navigating logic.ti.com ..... 2-6

**SECTION 3 - FUNCTIONAL INDEX ..... 3-1**

Backplane Logic (GTL, GTLP, FB+/BTL, and ABTE/ETL) ..... 3-5  
    Drivers and Transceivers ..... 3-5

Boundary-Scan IEEE Std 1149.1 (JTAG) Logic ..... 3-6  
    Boundary-Scan (JTAG) Bus Devices ..... 3-6  
    Boundary-Scan (JTAG) Support Devices ..... 3-7

Buffers and Drivers ..... 3-7  
    Inverting Buffers and Drivers ..... 3-7  
    Noninverting Buffers and Drivers ..... 3-9

Bus Switches ..... 3-12  
    Bus Exchange/Multiplexing Switches ..... 3-12  
    Standard Bus Switches ..... 3-12

Counters ..... 3-14  
    Binary Counters ..... 3-14  
    Decade Counters ..... 3-15

Decoders, Encoders, and Multiplexers ..... 3-16  
    Decoders ..... 3-16  
    Multiplexers ..... 3-17  
    Priority Encoders ..... 3-18

FIFOs (First-In, First-Out Memories) ..... 3-19  
    Asynchronous FIFO Memories ..... 3-19  
    Synchronous FIFO Memories ..... 3-20

Flip-Flops ..... 3-21  
    D-Type Flip-Flops (3-state) ..... 3-21  
    D-Type Flip-Flops (non 3-state) ..... 3-23  
    Other Flip-Flops ..... 3-23

Gates and Inverters ..... 3-24  
    AND Gates ..... 3-24  
    NAND Gates ..... 3-24  
    AND-OR-Invert Gates ..... 3-26  
    OR Gates ..... 3-26  
    NOR Gates ..... 3-27  
    Exclusive-OR Gates ..... 3-27  
    Exclusive-NOR Gates ..... 3-28  
    Gate and Delay Elements ..... 3-28  
    Inverters ..... 3-29

## TABLE OF CONTENTS (continued)

### SECTION 3 (continued)

Latches .....	3-30
D-Type Latches (3-state) .....	3-30
Other Latches .....	3-31
Little Logic .....	3-31
AND Gates .....	3-31
NAND Gates .....	3-32
OR Gates .....	3-32
NOR Gates .....	3-32
Exclusive-OR Gates .....	3-32
D-Type Flip-Flops .....	3-33
Decoders .....	3-33
Inverters .....	3-33
Inverting Buffers and Drivers .....	3-34
Noninverting Buffers and Drivers .....	3-34
Multiplexers .....	3-34
Specialty Logic .....	3-35
Standard Bus Switches .....	3-35
Memory Drivers and Transceivers (HSTL, SSTL, SSTU, and SSTV/SSTVF) .....	3-35
Buffers, Drivers, and Latches .....	3-35
Registers .....	3-36
Registers .....	3-36
Specialty Logic .....	3-37
Adders .....	3-37
Arithmetic Logic Units .....	3-37
Bus-Termination Arrays and Networks .....	3-37
Comparators (identity) .....	3-38
Comparators (magnitude) .....	3-38
Digital Phase-Locked Loops (PLLs) .....	3-38
Drivers/Multipliers .....	3-38
ECL/TTL Functions .....	3-39
Frequency Dividers/Timers .....	3-39
I <sup>2</sup> C Functions .....	3-39
Little Logic .....	3-39
Monostable Multivibrators .....	3-40
Oscillators .....	3-40
Parity Generators and Checkers .....	3-40
Translation Voltage Clamps .....	3-41
Voltage-Level Shifters .....	3-41
Transceivers .....	3-41
Parity Transceivers .....	3-41
Registered Transceivers .....	3-42
Standard Transceivers .....	3-43

---

**SECTION 3 (continued)**

Universal Bus Functions ..... 3-47  
    Universal Bus Transceivers ..... 3-47  
    Universal Bus Drivers ..... 3-48  
    Universal Bus Exchangers ..... 3-48

**SECTION 4 - FUNCTIONAL CROSS-REFERENCE ..... 4-1**

**SECTION 5 - DEVICE SELECTION GUIDE ..... 5-1**

ABT – Advanced BiCMOS Technology Logic ..... 5-5  
ABTE/ETL – Advanced BiCMOS Technology/Enhanced Transceiver Logic ..... 5-13  
AC/ACT – Advanced CMOS Logic ..... 5-15  
AHC/AHCT – Advanced High-Speed CMOS Logic ..... 5-23  
ALB – Advanced Low-Voltage BiCMOS Logic ..... 5-29  
ALS – Advanced Low-Power Schottky Logic ..... 5-31  
ALVC – Advanced Low-Voltage CMOS Technology Logic ..... 5-37  
ALVT – Advanced Low-Voltage BiCMOS Technology Logic ..... 5-43  
AS – Advanced Schottky Logic ..... 5-45  
AUC – Advanced Ultra-Low-Voltage CMOS Logic ..... 5-49  
AVC – Advanced Very-Low-Voltage CMOS Logic ..... 5-53  
BCT – BiCMOS Technology Logic ..... 5-55  
64BCT – 64-Series BiCMOS Technology Logic ..... 5-55  
BTA – Bus-Termination Arrays ..... 5-59  
CB3Q – Low-Voltage High-Bandwidth Bus-Switch Crossbar Technology Logic ..... 5-61  
CB3T – Low-Voltage Translator Bus-Switch Crossbar Technology Logic ..... 5-63  
CBT – Crossbar Technology Logic ..... 5-65  
CBTLV – Low-Voltage Crossbar Technology Logic ..... 5-69  
CD4000 – CMOS B-Series Integrated Circuits ..... 5-71  
74F – Fast Logic ..... 5-75  
FB+/BTL – FutureBus+/Backplane Transceiver Logic ..... 5-79  
FCT – Fast CMOS TTL Logic ..... 5-81  
FIFO – First-In, First-Out Memories ..... 5-87  
GTL – Gunning Transceiver Logic ..... 5-91  
GTLF – Gunning Transceiver Logic Plus ..... 5-93  
HC/HCT – High-Speed CMOS Logic ..... 5-99  
IEEE Std 1149.1 (JTAG) Boundary-Scan Logic ..... 5-109  
Little Logic ..... 5-113  
LS – Low-Power Schottky Logic ..... 5-119  
LV – Low-Voltage CMOS Technology Logic ..... 5-125  
LVC – Low-Voltage CMOS Technology Logic ..... 5-129  
LVT – Low-Voltage BiCMOS Technology Logic ..... 5-137  
PCA/PCF – I<sup>2</sup>C Inter-Integrated Circuit Applications ..... 5-143

## TABLE OF CONTENTS (continued)

---

### SECTION 5 (continued)

S – Schottky Logic .....	5–145
SSTL – Stub Series-Terminated Logic .....	5–149
HSTL – High-Speed Transceiver Logic .....	5–149
SSTU – Stub Series-Terminated Ultra-Low-Voltage Logic .....	5–151
SSTV/SSTVF – Stub Series-Terminated Low-Voltage Logic .....	5–155
TTL – Transistor-Transistor Logic .....	5–159
TVC – Translation Voltage Clamp Logic .....	5–161
VME – VERSAmodule Eurocard Bus Technology .....	5–163

### APPENDIX A - PACKAGING AND MARKING INFORMATION ..... A-1

Device Names and Package Designators for TI Logic Products .....	A–5
Device Names and Package Designators for Logic Products Formerly Offered by Cypress Semiconductor .....	A–6
Device Names and Package Designators for Logic Products Formerly Offered by Harris Semiconductor ..	A–7
Logic Marking Guidelines .....	A–9
Moisture Sensitivity by Package .....	A–16
Packaging Cross-Reference .....	A–18

### APPENDIX B - LOGIC PURCHASING TOOL/ALTERNATE SOURCES ..... B-1

<b>LOGIC OVERVIEW</b>	<b>1</b>
<b>FOCUS ON NAVIGATING THE TI LOGIC WEB</b>	<b>2</b>
<b>FUNCTIONAL INDEX</b>	<b>3</b>
<b>FUNCTIONAL CROSS-REFERENCE</b>	<b>4</b>
<b>DEVICE SELECTION GUIDE</b>	<b>5</b>
<b>PACKAGING AND MARKING INFORMATION</b>	<b>A</b>
<b>LOGIC PURCHASING TOOL/ALTERNATE SOURCES</b>	<b>B</b>





## **LOGIC OVERVIEW**

## SECTION 1 LOGIC OVERVIEW

---

### CONTENTS

Welcome to the World of TI Logic .....	1-5
Product Life Cycle .....	1-6
Family Performance Positioning .....	1-7
Low-Voltage Market .....	1-8
TI Logic Supports Voltage Migration .....	1-9
Device Names and Package Designators .....	1-10
Logic Vendor Partnerships .....	1-11
IC Basics .....	1-12
Logic Feature List .....	1-13
Bus-Hold Input .....	1-14
Series Damping Resistors .....	1-15
Partial Power Down .....	1-16
Hot Insertion .....	1-17
Live Insertion .....	1-18
Mixed-Voltage Interfacing .....	1-19
Special “Dual-Supply” Level Shifters .....	1-20
What Is Little Logic? .....	1-21
Little Logic TI Portfolio .....	1-22
NanoStar™/NanoFree™ Package .....	1-23
AUC .....	1-24
AVC .....	1-25
ALVC Family .....	1-26
LVC Family .....	1-27
LV-A Family .....	1-28
LVT Family .....	1-29
ALVT Family .....	1-30
Bus Switch – Functional Description .....	1-31
Bus Switch – Key Characteristics .....	1-32
Bus Switch – Architecture .....	1-33
Bus Switch – New Families .....	1-35
TVC .....	1-36
What Is GTL/GTLP? .....	1-37
GTLP Is a Bidirectional Translator .....	1-38
GTLP and VME Are Specifically Designed for High-Performance Multislot Parallel Backplanes .....	1-39
GTLP .....	1-40
SN74VMEH22501 UBT .....	1-41
Logic Roadmap for High-Speed Memory Interface .....	1-42
DDR Register Solutions .....	1-43
Packaging Options .....	1-44
TI FIFO Products .....	1-45
TI FIFO Product and Technology Roadmap .....	1-46
TI FIFOs Optimize System Performance .....	1-47
IEEE 1149.1 (JTAG) Boundary-Scan Logic .....	1-48

---

**CONTENTS (continued)**

Current TI JTAG Product Offering .....	1-49
Typical System-Level Application .....	1-50
Typical JTAG Applications .....	1-52

# Welcome to the World of TI Logic

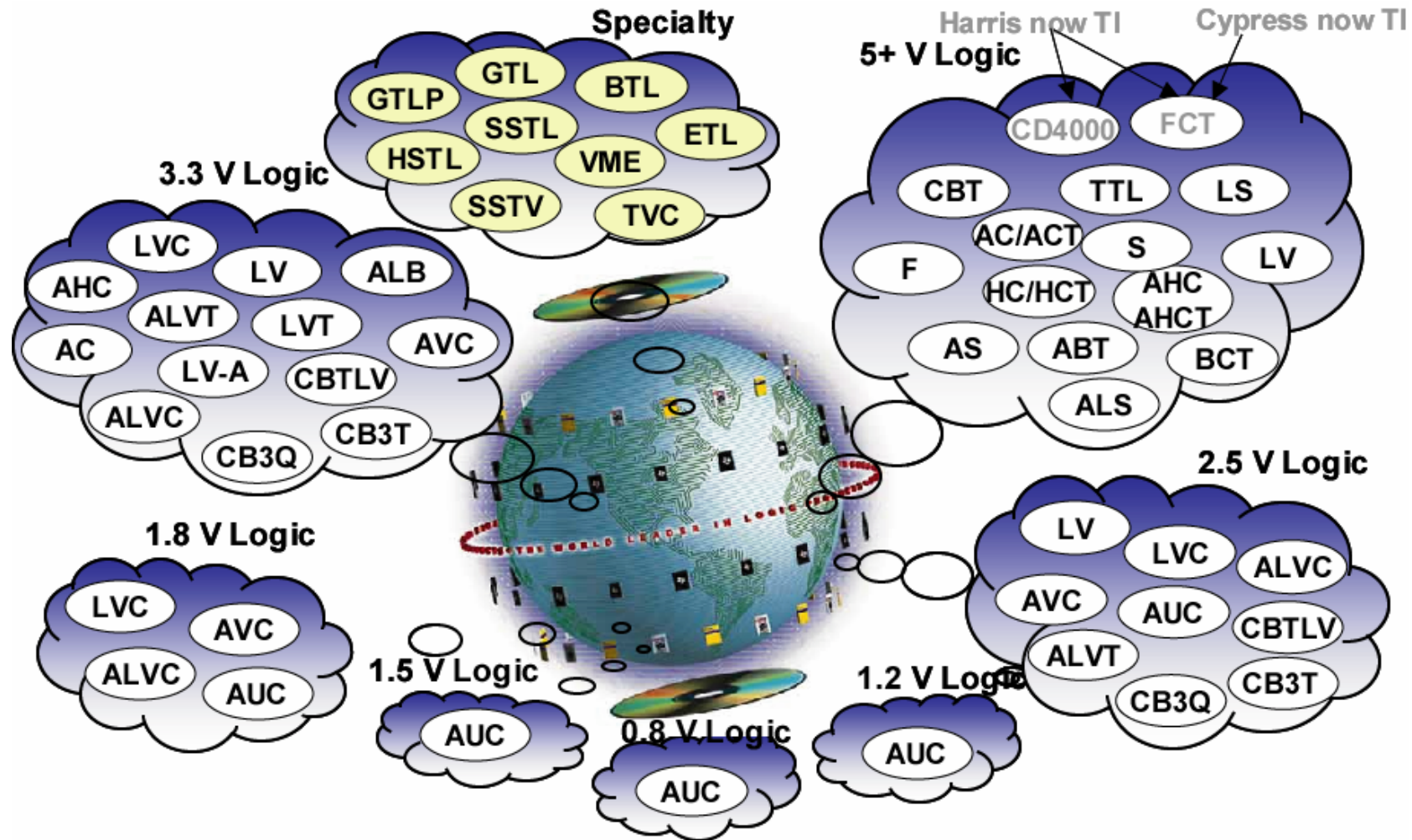
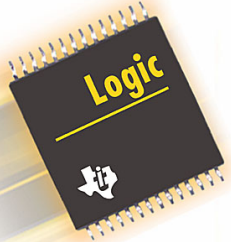

# Product Life Cycle

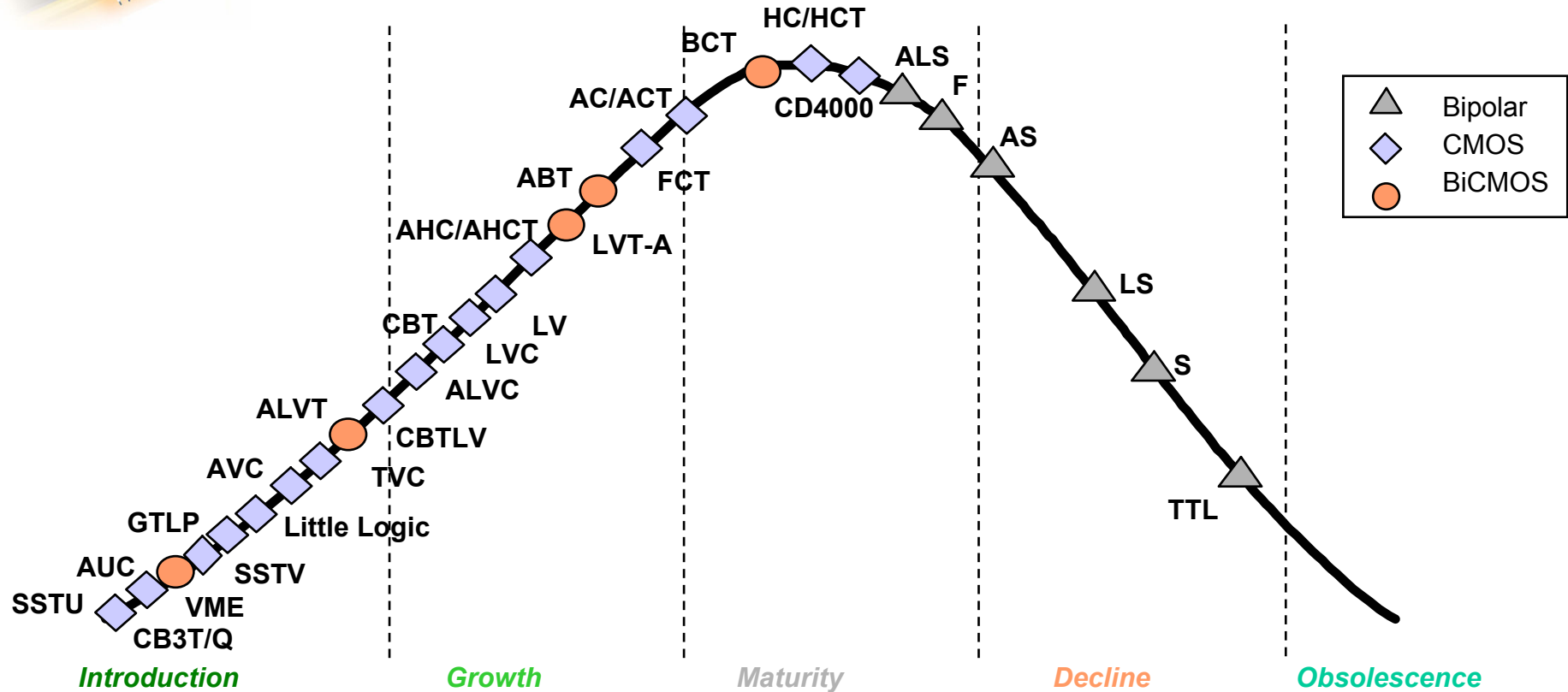

TI remains committed to be the last supplier in the older families.

Investment levels for new products are at an all-time high.

# Family Performance Positioning

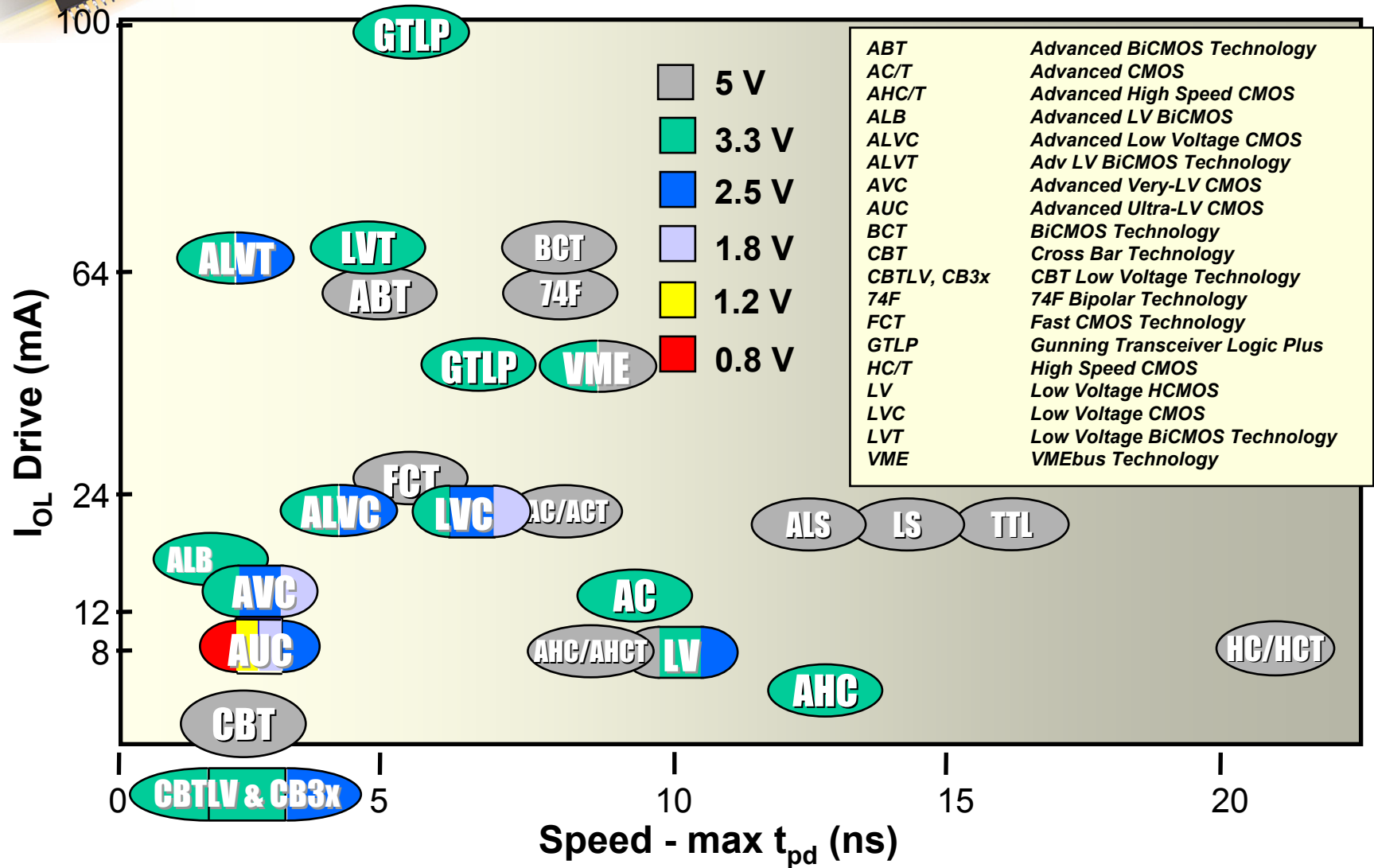

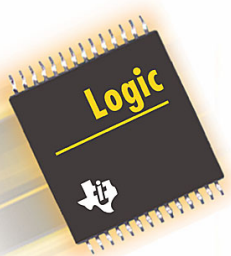

# Low-Voltage Market

## Coverage and Standardization

5 V	HCT, LS	AHC/T, LV	AC/T, ACH/T ALS, 74F	ABT			
3.3 V		AHC, LV	LVC	LVT	ALVC	ALVT	
2.5 V		LV	LVC		ALVC	ALVT	AUC
1.8 V			LVC		ALVC		AUC
1.2 V							AUC
0.8 V							AUC

**Speed Performance**

**AHC/T**

- ✓ 8.5-ns  $t_{pd}$  (5 V)
- ✓ 13.5-ns  $t_{pd}$  (3.3 V)
- ✓ -8/8 mA (5 V)
- ✓ -4/4 mA (3.3 V)
- ✓ 5-V or 3.3-V  $V_{CC}$
- ✓ 5-V input tolerant
- ✓ 2 WW sources

**LV**

- ✓ 6.5-ns  $t_{pd}$  (5 V)
- ✓ 10-ns  $t_{pd}$  (3.3 V)
- ✓ -16/16 mA (5 V)
- ✓ -8/8 mA (3.3 V)
- ✓ 5-V input tolerant
- ✓ 3 WW sources
- ✓ Partial Power Down †

**LVC**

- ✓ 6.5-ns  $t_{pd}$
- ✓ -24/24 mA
- ✓ Ultra-low (20  $\mu$ A) standby power
- ✓ 4 WW sources
- ✓ Bus hold option
- ✓ 5-V tolerant
- ✓ Gate functions
- ✓ Partial Power Down †

**LVT**

- ✓ 4-ns  $t_{pd}$
- ✓ -32/64 mA
- ✓ Low (90  $\mu$ A) standby power
- ✓ 4 WW sources
- ✓ Bus hold option
- ✓ 5-V tolerant
- ✓ Hot insertion ‡

**ALVC**

- ✓ 3-ns  $t_{pd}$
- ✓ -24/24 mA
- ✓ Very-low (40  $\mu$ A) standby power
- ✓ 5 WW sources
- ✓ Bus hold

**ALVT**

- ✓ 2.4-ns  $t_{pd}$
- ✓ -32/64 mA
- ✓ Low (90  $\mu$ A) standby power
- ✓ 3 WW sources
- ✓ Bus hold
- ✓ 5-V tolerant
- ✓ Hot insertion ‡

**AUC**

- ✓ 2-ns speed
- ✓ -8/8-mA drive
- ✓ Ultra-low (10  $\mu$ A) standby power
- ✓ 3 WW sources
- ✓ Bus hold option
- ✓ 3.6-V tolerant

† Partial Power Down supported by  $I_{off}$  feature

‡ Hot Insertion supported by  $I_{off}$  and Power Up 3-State features



# TI Logic Supports Voltage Migration

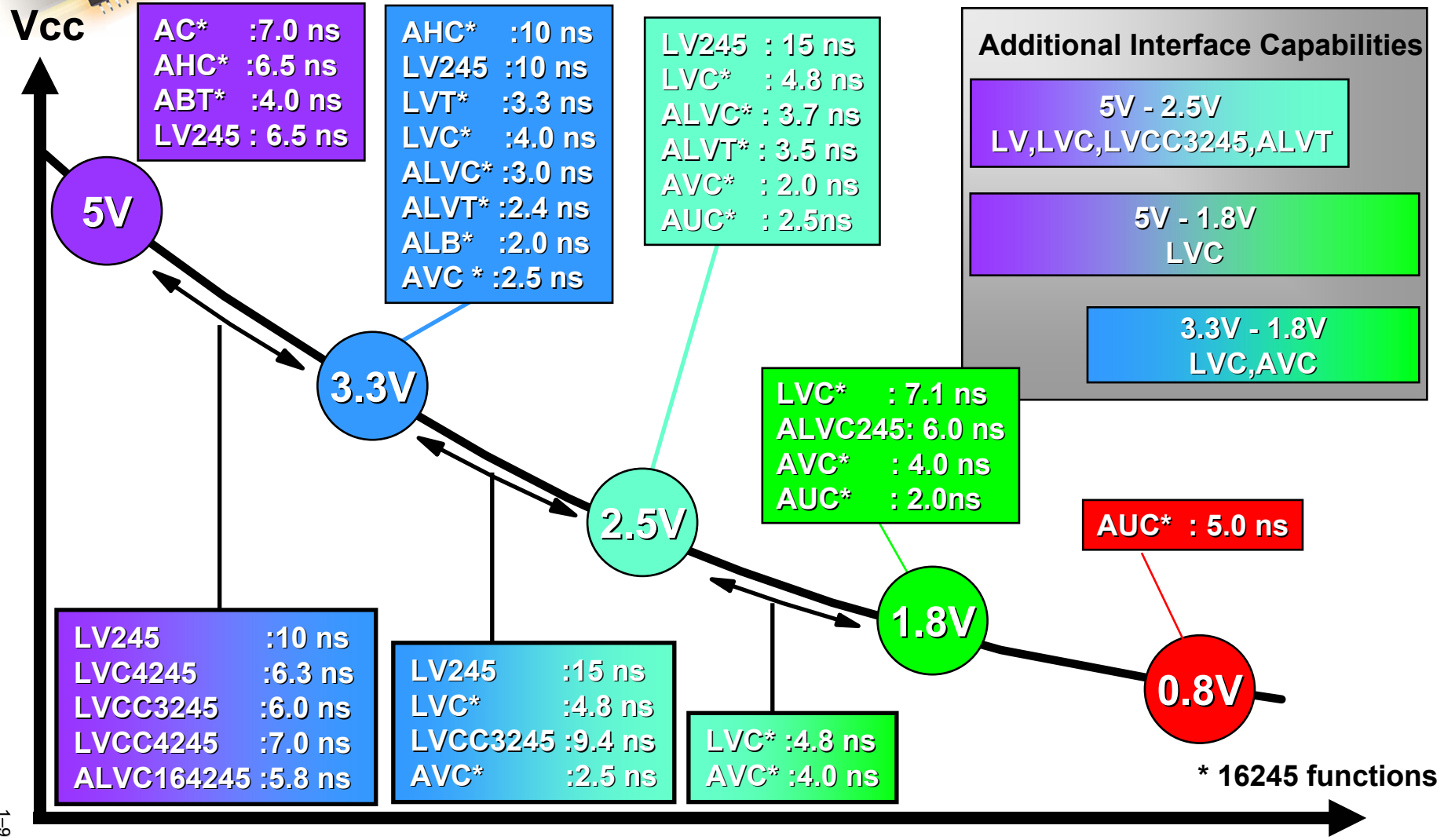

1-9



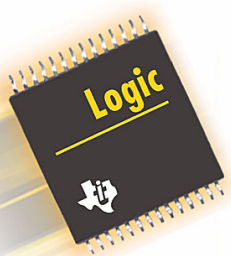

# Device Names and Package Designators

Family  
 ABT/E  
 AC/ACT  
 AHC/AHCT  
 ALB  
 ALS  
 ALVC  
 ALVT  
 AS  
 AUC  
 AVC  
 BCT  
 CBT/LV/CB3x  
 CD4000  
 F  
 FB  
 FCT  
 GTL  
 GTLP  
 HC/HCT  
 HSTL  
 LS  
 LV-A  
 LVC  
 LVT  
 S  
 SSTL  
 SSTU  
 SSTV  
 SSTVF  
 TTL  
 TVC  
 VME

Standard Prefix  
 Military (54)  
 Commercial (74)

Special Feature  
 Blank = no special features  
 A, B, C = Configurable  $V_{CC}$   
 D = Level Shifting Diode  
 H = Bus Hold  
 K = Undershoot Clamp  
 R = Damping Resistor on  
 Inputs/Outputs  
 S = Schottky Clamping Diodes  
 Z = Power Up 3 State

Bit Width  
 Blank = Gates, MSI, and Octals  
 1G = Single Gate  
 2G = Dual Gate  
 3G = Triple Gate  
 8 = Octal IEEE 1149 (JTAG)  
 16 = Widebus™ (16,18, and 20)  
 18 = Widebus IEEE 1149.1 (JTAG)  
 32 = Widebus+™ (32 and 36 bit)

Options  
 Blank = No Options  
 2 = Series Damping  
 Resistor on Outputs  
 3 = Level Shifter  
 4 = Level Shifter  
 25 = 25Ω Line Driver

Function  
 00  
 174  
 244

Device Revision  
 Blank = No Revision  
 Letter Designator A-Z

**SN74** **ABT** **H** **16** **2** **244** **A** **DGG** **R**

Tape & Reel  
 R = 3000  
 T = 250

Package Type  
 D,DW = SOIC  
 DB,DL = SSOP  
 DBB,DGV = TVSOP  
 DCT,DCU = TSSOP  
 DBV, DCK = SOT  
 DGG,PW = TSSOP  
 FK = LCCC  
 FN = PLCC  
 GB = CPGA  
 GKE,GKF = LFBGA  
 GQL = VFBGA  
 HFP,HS,HT,HV = CQFP  
 J,JT = CDIP  
 N,NP,NT = PDIP  
 PAG,PAH,PCA,PCB,PM,  
 PN, PZ = TQFP  
 PH,PQ,RC = QFP  
 RGY,RGQ = QFN  
 W,WA,WD = CFP  
 YEA,YEP,YZA,YZP = DSBGA†

† DSBGA is the JEDEC reference for wafer chip scale package (WCSP).

# Logic Vendor Partnerships



Performance Range	TI	Philips	(Renesas) Hitachi	IDT	Toshiba	FSC	On	
5 V	high	ABT	ABT	ABT	ABT	ABT-C		
	low	AHC	AHC		VHC	VHC	VHC	
3 V	high	CBT-LV		CBT-LV				
		ALVT	ALVT					
		ALVC	ALVC	ALVC	ALVC	VCX	VCX	VCX
	medium	LVT	LVT	LVT			LVT	
		LVC	LVC	LVC	LVC	LCX	LCX	LCX
	low	LV-A	LV	LV-A		LVQ	LVQ	LVQ
						LVX	LVX	
2.5 V	high	AVC	AVC					
1.8 V	high	AUC	AUC				AUC	

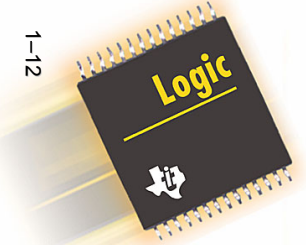

# IC Basics

## Comparison of Switching Standards

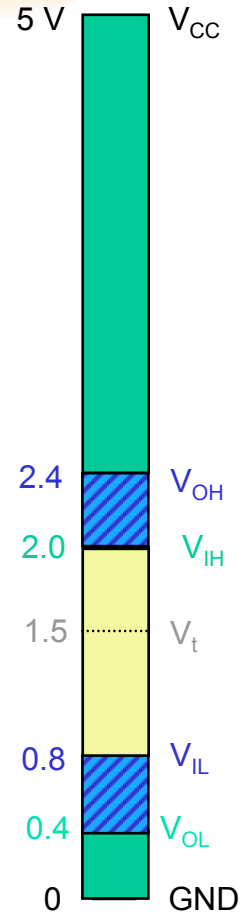

**5-V TTL**  
Standard TTL: ABT, AHCT, HCT, ACT, Bipolar

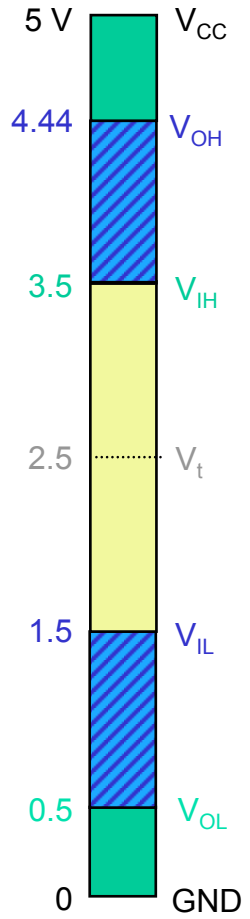

**5-V CMOS**  
Rail-to-Rail 5 V HC, AHC, AC, LV-A

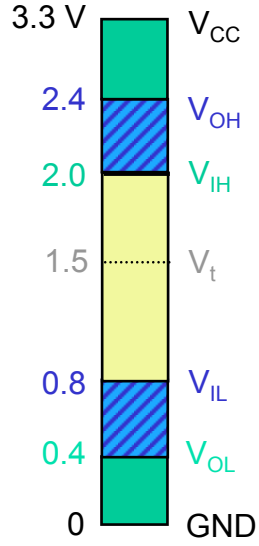
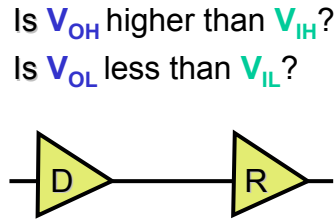

**3.3-V LVTTTL**  
LVT, LVC, ALVC, LV-A, ALVT

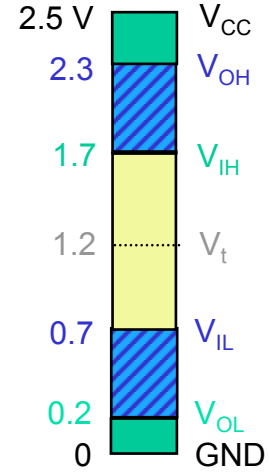

**2.5-V CMOS**  
AUC, AVC, ALVC, LVC, ALVT

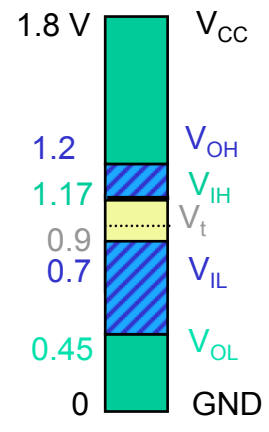

**1.8-V CMOS**  
AUC, AVC, ALVC, LVC

D \ R	5TTL	5CMOS	3LVTTTL	2.5CMOS	1.8CMOS
5TTL	Yes	No	Yes *	Yes*	Yes*
5 CMOS	Yes	Yes	Yes*	Yes*	Yes*
3 LVTTTL	Yes	No	Yes	Yes*	Yes*
2.5 CMOS	Yes	No	Yes	Yes	Yes*
1.8 CMOS	No	No	No	No	Yes

\* Requires  $V_{IH}$  Tolerance

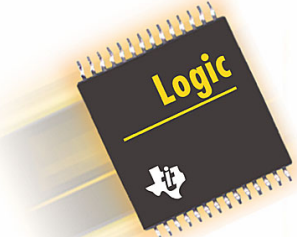

# Logic Feature List †

- ◆ **Bus Hold – ABT, ALVC, ALVT, AVC, AUC, FCT, GTL, GTLP, LVC, LVT, VME**
  - Bus-hold circuitry in selected logic families helps solve the problem of floating inputs and eliminates the need for pull-up or pull-down resistors by holding the last known state of the input. See  $I_{I(HOLD)}$  or  $I_{BHL}$ ,  $I_{BHH}$ ,  $I_{BHLO}$ , and  $I_{BHHO}$  on data sheet.
- ◆ **Series Damping Resistors – ABT, ALVC, ALVT, F, GTLP, LVC, LVT, VME**
  - Series damping resistors limit signal overshoot and undershoot by providing better impedance matching and line termination without the need for external resistors.
- ◆ **Partial Power Down (Level 1 Isolation - I<sub>off</sub>) – ABT, ALVT, AVC, AUC, CBTLV, CBT-C, GTL, GTLP LV-A, LVC, LVT, VME**
  - $I_{OFF}$  circuitry prevents the device from being damaged during hot insertion. See  $I_{OFF}$  specifications on data sheet.
- ◆ **Hot Insertion (Level 2 Isolation – I<sub>off</sub> and Power-up 3-state) – ABT, ALVT, GTLP, LVCZ, LVT, VME**
  - Power-up 3-state ensures valid output levels during power up and valid Z on the outputs during power down. See  $I_{OZPU}$ ,  $I_{OZPD}$ .
- ◆ **Live Insertion (Level 3 Isolation – I<sub>off</sub>, Power-up 3-state, and BIAS  $V_{CC}$ ) – GTLP, FB, CBT, CBTLV, VME**
  - Precharges I/O capacitance, preventing glitching of active data.
- ◆ **Mixed-Voltage-Tolerant I/Os and Level Shifting – AVC, ALVC, ALVT, AUC, GTL, GTLP, LV-A, LVC, LVT**
  - Systems use mixed supply voltages and TTL or CMOS levels in many designs. Most advanced-logic families allow mixed-signal interfacing and provide level-shifting functions for certain mixed-voltage applications.
- ◆ **JTAG – ABT, ACT, BCT, LVT**

1-13

(†selected functions)

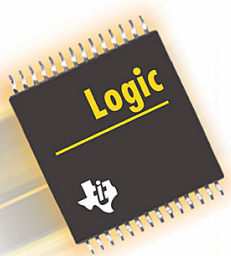

# Bus-Hold Input

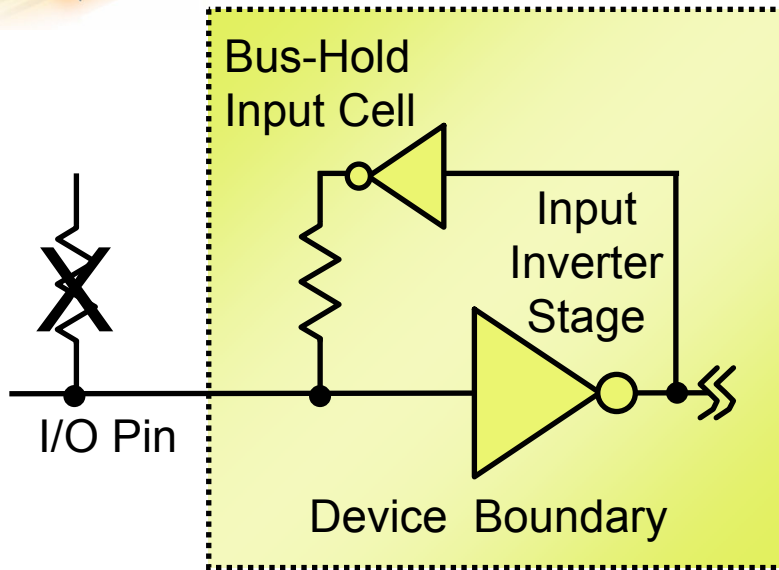

***Bus-hold input cell  
replaces pullup resistor***

- Holds the last known state of the input – avoids floating inputs
- $I_{i(\text{HOLD})}$  or  $I_{\text{BHL}}$ , and  $I_{\text{BHH}}$  specifies min holding current
- Bus-hold current does NOT load down the driving output significantly at valid logic levels.
- Eliminates the need for external resistors on unused or floating input/output pins
- The “H” in the device name indicates bus hold.
- Negligible increase in systems power consumption.

***Families Providing Bus-Hold Options***

**ABT, ALVC, ALVT, AVC, AUC, FCT, GTL, GTLP, LVC, LVT, VME**

# Series Damping Resistors

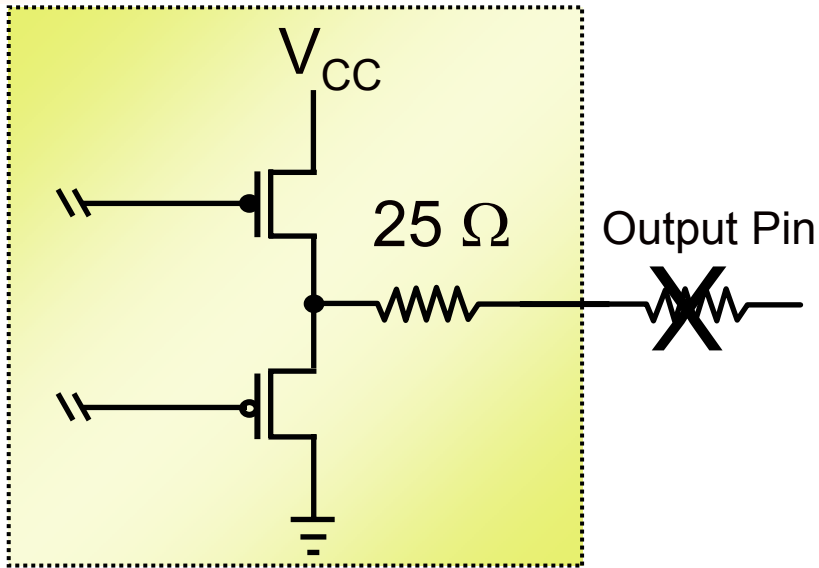
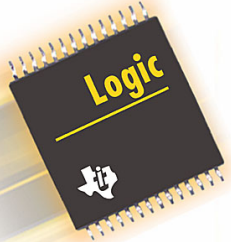

***Damping resistors  
replace external series resistors***

- Improves signal integrity
- Provides better impedance matching and line termination
- Eliminates the need for external series resistors
- Extra “2” or “R” in device name indicates damping resistor option
  - R: I/O pins (LVCHR16245)
  - 2: Output pins (LVC162244)

***Families Providing Damping Resistor Options***

**ABT, ALVC, ALVT, F, GTLP, LVC, LVT, VME**

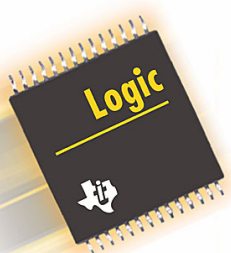

# Partial Power Down

## Live Insertion, Level 1

### System Function Capability

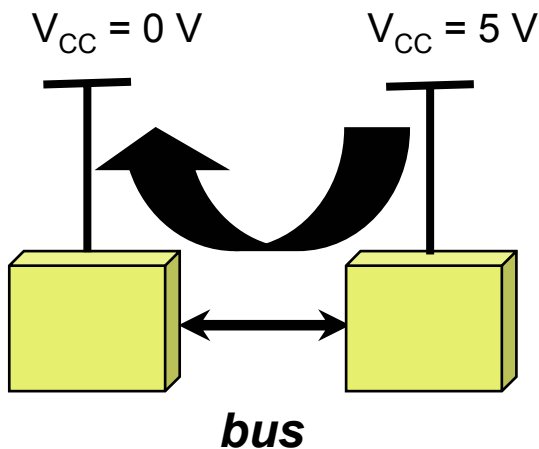

- Prevents unexpected device behavior during power up or power down
- Prevents signals from sourcing current through parasitic diodes
- Allows for power down of partial circuits within a system
- $I_{off}$  spec is required for partial power down operations

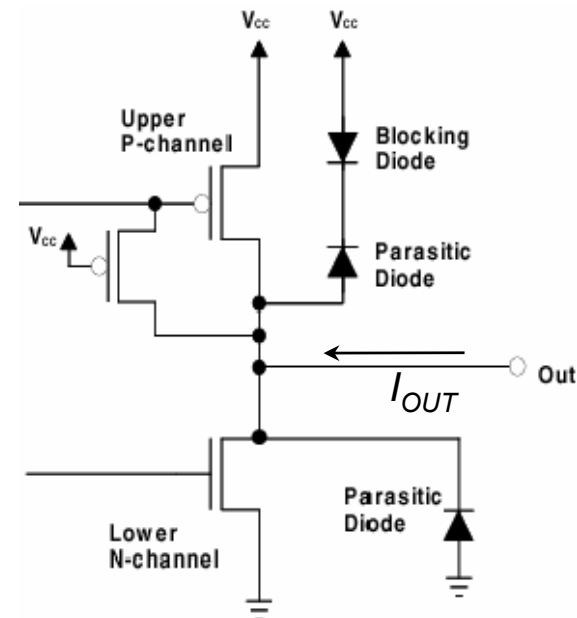

When  $V_{CC} = 0$ ,  $I_{OUT} = 0$  for  $V_{OUT} > V_{CC}$ .

### Families Supporting Partial Power Down ( $I_{off}$ )

ABT, ALVT, AVC, AUC, CBTLV, CBT-C, GTL, GTLP LV-A, LVC, LVT, VME

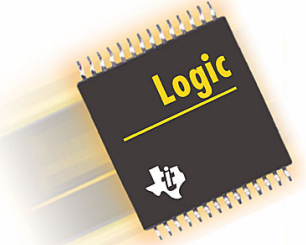

# Hot Insertion

## Live Insertion, Level 2

### System Function/Capability

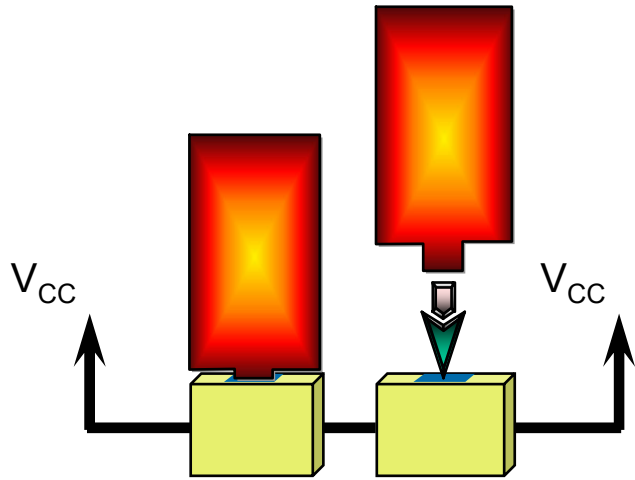

- Prevents unwanted turn-on of output before  $V_{CC}$  trip point
- Prevents bus to be loaded down upon power up of device
- Allows for hot insertion
- $I_{off}$  and PU3S specs are required for Hot Insertion

### Example Circuit Implementation PU3S Circuit

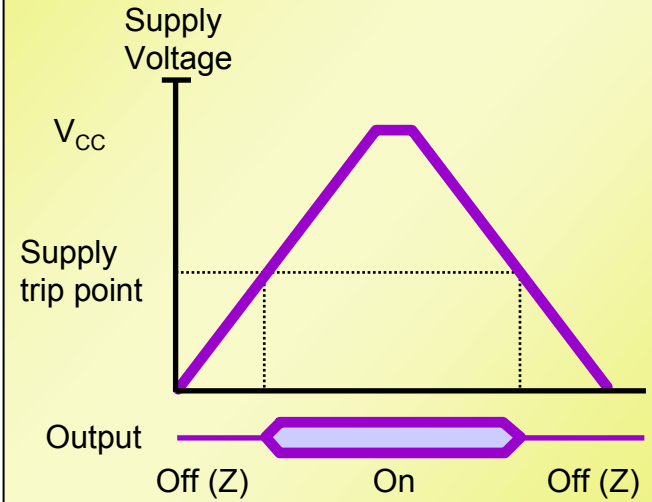

*Families Supporting Hot Insertion ( $I_{off}$  and Power-up 3-state)*

**ABT, ALVT, GTLP, LVCZ, LVT, VME**



# Live Insertion

## Live Insertion, Level 3

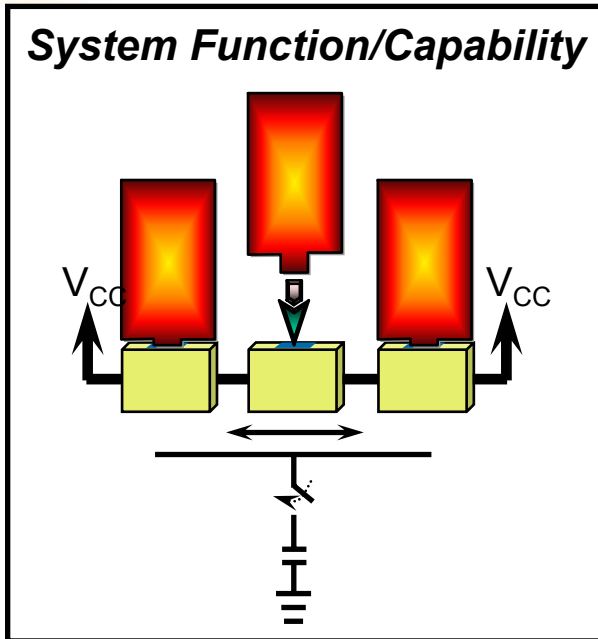

- Prevents unwanted glitches at the I/O
- Allows for live insertion
- $I_{off}$ , PU3S, and BIAS  $V_{CC}$  required for Live Insertion
- Staggered pins required pre-charge functionality

**Families Supporting Live Insertion**  
( $I_{off}$ , Power-up 3-state, and BIAS  $V_{CC}$ )

**GTLV, FB, CBT, CBTLV, VME**

### Circuit Implementation Pre-Charge Circuit

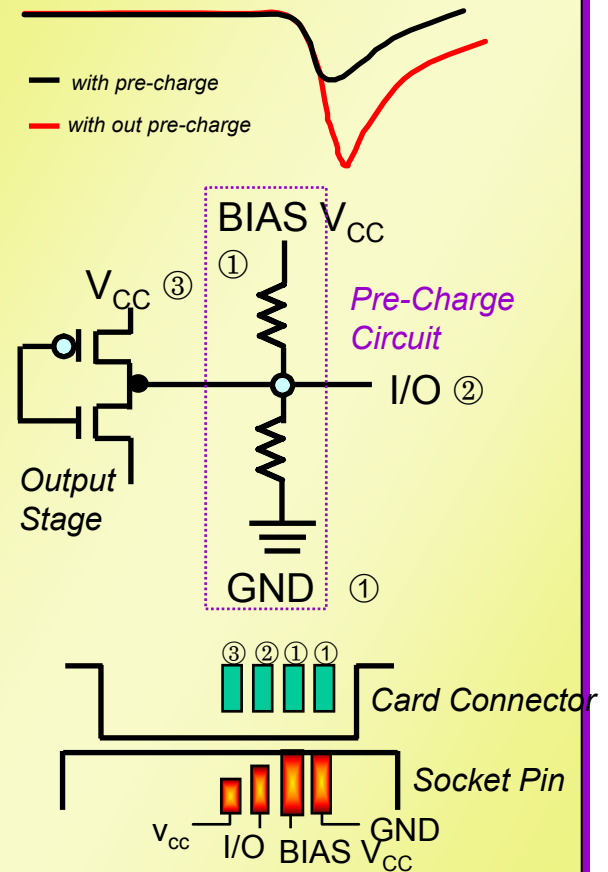

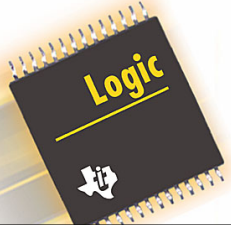

# Mixed-Voltage Interfacing

## Open-Drain Outputs 05/06/07 Functions

### Functions Available

- 05 - S, LS, ALS, AC, HC, AHC, LV, LVC
- 06 - TTL, LS, LV, LVC, LVC1G/3G, AUC1G
- 07 - TTL, LS, LV, LVC, LVC1G/3G, AUC1G

NOTE: Over voltage tolerance is required to support UP translation.

Required **Input** level depends on  $V_{CC1}$

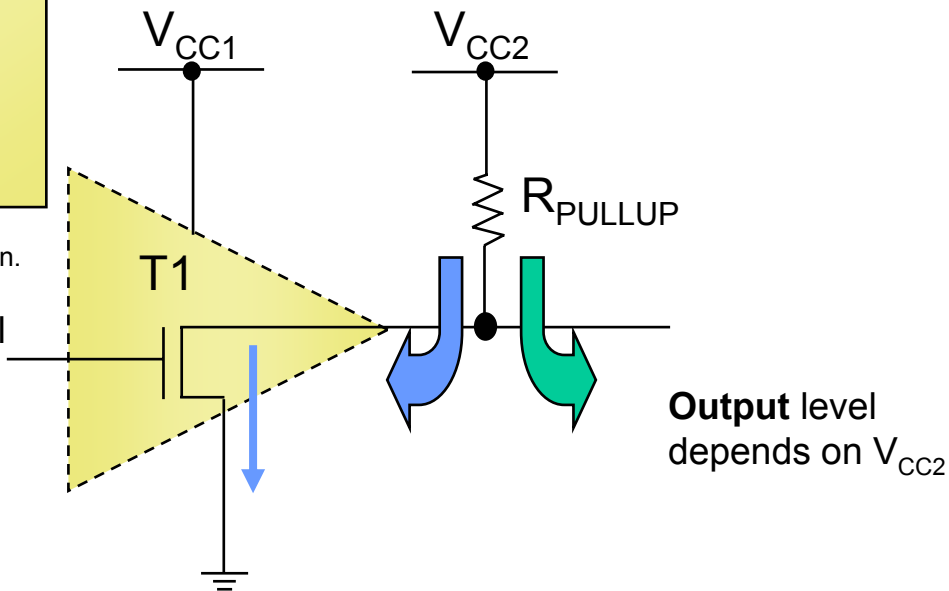

### Also Possible

Wired-Function Technique

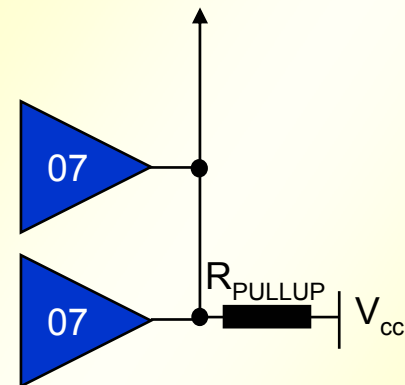

Phantom links on output side can reduce component count.

Supply Voltage $V_{CC1}$	LV05A/06A/07A		LVC06A/07A		LVC1G07/2G07/3G07		Pullup resistor may be connected to	Level conversion range
	$V_i$ Level	Speed	$V_i$ Level	Speed	$V_i$ Level	Speed		
1.8 V	NA	NA	1.8 V Levels	1-3.5 ns	1.8 V Levels	2.4 - 8.3 ns	1.8V, 2.5V, 3.3V and 5V	1.8 V $\leftrightarrow$ 1.8V - 5.5V
2.5 V	2.5 V Levels	6.6 - 10.4 ns	2.5 V Levels	1 - 2.8 ns	2.5 V Levels	1 - 5.5 ns	1.8V, 2.5V, 3.3V and 5V	2.5 V $\leftrightarrow$ 1.8V - 5.5V
3.3 V	3.3 V Levels	5 - 7.1 ns	3.3 V Levels	1 - 2.9 ns	3.3 V Levels	1.5 - 4.2 ns	1.8V, 2.5V, 3.3V and 5V	3.3 V $\leftrightarrow$ 1.8V - 5.5V
5 V	5 V Levels	3.4 - 5.5 ns	5 V Levels	1 - 2.6 ns	5 V Levels	1 - 3.5 ns	1.8V, 2.5V, 3.3V and 5V	5 V $\leftrightarrow$ 1.8V - 5.5V

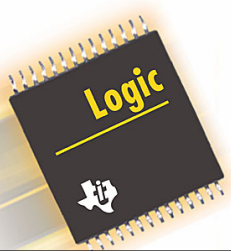

# Special “Dual-Supply” Level Shifters

**'3245 or '4245 pinout**

**Std '245 pinout**

**'3245 or '4245**

**Split Rail  
(Bidirectional Path)**

Device	V <sub>CCA</sub>	V <sub>CCB</sub>
LVC4245A	5V	2.7V, 3.3V
LVCC3245A	2.5V, 3.3V	3.3V, 5V
LVCC4245A	5V	2.7V - 5V
ALVC164245	2.7V, 3.3V	5V
AVCAH164245	1.5V - 3.3V	1.5V - 3.3V
AVCBH164245	1.5V - 3.3V	1.5V - 3.3V
AVCA164245	1.5V - 3.3V	1.5V - 3.3V
AVCB164245	1.5V - 3.3V	1.5V - 3.3V

**'164245†**

*\* This solution is compatible with a 3.3-V-only system. Devices can be replaced later with 3.3-V parts with minimal PCB redesign*

† equivalent to standard 16245 pinout.

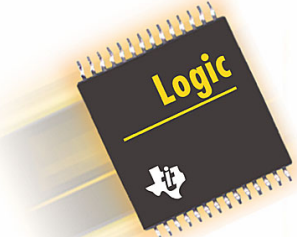

# What Is Little Logic?

## Single Gate/Dual Gate/Triple Gate

### The Principle

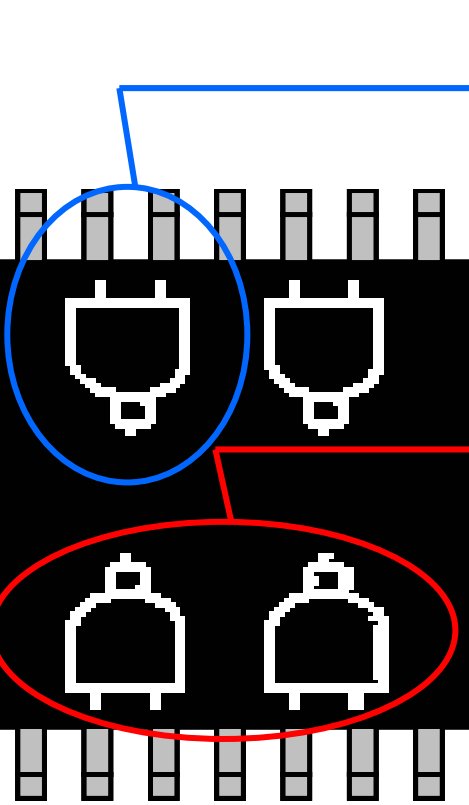

### Example

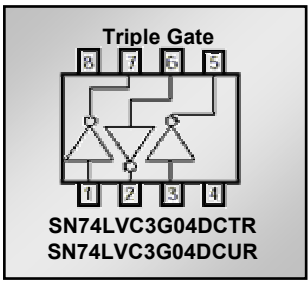
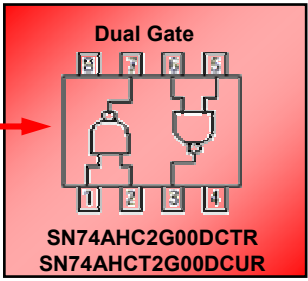
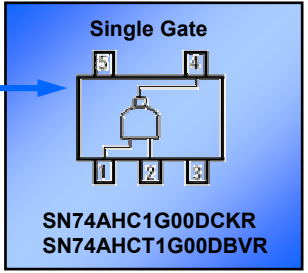

### Naming

SN74 LVC 1G xx YEP R

- ➔ **Tape & Reel**  
R = 3000 piece  
T = 250 piece
- ➔ **Package Type**  
YEA = NanoStar™ (170u)  
YEP = NanoStar™ (230u)  
YZA = NanoFree™ (170u)  
YZP = NanoFree™ (230u)
- DCK = SC-70  
DBV = SOT-23  
DCU = US-8  
DCT = SM-8
- ➔ **Logic Function**  
xx
- ➔ **Gate Count**  
1G - Single Gate  
2G - Dual Gate  
3G - Triple Gate
- ➔ **Product Family**  
AHC, AHCT, LVC,  
CBT, AUC

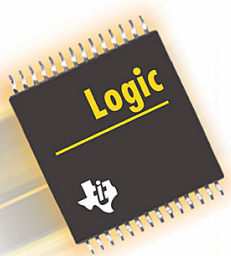

# Little Logic

## TI Portfolio

- Provides wide range of operating voltages (0.8V to 5.5V)
- World's first 1.8V optimized logic family (AUC) **NEW!**
- World's smallest Logic package solution (NanoStar™/NanoFree™)

<u>Family</u>	<u>Operating Voltage</u>	<u>Optimized Voltage</u>	<u>Prop Delay<sub>typ</sub></u>	<u>Output Drive</u>	<u>V<sub>i</sub> Tolerant</u>	<u>I<sub>off</sub></u>
AUC	0.8-2.7V	1.8V	2.0ns	8mA	3.6V	Yes
LVC	1.65-5.5V	3.3V	3.5ns	24mA	5.5V	Yes
AHC	2.0-5.5V	5.0V	5.0ns	8mA	5.5V	No
CBT	4.5-5.5V	5.0V	0.25ns	n/a	5.5V	n/a
CBTD	4.5-5.5V	5.0V	0.25ns	n/a	5.5V	n/a
CBTLV	2.3-3.6V	3.3V	0.25ns	n/a	3.6V	Yes

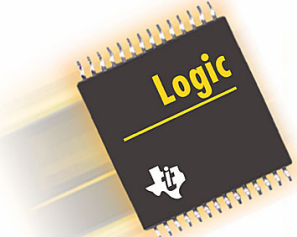

# NanoStar™/NanoFree™ Package

## The World's Smallest Logic Package

- Offered in SnPb (NanoStar) and Pb-free (NanoFree)
- Two solder bump sizes available (170u and 230u diameter)
- Bump locations facilitate device probing and rework
- 0.5-mm height meets aggressive LCD design requirements
- 70% smaller than industry standard SC-70 (DCK)
- 13% smaller than any other logic package available
- Improved thermal and electrical characteristics
- Targeted for space constrained, portable applications: Cellular, DVD/CD ROMs, DVC, Digital Watch, DSC, MD/MP3/CD players, notebook computers, PC cards and PDA's

Package Designators	
YEA	= SnPb Small Bump
YZA	= Pb Free Small Bump
YEP	= SnPb Large Bump
YZP	= Pb Free Large Bump

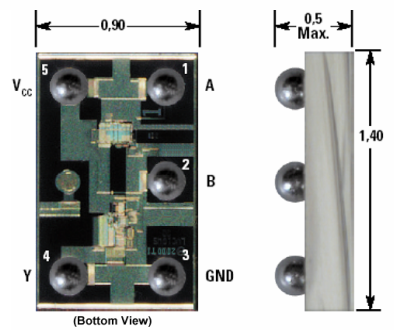

Package Area Configuration (0,5-mm Ball Pitch)

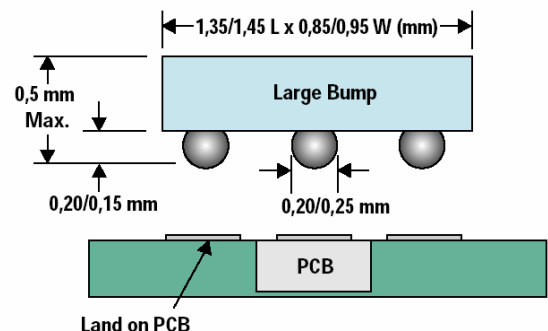
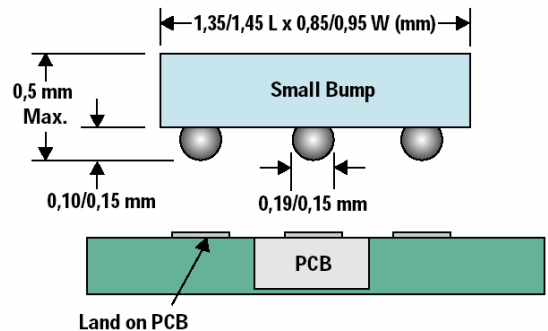

# AUC

## The World's First 1.8-V Logic

### Features

- 1.8-V Optimized Performance
- $V_{CC}$  Specified at 2.5 V, 1.8 V, 1.2 V
- 0.8 V Typical
- Balanced Drive
- 3.6-V I/O Tolerance
- Bus Hold Option
- $I_{OFF}$  Spec for Partial Power Down
- ESD Protection
- Low Noise
- Alternate -Source Agreements

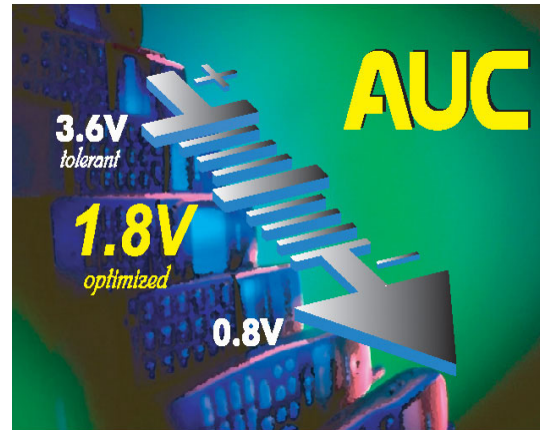

### Advanced Packaging

NanoStar™ YEA, YEP

NanoFree™ YZA, YZP 

 SOT 23 - DBV (Microgate)

 SC-70 - DCK (PicoGate)

TSSOP - PW & DGG

TVSOP - DGV

LFBGA - GKE, GKF

VFBGA - ZKE, ZKF 

VFBGA - GQL

VFBGA - ZQL 

QFN - RGY   

Device	$V_{CC}$	Drive	$T_{PD(MAX)}$
SN74AUC1G00	1.8 V	-8/8 mA	2.5 ns
SN74AUC16244	1.8 V	-8/8 mA	2.0 ns

Alternate Source: Philips, IDT



# AVC

Logic

## Features

- $V_{CC}$  Specified at 3.3 V, 2.5 V, 1.8 V
- 3.3-V I/O Tolerance
- Sub-2.0-ns max  $T_{pd}$  at 2.5 V
- Bus Hold Option
- $I_{OFF}$  for Partial Power Down
- Dynamic Output Control (DOC™)  
Circuit



## Advanced Packaging

SOIC - DW

TSSOP - PW, DGG

TVSOP - DGV

LFBGA - GKE, GKF

LFBGA - ZKE, ZKF

VFBGA - GQL

VFBGA - ZQL



LEAD-FREE



LEAD-FREE

Device	$V_{CC}$	Drive	$T_{PD(MAX)}$
SN74AVC16244	3.3 V	-12/12 mA (static)	1.7 ns
	2.5 V	-8/8 mA (static)	1.9 ns
	1.8 V	-4/4 mA (static)	3.2 ns

Alternate Source: Philips

DOC is a trademark of Texas Instruments.





# ALVC Family

## Features

- $V_{CC}$  Specified at 3.3 V, 2.5 V, and 1.8 V
- Balanced Drive
- Bus-Hold Option
- Drive Capability –6/12 mA at 2.5 V
- Low Noise
- Damping Resistor Options
- ESD Protection

## Advanced Packaging

**SOIC** - D and DW

**SSOP** - DB and DL

**TSSOP** - PW and DGG

**TVSOP** - DGV

**LFBGA** - GKE, GKF

**LFBGA** - ZKE, ZKF

**VFBGA** - GQL

**VFBGA** – ZQL



Device	$V_{CC}$	Drive	$T_{PD(MAX)}$
SN74ALVCH244	3.3 V	–24/24 mA	2.8 ns
SN74ALVCH16244	3.3 V	–24/24 mA	3.0 ns

## Literature

ALVC Low-Voltage CMOS Logic Data Book  
Lit # SCED006



## Alternate Source

ALVC: Philips, Hitachi, IDT  
VCX: Fairchild, ON, Toshiba

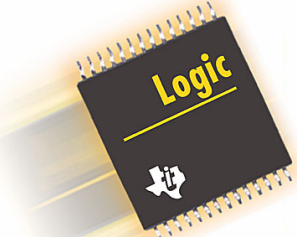

# LVC Family

## Features

- $V_{CC}$  Specified at 3.3 V, 2.5 V, and 1.8 V
- Balanced Drive
- 5-V I/O Tolerance
- Bus-Hold Option
- Series Damping Resistor Option
- $I_{OFF}$  Spec for Partial Power Down
- ESD Protection
- LVC $\underline{Z}$  has Power-Up 3-State for Hot Insertion

## Advanced Packaging

NanoStar™ - YEA, YEP

NanoFree™ - YZA, YZP 

SOT 23 - DBV (Microgate)

SC-70 - DCK (PicoGate)

SOIC - D and DW

SSOP - DB and DL

TSSOP - PW and DGG

TVSOP - DGV

LFBGA - GKE, GKF

LFBGA - ZKE, ZKF 

VFBGA - GQL

VFBGA - ZQL 

QFN - RGY



Device	$V_{CC}$	Drive	$T_{PD(MAX)}$
SN74LVCH244	3.3 V	-24/24 mA	5.9 ns
SN74LVCH16244	3.3 V	-24/24 mA	4.1 ns

### Literature

LVC Low-Voltage CMOS Logic Data Book  
LVC Designers Guide Application Report

Lit # SCBD152  
Lit # SDZAE16

### Alternate Source

LVC: Philips, Hitachi, IDT  
LCX: Fairchild, Motorola, Toshiba



-Z7

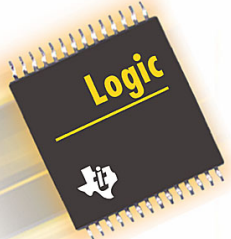

# LV-A Family

## Features

- $V_{CC}$  Specified at 5.0 V, 3.3 V, 2.5 V
- 5-V I/O Tolerance
- Balanced Drive
- $I_{OFF}$  Spec for Partial Power Down
- ESD Protection
- Low Noise

## Advanced Packaging



**SOIC** - D, DW

**SOP** - NS

**SSOP** - DB

**TSSOP** - PW, DGG

**TVSOP** - DGV

**QFN** - RGY, RGQ

Device	$V_{CC}$	Drive	$T_{PD(MAX)}$
SN74LV244A	5.0 V	-16/16 mA	6.5 ns
	3.3 V	-8/8 mA	10.0 ns

## Literature

LV Low-Voltage CMOS Logic Data Book  
Lit # SCBD152

## Alternate Source

LV: Philips, Hitachi  
LVQ: Fairchild, ON, Toshiba  
LVX: Fairchild, ON



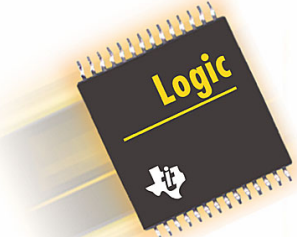

# LVT Family

## Features

- $V_{CC}$  Specified at 3.3 V
- High-Drive Output – up to 64 mA
- 5-V I/O Tolerance
- Bus Hold Option
- Partial Power Down ( $I_{OFF}$ )
- Power - Up 3-State ( $I_{OZPU}$ ,  $I_{OZPD}$ )
- Hot Insertion ( $I_{OFF}$  and PU3S)
- Low Noise
- Damping Resistor Options

## Advanced Packaging

- SOIC - DW
- SSOP - DB and DL
- TSSOP - PW and DGG
- TVSOP - DGV
- LFBGA - GKE and GKF
- LFBGA - ZKE and ZKF 
- VFBGA - GQL
- VFBGA - ZQL 

Device	$V_{CC}$	Drive	$T_{PD(MAX)}$
SN74LVTH244	3.3 V	-32/64 mA	3.5 ns
SN74LVTH16244	3.3 V	-32/64 mA	3.2 ns

## Literature

LVT Low-Voltage Technology Data Book  
 Lit # SCBD154  
 LVT-to-LVTH Conversion Application Report  
 On the Internet

## Alternate Source

LVT: Philips, Hitachi,  
 Fairchild\*, ON\*  
 \* *Similar Device, No Second-Source Agreement*





# ALVT Family

## Features

- $V_{CC}$  Specified at 3.3 V and 2.5 V
- High-Drive Output – up to 64 mA
- 5-V I/O Tolerance
- Power-Up 3-State ( $I_{OZPU}$ ,  $I_{OZPD}$ )
- Partial Power Down ( $I_{OFF}$ )
- Hot Insertion ( $I_{OFF}$  and PU3S)
- Bus Hold

## Advanced Packaging



Device	$V_{CC}$	Drive	$T_{PD(MAX)}$
SN74ALVTH16244	3.3 V	-32/64 mA	2.4 ns
	2.5 V	-8/24 mA	3.0 ns



## Literature

ALVT Low-Voltage Technology Data Book  
Lit # SCED003

## Second Source

ALVT: Philips

# Bus Switch - Functional Description

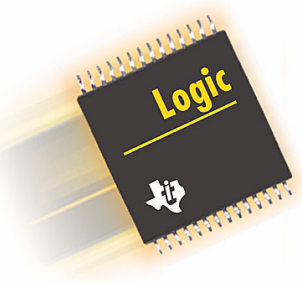

## What are Bus Switches?

- ★ Simple FET switches that can quickly turn ON / OFF the connection to a line or bus
- ★ Provide industry standard functions and pinouts (i.e. '244, '245) in a full range of bit widths (from 32-bit Widebus to 1-bit Little Logic)
- ★ Offer extremely low power consumption ( $\mu\text{A}$  range), ideal for portable systems
- ★ High performance replacements for standard Logic devices when signal buffering (current drive) is not required

## Bus Switch Circuit Diagram

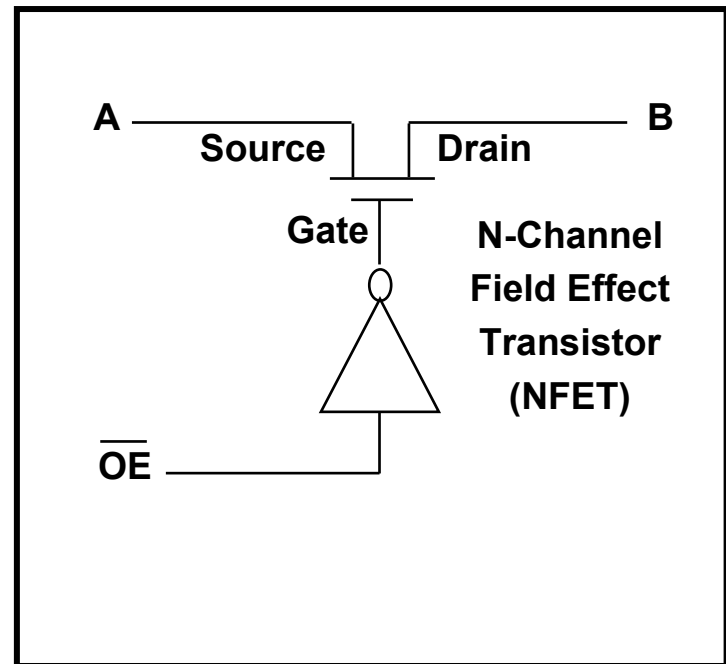

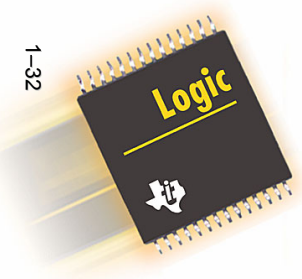

# Bus Switch - Key Characteristics

## When ON, a Bus Switch Provides

- Bidirectional Signal Passing
- Near Zero Propagation Delay (0.25ns) for maximum system performance
- Very Low Resistance ( $R_{on}$  about 5-10 Ohms)
- Very Low Capacitance ( $C_{io}$  about 8-12pF)
- Fast Data Throughput (supports signal frequencies up to 533MHz)
- No Drive Current (pass-through current only)

## When OFF, the Bus Switch Provides

- Excellent Isolation with very high Resistance ( $R_{on} = 100$ 's of MOhms)
- Ideal for Hot-Plug Applications
- Very Low Capacitance ( $C_{io}$  about 3-5pF) minimizes capacitive loading and signal distortion

## Bus Switch Circuit Diagram

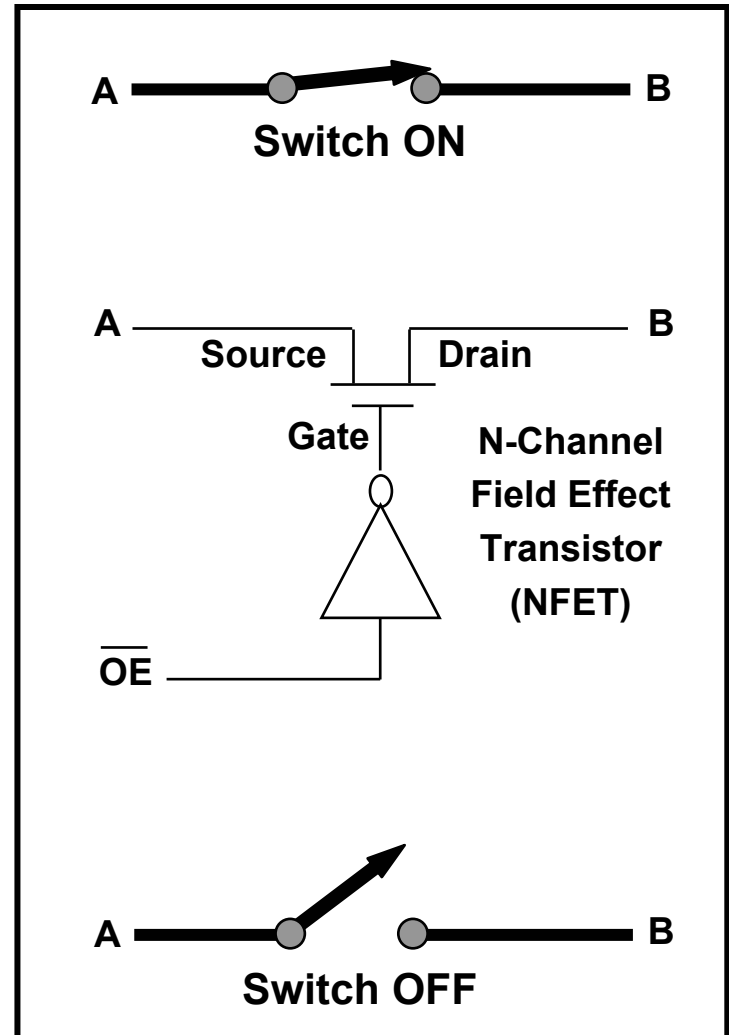

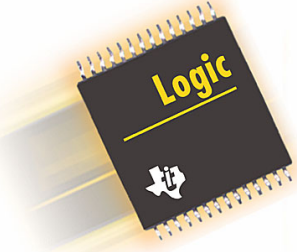

# Bus Switch - Architecture

## CBT Architecture

- NMOS switch uses NFET
- Supports 5V operation ( $V_{CC} = 4V - 5.5V$ )
- Switch ON when positive signal applied at gate ( $\overline{OE}$  low)
- Switch OFF when low signal applied at gate ( $\overline{OE}$  high)
- Bidirectional operation (Source & Drain interchangeable)
- CBTD = NMOS switch configured as level shifter with Level Shifting Diode

### NMOS Switch Circuit Diagram

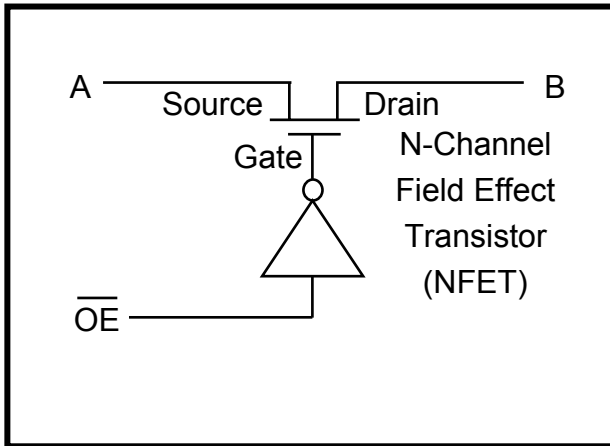

### NMOS Switch $V_{IN}/V_{OUT}$ Graph

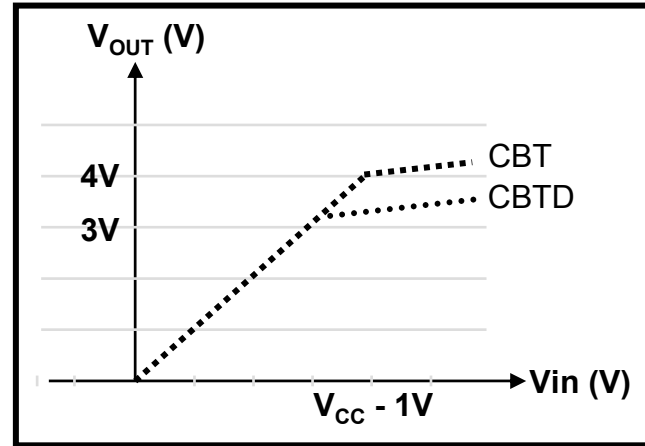



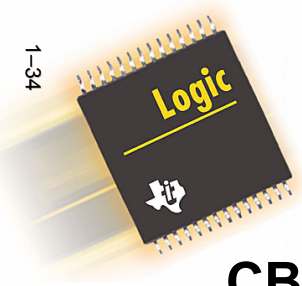

# Bus Switch - Architecture

## CBTLV Architecture

- CMOS Switch consisting of an NFET and PFET in parallel
- Supports 3.3V / 2.5V operation ( $V_{CC} = 2.3V - 3.6V$ )
- Switch ON when positive signal applied at NFET gate, and low signal applied at the PFET gate (OE low)
- Switch OFF when low signal applied at NFET gate, and positive signal applied at PFET gate (OE high)
- Bidirectional operation (source and drain interchangeable)
- Offers rail-to-rail signal transmission (no voltage clamping)

### CMOS Switch Circuit Diagram

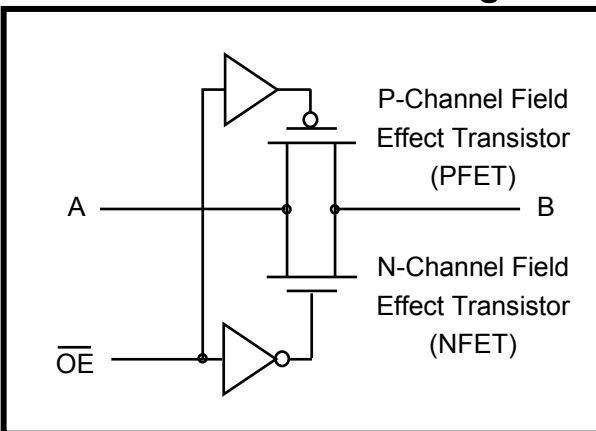

### CMOS Switch $V_{IN}/V_{OUT}$ Graph

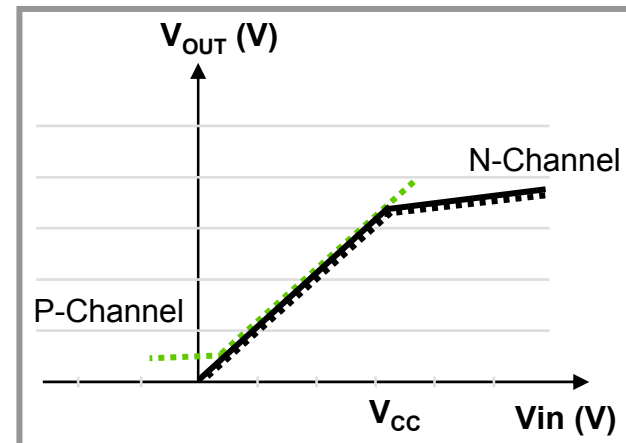

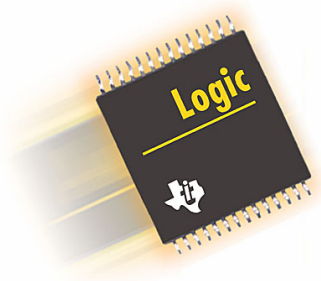

# Bus Switch – New Families

---

## CB3T

- 3.3V/2.5V Bus Switch with 5V Tolerant Level Shifter
- Supports Mixed-Mode Signal Operation On All Ports
  - 5V Input to 3.3V Output Level Shift with 3.3V Vcc
  - 5V and 3.3V Input to 2.5V Output Level Shift with 2.5V Vcc
- Low Icc Ideal for Notebooks, PDAs and Other Portable Products
- Ioff on A and B Ports for Partial-Power-Down Operation

## CB3Q

- 3.3V/2.5V Bus Switch with Charge Pump Technology
- Low and Flat Ron Characteristics Over Operating Range (4Ω Typical)
- Supports Rail-to-Rail Switching on Data I/O Ports
  - 0V to 5V Switching with 3.3V Vcc
  - 0V to 3.3V Switching with 2.5V Vcc
- Ioff on A and B Ports for Partial-Power-Down Operation
- Equivalent to the IDTQS3VH Product Family

# TVC

## Translation Voltage Clamp

logic diagram (positive logic)

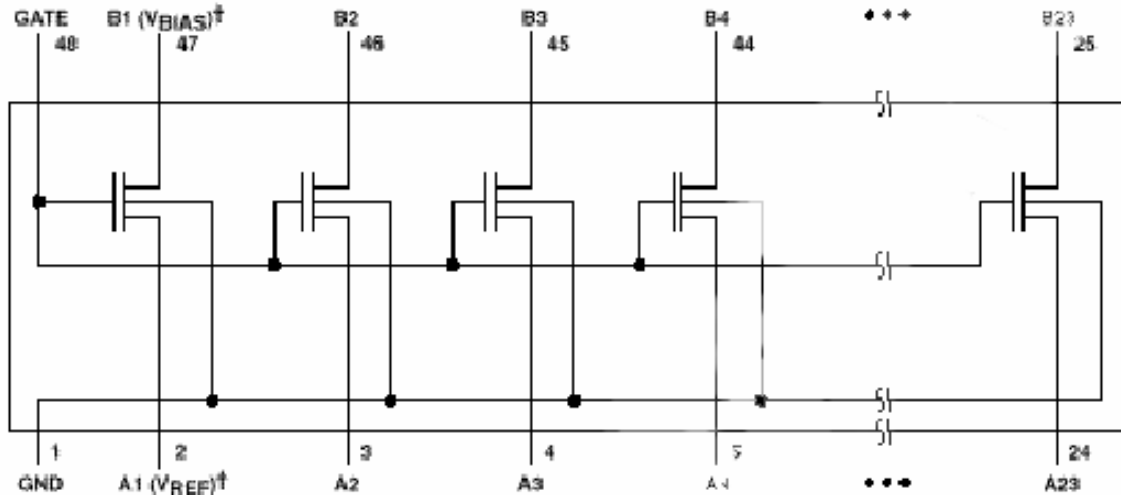

† The  $(V_{REF})$  and  $(V_{BIAS})$  may be applied to any one of the pass transistors. The GATE must be externally connected to the  $V_{BIAS}$ .

- Overshoot protection
- Voltage translator or a voltage clamp
- Abs 7 to -0.5V

<u>Device</u>	<u>Bit</u>
TVC3306	2
TVC3010	10
TVC16222A	22

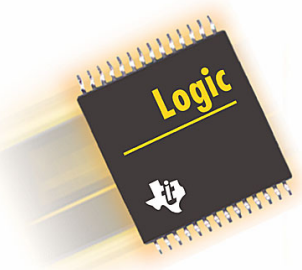

# What is GTL/GTLP?

- Open drain n-channel CMOS outputs. The pull-up resistor pulls the signal high and the device pulls the signal low
- Receiver stage is a differential input with external VREF. VREF is derived from a simple R/2R voltage divider of the termination voltage, V-TT
- GTLP enjoys increased noise margin over GTL
- GTLP edge rates have been optimized for distributed loads
- The reduced voltage swing reduces power consumption and EMI

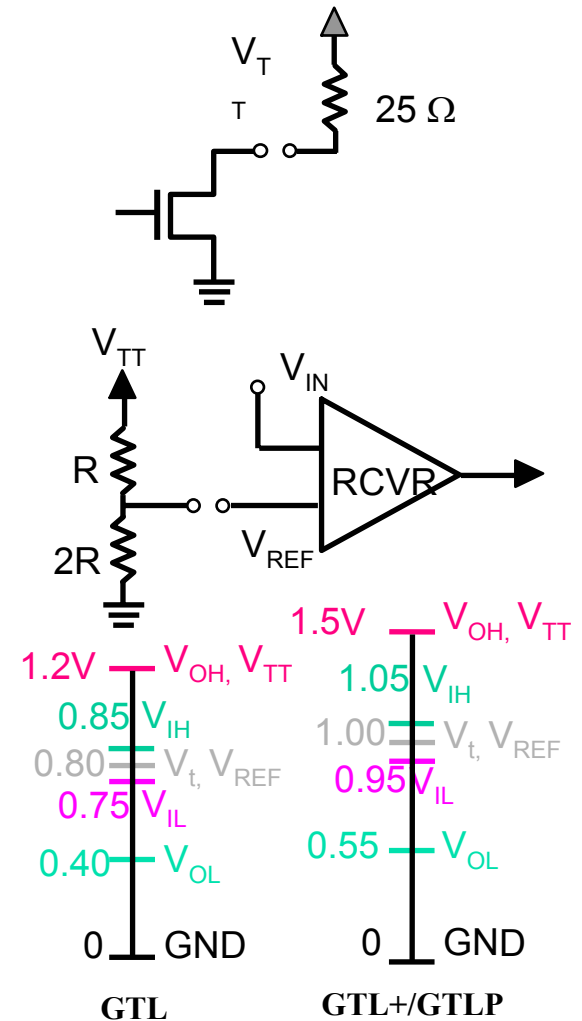

# GTLP Is a Bidirectional Translator



**CARD SIDE**

**BACKPLANE SIDE**

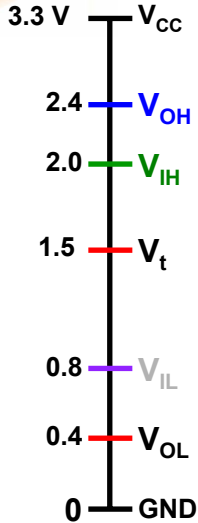

**DGG, DGV, OR DL PACKAGE  
(TOP VIEW)**

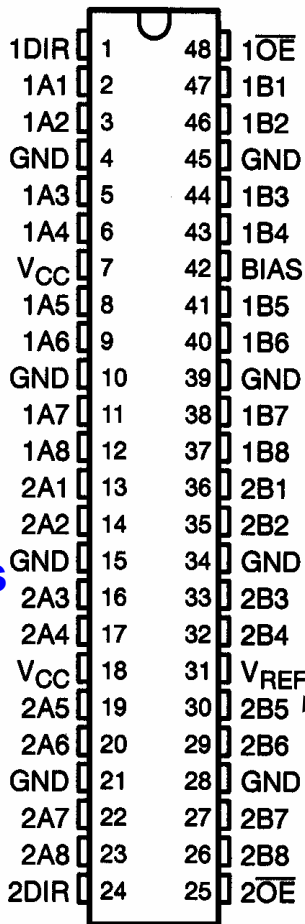

**TI-OPC™ Overshoot Protection Circuitry**

**OEC™ Improved Output Edge Control**

**Live Insertion**

**Reduced EMI**

**Edge Rate Control (ERC)**

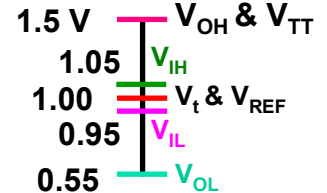

**LVTTL**  
**A Port and Control Pins**  
**3.3-V V<sub>CC</sub>**  
**5 V Tolerant**  
**Drive +/-24 mA**  
**Bus-Hold Option**  
**Flow-Through Pinout**

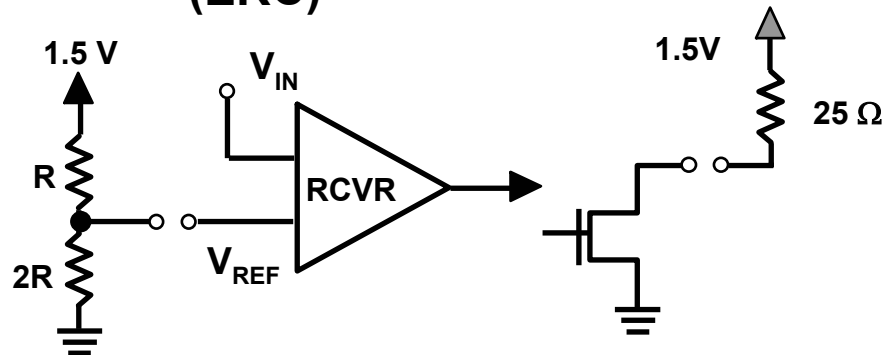

**Differential Input**

**Sink 50 mA or 100 mA**

**GTLP  
B Port**

# ***GTLP and VME Are Specifically Designed for High-Performance Multislot Parallel Backplanes***

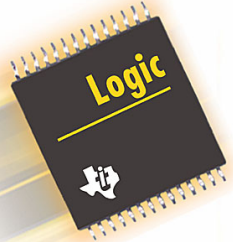

- **Mass Storage**
- **ISDN Remote Access**
- **Internet Routers**
- **ATM Switches**
- **Wireless Base Stations**
- **Flight Equipment**

## **GTLP**

- Open-drain technology
- Allows high frequencies (up to 100-MHz clock)
- Standard pinouts allow ease of migration from standard logic
- Improved signal integrity over standard logic

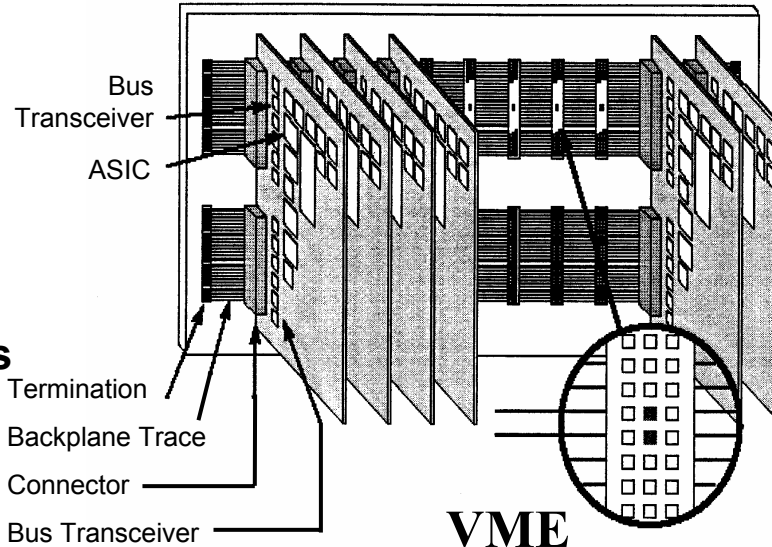

- **Industrial Controls**
- **Aerospace**
- **Transportation**
- **Medical**
- **Instrumentation Systems**

## **VME**

- Push-pull output structure
- Transmits data at 40 Mbit/s on legacy termination topologies
- Backward compatible to existing VME backplane
- Reduced input threshold for greater noise immunity

# GTLP

## Distributed-Load Devices

### Features

- CMOS
- 3.3-V  $V_{CC}$  – 5 V Tolerant
- $I_{off}$ , PU3S, and BIAS  $V_{CC}$
- Slow Edge Rates – ERC
- A Port
  - +/-24 mA – SDR +/-12 mA
  - Bus-Hold Option (on Die)
- B Port
  - $V_{TT}$  1.2 V to 2.1 V (BTL)
  - 100 mA (22- $\Omega$  Effective Characteristic Impedance)
  - TI-OPC
  - Low  $C_{IO}$

### Benefits

- ✓ Low Power Consumption
- ✓ Mixed Supply Capability
- ✓ Supports Live Insertion
- ✓ Reduced EMI
- ✓ A Port
  - ✓ Standard CMOS Output
  - ✓ No Need to Use Pullup/Pulldown
- ✓ B Port
  - ✓ Can Use GTLP in BTL Applications
  - ✓ High Drive for Heavily Loaded Systems
  - ✓ Improved Signal Integrity
  - ✓ Helps Live Insertion

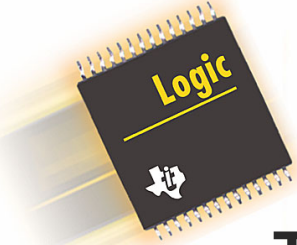

# SN74VMEH22501 UBT

## The VME Compatible Device for Low Voltage Environments

### Benefits:

- Extends life of VME characteristic bus
- Supports 2eVME and 2eSST protocols (VITA1.5)
- Increased noise immunity
- Supports transparent, latched or clocked mode
- 5-V tolerance at both ports
- Full live insertion capability with pre-charge
- Bus-hold and series resistors on A-Port
- Up to 320 MBps on standard VME backplane and up to 1 GBps on VME320 (star topology)

### Characteristics:

- Tighter input threshold ( $V_{CC}/2 \pm 50 \text{ mV}$ )
- -48/64 mA drive capability
- Huge AC pull-up/down drive capability to drive backplanes (slow edge rates)
- $BIAS-V_{CC}$  used to control pre-charge during live-insertion

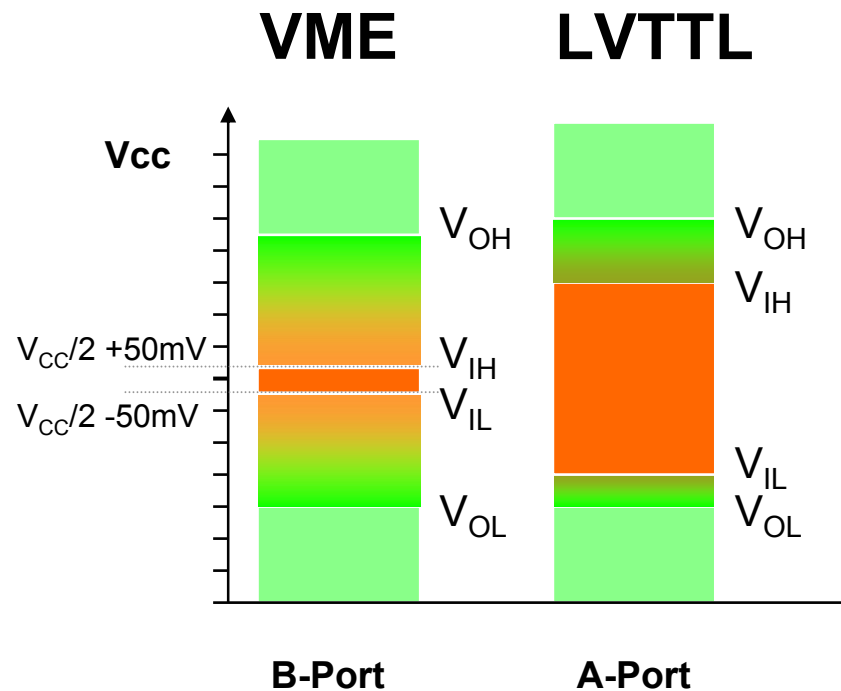

1-41



# Logic Roadmap for High-Speed Memory Interface

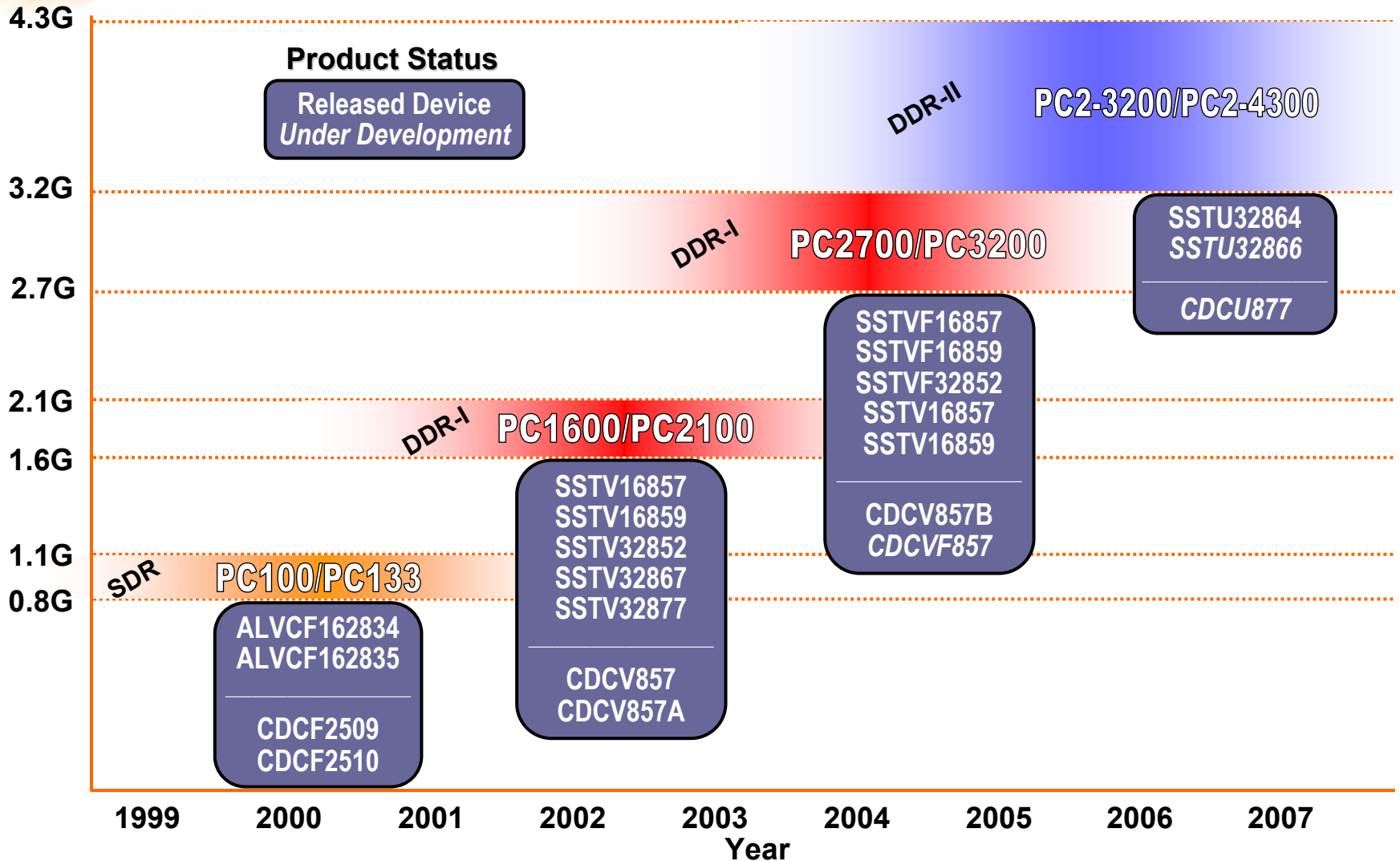

# DDR Register Solutions

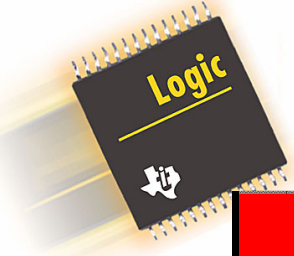

	DDR-I					DDR-II	
	PC1600/2100		PC2700		PC3200	PC2-3200	PC2-4300
	1.7"	1.2"	1.2"		1.2"	1.2"	1.2"
	TSOP DRAM	TSOP DRAM	TSOP DRAM	BGA DRAM	BGA DRAM	BGA DRAM	BGA DRAM
<b>1 Rank of x8</b>	 SSTV16857 TSSOP	 SSTV16857 TSSOP	 SSTVF16857 TSSOP	 SSTV16857 TSSOP	 SSTVF16859 QFN	2x SSTU32864 LFBGA SSTU32866 LFBGA	2x SSTU32864 LFBGA SSTU32866 LFBGA
<b>2 Rank of x8 1 Rank of x4</b>	 SSTV16857 TSSOP	 SSTV16857 TSSOP	 SSTVF16857 TSSOP	 SSTV16859 TSSOP	 SSTVF16859 QFN	2x SSTU32864 LFBGA SSTU32866 LFBGA	2x SSTU32864 LFBGA SSTU32866 LFBGA
<b>2 Rank of x4</b>	 SSTV16859 TSSOP	1x SSTV32852 LFBGA SSTV16859 QFN 	1x SSTVF32852 LFBGA SSTVF16859 QFN 	 SSTVF16859 TSSOP SSTVF16859 QFN 	No Solution	No Solution	No Solution

1-43

# Packaging Options

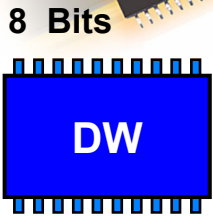
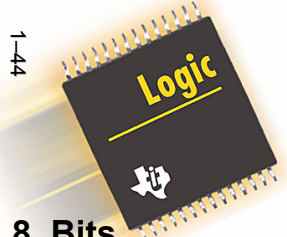

**8 Bits**  
**20-Pin SOIC**  
 Area = 137 mm<sup>2</sup>  
 Ht. = 2.65 mm  
 LP = 1.27 mm

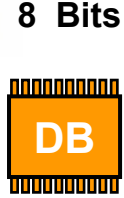

**8 Bits**  
**20-Pin SSOP**  
 Area = 62 mm<sup>2</sup>  
 Ht. = 2.0 mm  
 LP = 0.65 mm



**8 Bits**  
**20-Pin TSSOP**  
 Area = 46 mm<sup>2</sup>  
 Ht. = 1.1 mm  
 LP = 0.65 mm

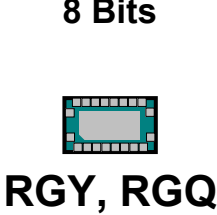

**8 Bits**  
**20-Pin QFN**  
 Area = 15.75mm<sup>2</sup>  
 Ht. = 0.9 mm  
 LP = 0.5mm

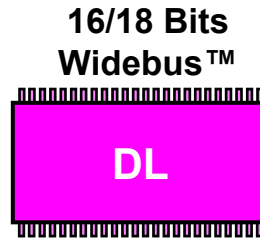

**16/18 Bits Widebus™**  
**48-Pin SSOP**  
 Area = 171 mm<sup>2</sup>  
 Ht. = 2.74 mm  
 LP = 0.635 mm



**16/18 Bits Shrink Widebus™**  
**48-Pin TSSOP**  
 Area = 108 mm<sup>2</sup>  
 Ht. = 1.1 mm  
 LP = 0.5 mm



**16/18 Bits Widebus™**  
**48-Pin TVSOP**  
 Area = 63 mm<sup>2</sup>  
 Ht. = 1.2 mm  
 LP = 0.4 mm

## Little Logic Packaging - 1G/2G/3G (magnified for detail)



**DBV**

**5/6-Pin SOT-23**  
 Area = 8.12 mm<sup>2</sup>  
 Ht. = 1.2 mm  
 LP = 0.95 mm

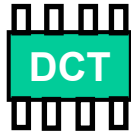

**8-Pin SOT**  
 Area = 8.26 mm<sup>2</sup>  
 Ht. = 1.3 mm  
 LP = 0.65 mm



**DCK**

**5/6-Pin SC-70**  
 Area = 4.2 mm<sup>2</sup>  
 Ht. = 1.0 mm  
 LP = 0.65 mm



**8-Pin SOT**  
 Area = 4.6 mm<sup>2</sup>  
 Ht. = 0.9 mm  
 LP = 0.5 mm



**YEA/YEP**  
**YZA/YZP**

**5/6-Pin DSBGA†**  
**NanoStar™/NanoFree™**  
 Area = 1.26 mm<sup>2</sup>  
 Ht. = 0.5 mm  
 LP = 0.5 mm



**YEA/YEP**  
**YZA/YZP**

**8-Pin DSBGA†**  
**NanoStar™/NanoFree™**  
 Area = 1.71 mm<sup>2</sup>  
 Ht. = 0.5 mm  
 LP = 0.5 mm

## 16/18 Bits MicroStar Jr.™



**GQL**  
**ZQL**



**56-Ball VFBGA**  
 Area = 31.5 mm<sup>2</sup>  
 Ht. = 1.0 mm  
 LP = 0.65 mm

## 32 Bits MicroStar™



**GKE**  
**ZKE**



**96-Ball LFBGA**  
 Area = 74.25 mm<sup>2</sup>  
 Ht. = 1.3 mm  
 LP = 0.8 mm

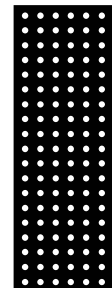

**GKF**  
**ZKF**



**114-Ball LFBGA**  
 Area = 88 mm<sup>2</sup>  
 Ht. = 1.3 mm  
 LP = 0.8 mm

NanoStar, MicroStar Jr., Widebus, and Shrink Widebus are trademarks of Texas Instruments. † DSBGA is the JEDEC reference for wafer chip scale package (WCSP).

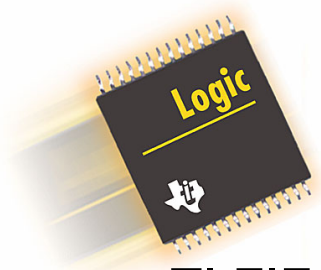

# TI FIFO Products

---

- TI FIFOs Provide Cost Effective “Pin-for-Pin Functional Equivalents” to IDT’s 18-bit and 36-bit Synchronous FIFOs
- TI DSP-Sync FIFOs Optimize DSP Performance in High Bandwidth Applications by Eliminating Data Bottlenecks
- TI DSP-Sync FIFOs provide a *DSP Glueless Interface* to Leading Edge TI TMS320™ DSPs
- TI Technology Leadership Creates World Class FIFO Performance with Industry's Fastest 3.3V FIFOs
- High Bandwidth Applications Include:
  - Wireless Base Stations
  - Remote Access Servers (RAS)
  - Digital Subscriber Line (DSL)
  - Network Security Cameras
  - Medical & Industrial Imaging
  - Multi-Channel Telephony
  - Gigabit-Ethernet Routers
  - ATM Switches & SONET/ATM Multiplexers

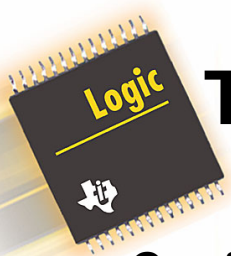

# TI FIFO Product and Technology Roadmap

## Configuration:

Performance (F Clock in MHz)

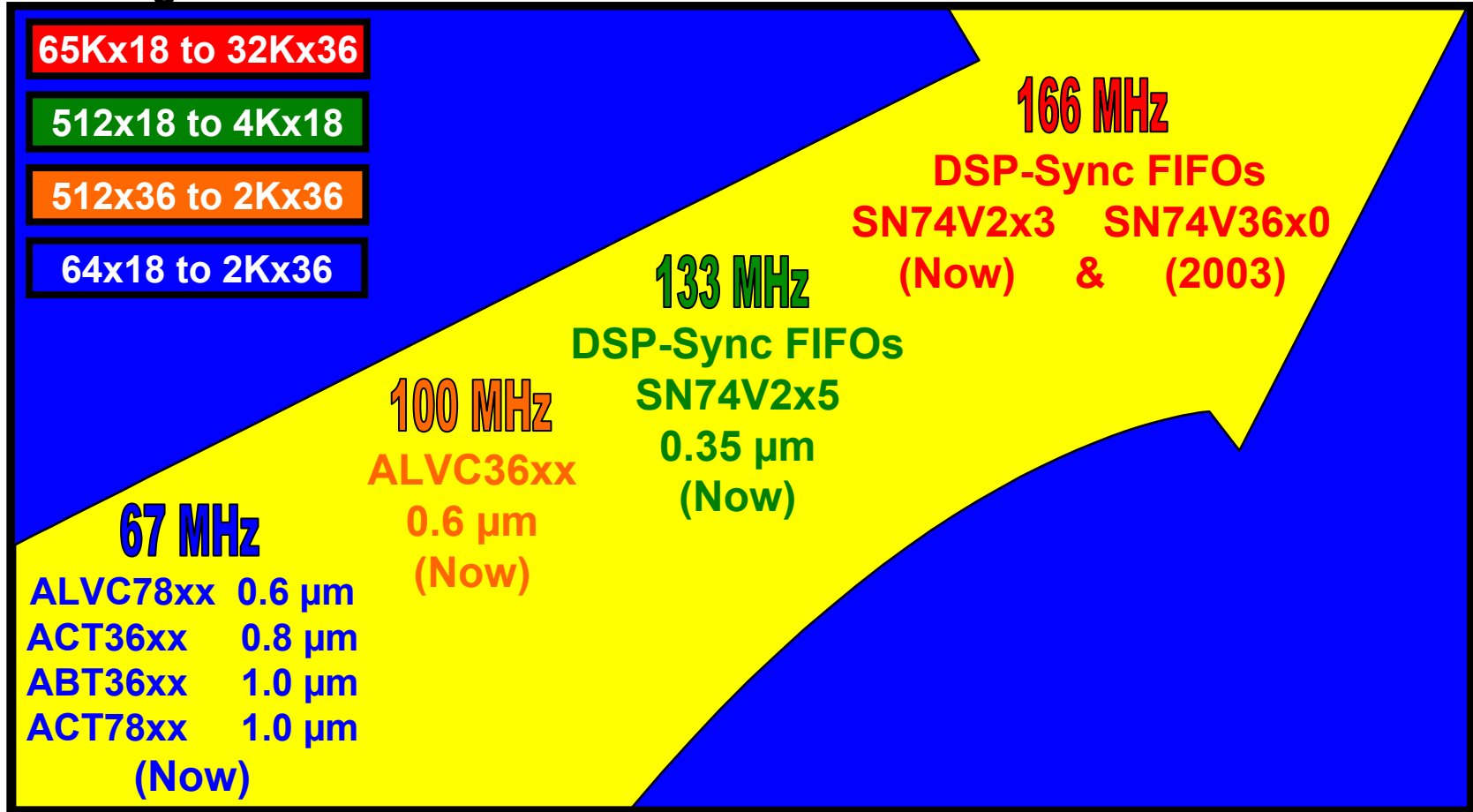

(Availability)

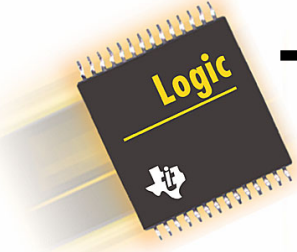

# TI FIFOs Optimize System Performance

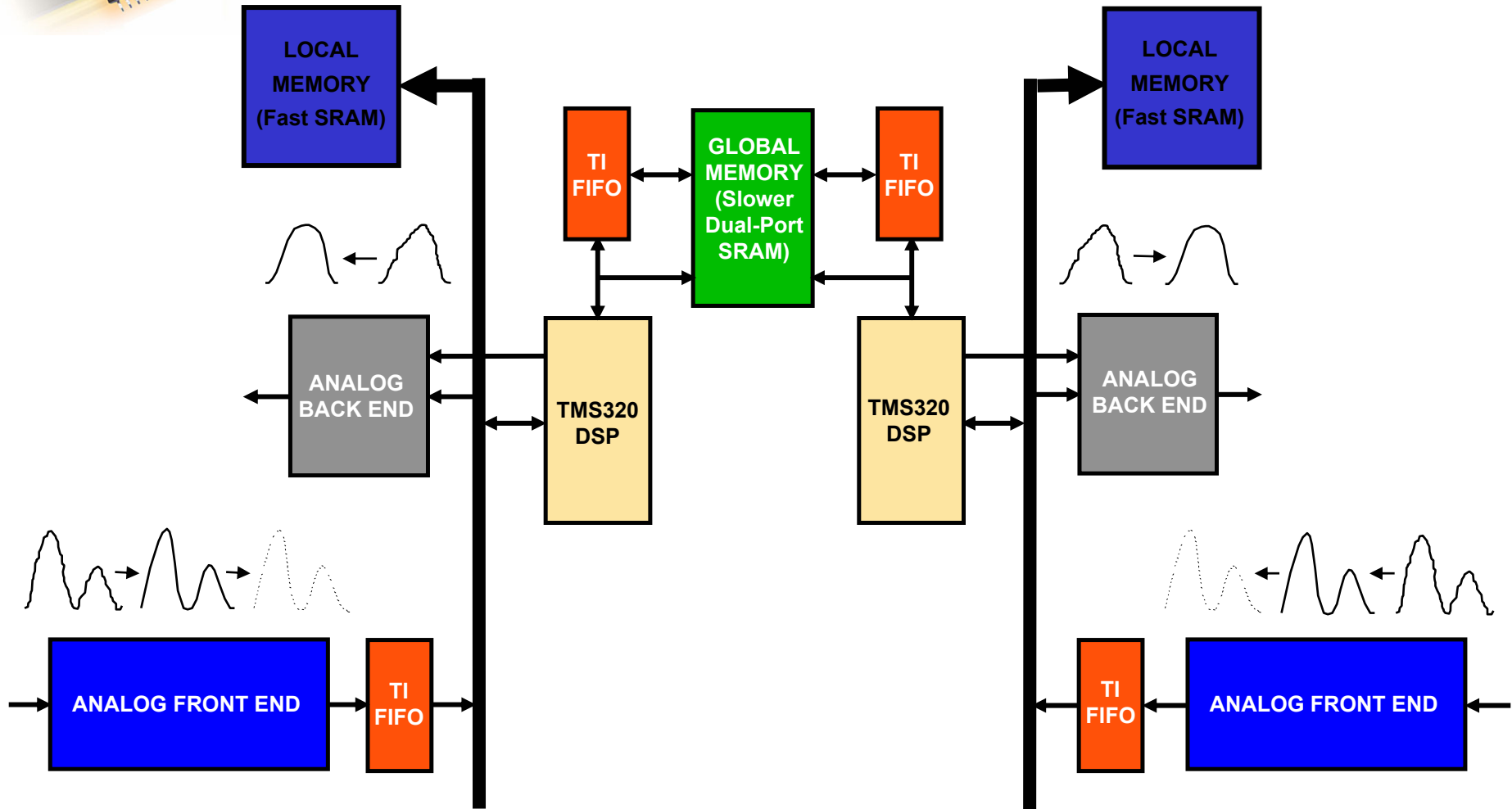

# IEEE 1149.1 (JTAG) Boundary-Scan Logic

## Generic IEEE 1149.1 functionality

- ◆ Between each I/O pin and the chip, there must be a boundary scan cell (BSC).
- ◆ All BSC's must be connected to the serial scan path, which functions like a shift register.
- ◆ The BSC's are controlled via four test control pins:
  - TCK (test clock)
  - TMS (test mode select)
  - TDI (test data input)
  - TDO (test data output)
- ◆ The BSC allows capturing data from and providing data to the chip data path.

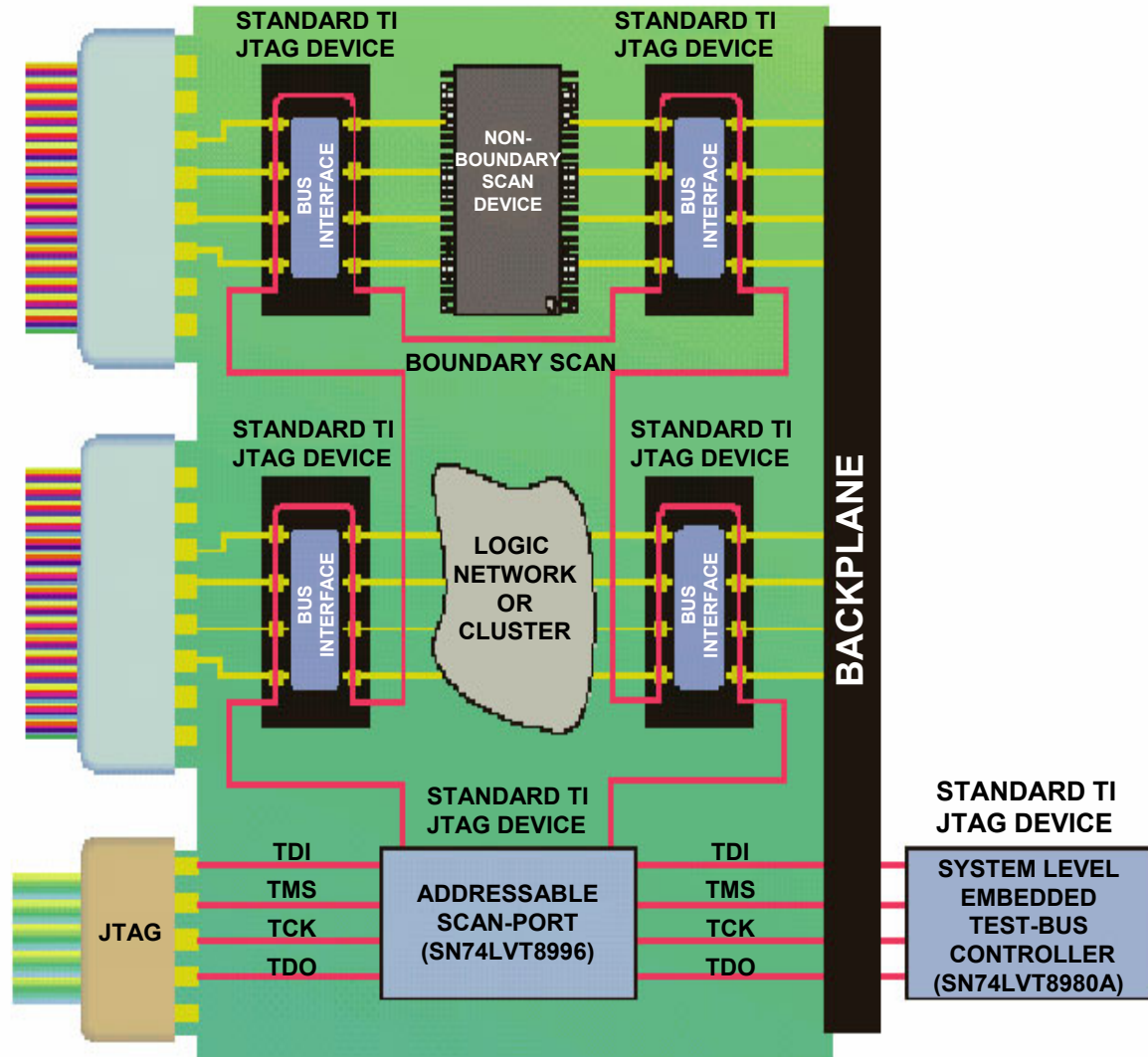

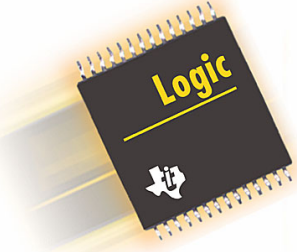

# Current TI JTAG Product Offering

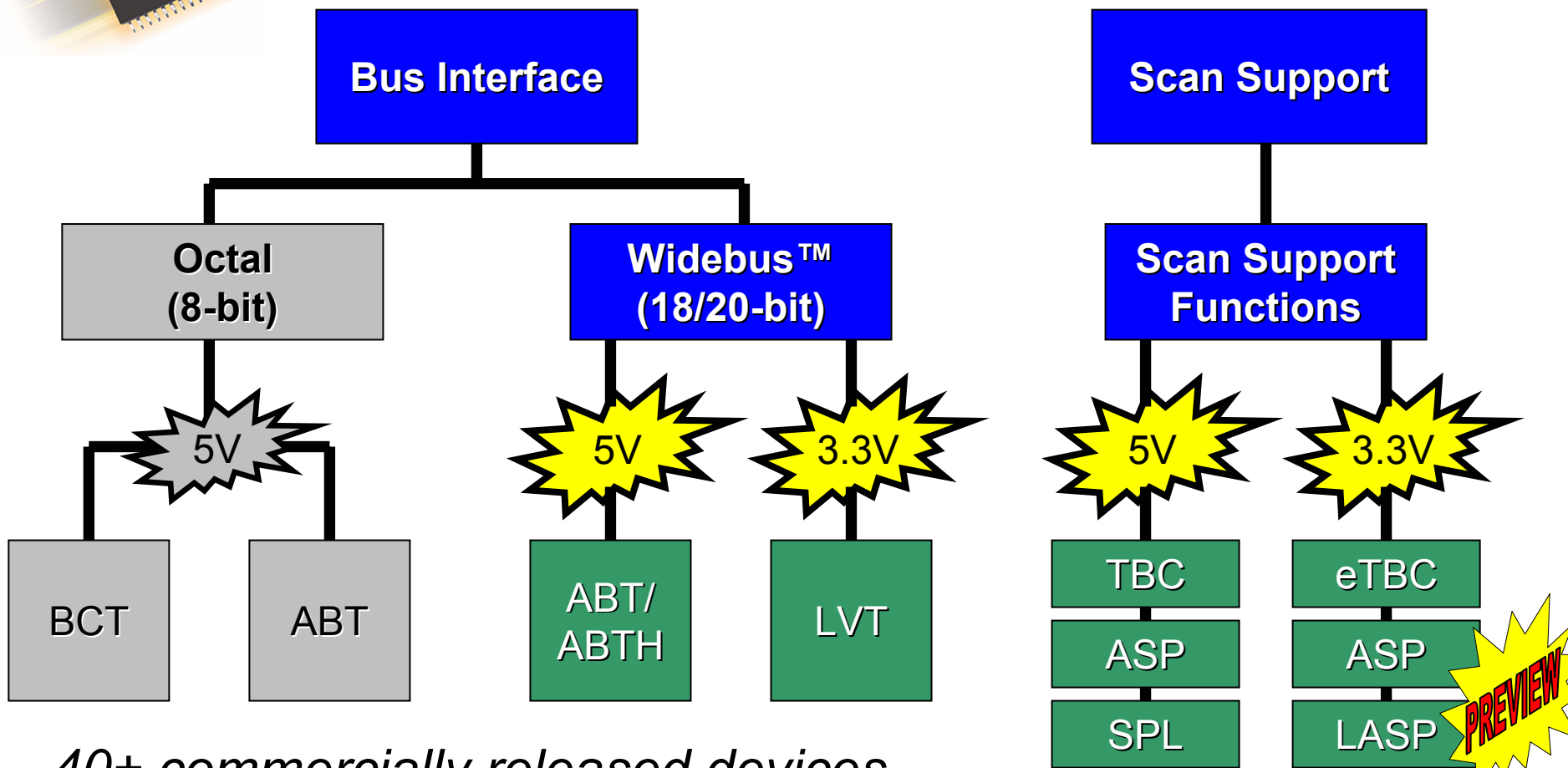

*40+ commercially released devices*

eTBC = embedded Test Bus Controller  
 ASP = Addressable Scan Port  
 LASP = Linking Addressable Scan Port  
 SPL = Scan Path Linker



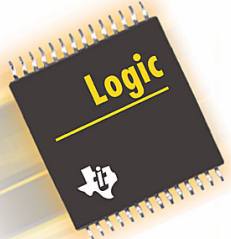

# Typical System-Level Application

## Active Backplane Multi-Drop Architectures

- ◆ eTBC converts parallel microprocessor instructions into serial JTAG commands through TMS and TCK
- ◆ eTBC addresses the correct target scan chain via ASP's
- ◆ ASP buffers/drives the JTAG scan commands into IEEE 1149.1 compliant devices

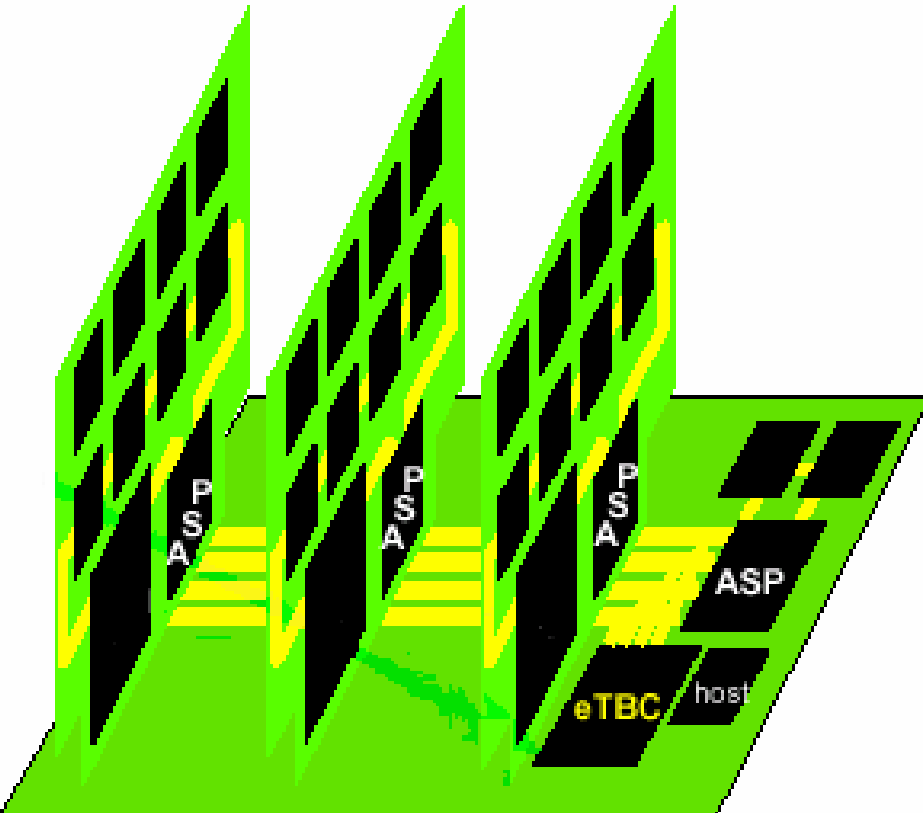

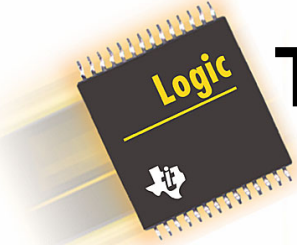

# Typical System-Level Application (Cont.)

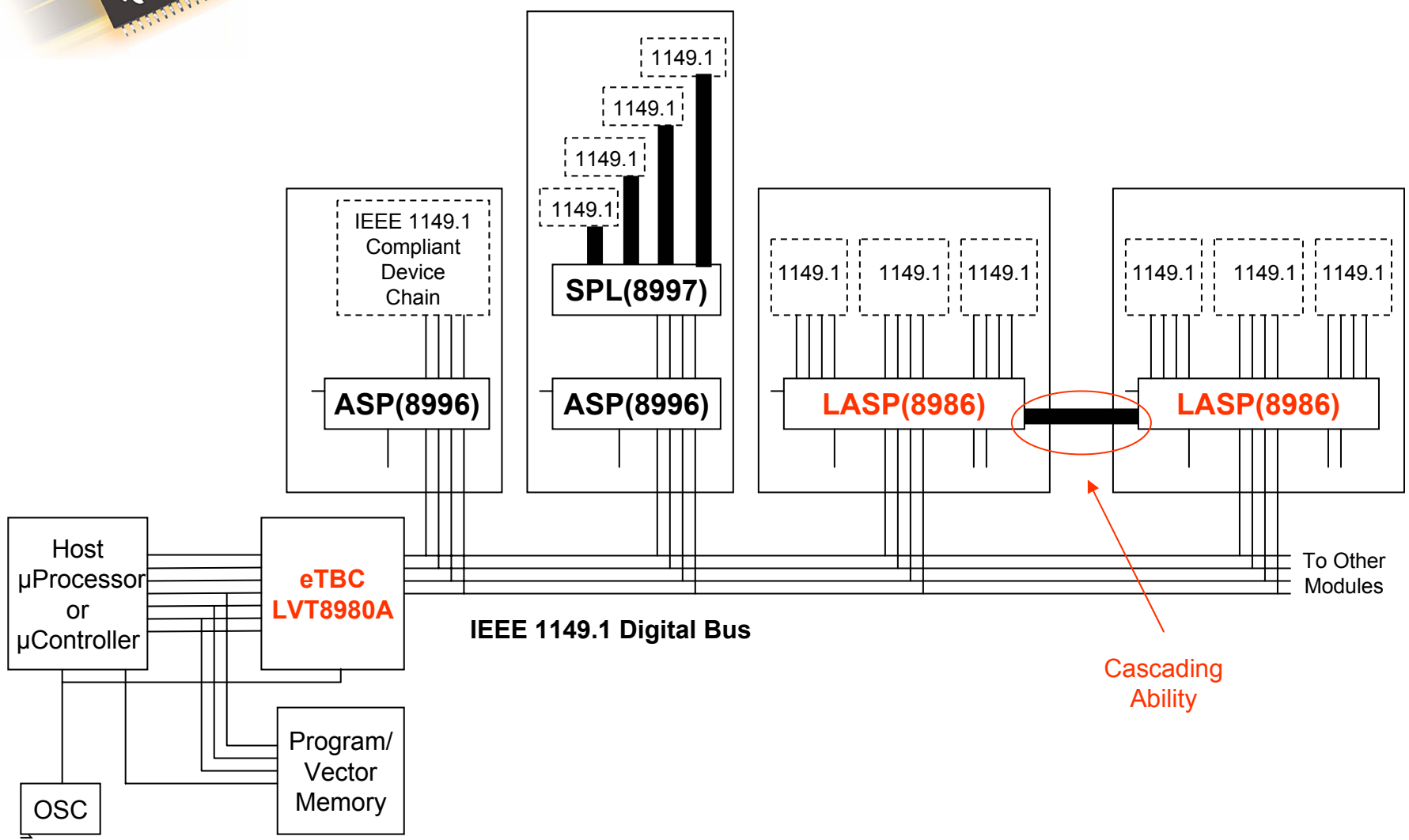

1-51



# Typical JTAG Applications

---

## Applications

- Manufacturing Board Level Test
  - Complex board assemblies (i.e. BGA packages)
- Manufacturing System Level Test
  - Fault Isolation rather than pass/fail
- Embedded System Level Test
  - Field testing or re-programming
- In System Programming(ISP)
  - Flash or PLD programming
- Emulation
  - eTBC (16-bit) used for DSP emulation/debug

<b>LOGIC OVERVIEW</b>	<b>1</b>
<b>FOCUS ON NAVIGATING THE TI LOGIC WEB</b>	<b>2</b>
<b>FUNCTIONAL INDEX</b>	<b>3</b>
<b>FUNCTIONAL CROSS-REFERENCE</b>	<b>4</b>
<b>DEVICE SELECTION GUIDE</b>	<b>5</b>
<b>PACKAGING AND MARKING INFORMATION</b>	<b>A</b>
<b>LOGIC PURCHASING TOOL/ALTERNATE SOURCES</b>	<b>B</b>

# 2

## FOCUS ON NAVIGATING THE TI LOGIC WEB

**SECTION 2**  
**FOCUS ON NAVIGATING THE TI LOGIC WEB**

---

**CONTENTS**

Web User Reference to Searching logic.ti.com .....	2-5
Web User Reference to Navigating logic.ti.com .....	2-6

# Web user reference to **Searching** logic.ti.com

## Searching: If you know the...

1. logic **Keyword** or **Phrase**
2. full or partial **Part Number**
3. **Voltage Node**
4. Logic **Function** (ie: buffer, gate, register)
5. Logic **Family** or **Product** (ie: ABT, LVT, SSTV)
6. **Top Side Marking** on Package

## Look here...

1. <http://logic.ti.com> – Search box (top right corner of page)
2. <http://logic.ti.com> – Search box (top right corner of page)
3. <http://logic.ti.com> – “Select a Voltage” (top left box)
4. <http://logic.ti.com> – “Logic Function Tree” tab (top center)
5. <http://logic.ti.com> – “Logic Product Tree” tab (top center)
6. <http://logic.ti.com> – “Logic Packaging” “Part Marking Lookup”



The screenshot displays the 'DIGITAL LOGIC FUNCTION TREE' page. At the top, there are three tabs: 'LOGIC FUNCTION TREE' (selected), 'LOGIC PRODUCT TREE', and 'SELECTION MATRIX'. The main content area is a table listing various logic functions, each with a 'Product List' and 'Parametric Table' link. The functions are categorized into sections: Backplane Logic (GTL, GTLP, FB/FB+, ABTE/ETL), Boundary Scan (JTAG) Logic, Buffers and Drivers, Counters, Decoders/Encoders/Multiplexers, and FIFOs. On the left side, there is a 'Select Logic Devices by:' section with a 'Select a Voltage' dropdown menu and a 'GO' button, and an 'Enter (Partial) Device #' input field with a 'SEARCH' button. On the right side, there are three sidebar sections: 'RELATED PRODUCTS' (listing Military, Automotive, DSP, Analog), 'DEVELOPMENT SUPPORT' (listing Logic KnowledgeBase), and 'WHAT'S NEW' (listing TI is the First Supplier with Logic Register Components for Evaluation in DDR-II DIMM Designs, and Press Releases).

Category	Sub-category	Product List	Parametric Table
Backplane Logic (GTL, GTLP, FB/FB+, ABTE/ETL)	Backplane Logic (GTL, GTLP, FB/FB+, ABTE/ETL)	<a href="#">Product List</a>	<a href="#">Parametric Table</a>
	Boundary Scan (JTAG) Logic		
Boundary Scan (JTAG) Logic	Boundary Scan (JTAG) Bus Devices	<a href="#">Product List</a>	<a href="#">Parametric Table</a>
	Boundary Scan (JTAG) Support Devices	<a href="#">Product List</a>	<a href="#">Parametric Table</a>
Buffers and Drivers	Inverting Buffers and Drivers	<a href="#">Product List</a>	<a href="#">Parametric Table</a>
	Non-Inverting Buffers and Drivers	<a href="#">Product List</a>	<a href="#">Parametric Table</a>
Counters	Binary Counters	<a href="#">Product List</a>	<a href="#">Parametric Table</a>
	Decade Counters	<a href="#">Product List</a>	<a href="#">Parametric Table</a>
Decoders/Encoders/Multiplexers	Decoders	<a href="#">Product List</a>	<a href="#">Parametric Table</a>
	Multiplexers	<a href="#">Product List</a>	<a href="#">Parametric Table</a>
	Priority Encoders	<a href="#">Product List</a>	<a href="#">Parametric Table</a>
FIFOs	Asynchronous FIFOs	<a href="#">Product List</a>	<a href="#">Parametric Table</a>
	Synchronous FIFOs	<a href="#">Product List</a>	<a href="#">Parametric Table</a>

**Web user reference to [Navigating logic.ti.com](http://www.logic.ti.com)**  
**For technical support please contact the Product Information Center at (972) 644-5580**

**Support Tools & Other Web Features**

1. New Product & Package Releases
2. Logic Packaging Information  
(advanced packaging, tape & reel, lead-free, etc.)
3. Cross References  
(find TI equivalent devices to other logic manufacturers)
4. Logic eNews (sent out once a month)
5. Product Change Notifications (PCN's)
6. Application Notes (sorted by Logic family)
7. Data Sheets (for a specific Logic part number)
8. Data Sheets (across a certain Logic family)
9. IBIS Models (sorted by Logic family)
10. SPICE Models (sorted by Logic family)
11. Logic Literature (electronic download or online order form)
12. Logic Samples (for a specific Logic part number)
13. Logic Samples (for all Logic devices)
14. Logic KnowledgeBase
15. Logic Press Releases

**Look here...**

1. <http://logic.ti.com> – “Products” container    “New Products”
2. <http://logic.ti.com> – “Products” container    “Logic Packaging”
3. <http://logic.ti.com> – “About Logic” container    “Cross Reference Search”  
or <http://www.ti.com/logiccrossref>
4. <http://logic.ti.com> – “About Logic” container    “Logic Newsletter”
5. <http://logic.ti.com> – “About Logic” container    “PCN Service”
6. <http://logic.ti.com> – “Technical Documents” container    “App Notes”
7. <http://logic.ti.com> – Part Number Search    Product Folder    “Datasheet”
8. <http://logic.ti.com> – “Technical Documents” container    “Data Sheets”
9. <http://logic.ti.com> – “Technical Documents” container    “IBIS Models”
10. <http://logic.ti.com> – “Technical Documents “ container    “Spice Models”
11. <http://logic.ti.com> – “Technical Documents” container    “Logic Literature”
12. <http://logic.ti.com> – Part Number Search    Product Folder    “Samples”
13. <http://logic.ti.com> – “How to Purchase” container    “Samples”
14. <http://logic.ti.com> – “Development Support” container    “Logic KBase”  
or <http://www.ti.com/logickb>
15. <http://logic.ti.com> – “What’s New” container    “Press Releases”



<b>LOGIC OVERVIEW</b>	<b>1</b>
<b>FOCUS ON NAVIGATING THE TI LOGIC WEB</b>	<b>2</b>
<b>FUNCTIONAL INDEX</b>	<b>3</b>
<b>FUNCTIONAL CROSS-REFERENCE</b>	<b>4</b>
<b>DEVICE SELECTION GUIDE</b>	<b>5</b>
<b>PACKAGING AND MARKING INFORMATION</b>	<b>A</b>
<b>LOGIC PURCHASING TOOL/ALTERNATE SOURCES</b>	<b>B</b>

# 3

## FUNCTIONAL INDEX

## SECTION 3 FUNCTIONAL INDEX

---

### CONTENTS

Backplane Logic (GTL, GTLP, FB+/BTL, and ABTE/ETL) .....	3-5
Drivers and Transceivers .....	3-5
Boundary-Scan IEEE Std 1149.1 (JTAG) Logic .....	3-6
Boundary-Scan (JTAG) Bus Devices .....	3-6
Boundary-Scan (JTAG) Support Devices .....	3-7
Buffers and Drivers .....	3-7
Inverting Buffers and Drivers .....	3-7
Noninverting Buffers and Drivers .....	3-9
Bus Switches .....	3-12
Bus Exchange/Multiplexing Switches .....	3-12
Standard Bus Switches .....	3-12
Counters .....	3-14
Binary Counters .....	3-14
Decade Counters .....	3-15
Decoders, Encoders, and Multiplexers .....	3-16
Decoders .....	3-16
Multiplexers .....	3-17
Priority Encoders .....	3-18
FIFOs (First-In, First-Out Memories) .....	3-19
Asynchronous FIFO Memories .....	3-19
Synchronous FIFO Memories .....	3-20
Flip-Flops .....	3-21
D-Type Flip-Flops (3-state) .....	3-21
D-Type Flip-Flops (non 3-state) .....	3-23
Other Flip-Flops .....	3-23
Gates and Inverters .....	3-24
AND Gates .....	3-24
NAND Gates .....	3-24
AND-OR-Invert Gates .....	3-26
OR Gates .....	3-26
NOR Gates .....	3-27
Exclusive-OR Gates .....	3-27
Exclusive-NOR Gates .....	3-28
Gate and Delay Elements .....	3-28
Inverters .....	3-29
Latches .....	3-30
D-Type Latches (3-state) .....	3-30
Other Latches .....	3-31

---

## CONTENTS (continued)

Little Logic .....	3-31
AND Gates .....	3-31
NAND Gates .....	3-32
OR Gates .....	3-32
NOR Gates .....	3-32
Exclusive-OR Gates .....	3-32
D-Type Flip-Flops .....	3-33
Decoders .....	3-33
Inverters .....	3-33
Inverting Buffers and Drivers .....	3-34
Noninverting Buffers and Drivers .....	3-34
Multiplexers .....	3-34
Specialty Logic .....	3-35
Standard Bus Switches .....	3-35
Memory Drivers and Transceivers (HSTL, SSTL, SSTU, and SSTV/SSTVF) .....	3-35
Buffers, Drivers, and Latches .....	3-35
Registers .....	3-36
Registers .....	3-36
Specialty Logic .....	3-37
Adders .....	3-37
Arithmetic Logic Units .....	3-37
Bus-Termination Arrays and Networks .....	3-37
Comparators (identity) .....	3-38
Comparators (magnitude) .....	3-38
Digital Phase-Locked Loops (PLLs) .....	3-38
Drivers/Multipliers .....	3-38
ECL/TTL Functions .....	3-39
Frequency Dividers/Timers .....	3-39
I <sup>2</sup> C Functions .....	3-39
Little Logic .....	3-39
Monostable Multivibrators .....	3-40
Oscillators .....	3-40
Parity Generators and Checkers .....	3-40
Translation Voltage Clamps .....	3-41
Voltage-Level Shifters .....	3-41
Transceivers .....	3-41
Parity Transceivers .....	3-41
Registered Transceivers .....	3-42
Standard Transceivers .....	3-43
Universal Bus Functions .....	3-47
Universal Bus Transceivers .....	3-47
Universal Bus Drivers .....	3-48
Universal Bus Exchangers .....	3-48

✓ Product available in technology indicated • Product available in reduced-noise advanced CMOS (11000 series) ✚ New product planned in technology indicated  
 CP = center pin OC = open collector OD = open drain 3S = 3-state

## BACKPLANE LOGIC (GTL, GTLP, FB+/BTL, AND ABTE/ETL)

### Drivers and Transceivers

DESCRIPTION	TYPE	TECHNOLOGY				
		ABTE	FB	GTL	GTLP	VME
1:6/1:2 GTLP-to-LVTTL Fanout Drivers	817				✓	
Dual 1-Bit LVTTTL-to-GTLP Adjustable-Edge-Rate Bus Transceivers with Split LVTTTL Port, Feedback Path, and Selectable Polarity	1395				✓	
	21395				✓	
2-Bit LVTTTL-to-GTLP Adjustable-Edge-Rate Bus Transceivers with Selectable Polarity	1394				✓	
7-Bit TTL/BTL Transceivers (IEEE Std 1194.1)	2041		✓			
8-Bit LVTTTL-to-GTLP Adjustable-Edge-Rate Registered Transceivers with Split LVTTTL Port and Feedback Path	22033				✓	
	2034				✓	
	22034				✓	
8-Bit LVTTTL-to-GTLP Bus Transceivers	306				✓	
8-Bit TTL/BTL Registered Transceivers (IEEE Std 1194.1)	2033		✓		✓	
8-Bit TTL/BTL Transceivers (IEEE Std 1194.1)	2040		✓			
8-Bit Universal Bus Transceivers and Two 1-Bit Bus Transceivers with 3-State Outputs	22501					✓
9-Bit TTL/BTL Address/Data Transceivers (IEEE Std 1194.1)	2031		✓			
11-Bit Incident Wave Switching Bus Transceivers with 3-State and Open-Collector Outputs	16246	✓				
16-Bit LVTTTL-to-GTLP Adjustable-Edge-Rate Bus Transceivers	1645				✓	
16 Bit LVTTTL-to-GTL/GTL+ Universal Bus Transceivers with Live Insertion	1655			✓		
16 Bit LVTTTL-to-GTLP Adjustable-Edge-Rate Universal Bus Transceivers	1655				✓	
16-Bit Incident Wave Switching Bus Transceivers with 3-State Outputs	16245	✓				
16-Bit LVTTTL-to-GTLP Bus Transceivers	16945				✓	
17-Bit LVTTTL-to-GTL/GTL+ Universal Bus Transceivers with Buffered Clock Outputs	16616			✓		
17-Bit LVTTTL-to-GTLP Universal Bus Transceivers with Buffered Clock	16916				✚	
17-Bit LVTTTL-to-GTLP Adjustable-Edge-Rate Universal Bus Transceivers with Buffered Clock	1616				✓	
17-Bit TTL/BTL Universal Storage Transceivers with Buffered Clock Lines (IEEE Std 1194.1)	1651		✓			
17-Bit LVTTTL/BTL Universal Storage Transceivers with Buffered Clock Lines (IEEE Std 1194.1)	1653		✓			
18-Bit TTL/BTL Universal Storage Transceivers (IEEE Std 1194.1)	1650		✓			
18-Bit LVTTTL-to-GTLP Adjustable-Edge-Rate Universal Bus Transceivers	1612				✓	
18-Bit LVTTTL-to-GTL/GTL+ Universal Bus Transceivers	16612			✓		

## BACKPLANE LOGIC (GTL, GTLP, FB+/BTL, AND ABTE/ETL)

### Drivers and Transceivers (continued)

DESCRIPTION	TYPE	TECHNOLOGY				
		ABTE	FB	GTL	GTLP	VME
18-Bit LVTTTL-to-GTLP Universal Bus Transceivers	16612				✓	
	16912				✓	
18-Bit LVTTTL-to-GTL/GTL+ Bus Transceivers	16622			✓		
	16923			✓		
18-Bit LVTTTL-to-GTLP Bus Transceivers with Source-Synchronous Clock Outputs	16927				✓	
32-Bit LVTTTL-to-GTLP Adjustable-Edge-Rate Bus Transceivers	3245				✓	
32-Bit LVTTTL-to-GTLP Bus Transceivers	32945				✓	
34-Bit LVTTTL-to-GTLP Universal Bus Transceivers	32916				✓	
36-Bit LVTTTL-to-GTLP Universal Bus Transceivers	32912				✓	

## BOUNDARY-SCAN IEEE STD 1149.1 (JTAG) LOGIC

### Boundary-Scan (JTAG) Bus Devices

DESCRIPTION	OUTPUT	TYPE	TECHNOLOGY		
			ABT	BCT	LVT
Scan-Test Devices with Octal Transceivers	3S	8245	✓	✓	
Scan-Test Devices with 18-Bit Bus Transceivers		18245	✓		
Scan-Test Devices with 18-Bit Inverting Bus Transceivers		18640	✓		
Scan-Test Devices with 18-Bit Transceivers and Registers	3S	18646	✓		✓
		182646	✓		✓
		18652	✓		✓
		182652	✓		✓
Scan-Test Devices with 18-Bit Universal Bus Transceivers	3S	18502	✓		✓
		182502	✓		✓
		18512			✓
Scan-Test Devices with 20-Bit Universal Bus Transceivers	3S	182512			✓
		18504	✓		✓
		182504	✓		✓
		18514			✓

**Boundary-Scan (JTAG) Bus Devices (continued)**

DESCRIPTION	OUTPUT	TYPE	TECHNOLOGY		
			ABT	BCT	LVT
Scan-Test Devices with Octal Buffers	3S	8240		✓	
		8244		✓	
Scan-Test Devices with Octal Bus Transceivers and Registers	3S	8646	✓		
		8652	✓		
Scan-Test Devices with Octal D-Type Latches	3S	8373		✓	
Scan-Test Devices with Octal D-Type Edge-Triggered Flip-Flops	3S	8374		✓	
Scan-Test Devices with Octal Registered Bus Transceivers		8543	✓		
		8952	✓		

**Boundary-Scan (JTAG) Support Devices**

DESCRIPTION	OUTPUT	TYPE	TECHNOLOGY		
			ABT	ACT	LVT
Embedded Test-Bus Controllers with 8-Bit Generic Host Interfaces	3S	8980			✓
Test-Bus Controllers IEEE Std 1149.1 (JTAG) TAP Masters with 16-Bit Generic Host Interfaces	3S	8990		✓	
10-Bit Addressable Scan Ports Multidrop-Addressable IEEE Std 1149.1 (JTAG) TAP Transceivers		8996	✓		✓
10-Bit Linking Addressable IEEE Std 1149.1 (JTAG) TAP Transceivers	3S	8986			✓
Scan-Path Linkers with 4-Bit Identification Buses Scan-Controlled IEEE Std 1149.1 (JTAG) TAP Concatenators	3S	8997		✓	

**BUFFERS AND DRIVERS**

**Inverting Buffers and Drivers**

DESCRIPTION	OUTPUT	TYPE	TECHNOLOGY																							
			ABT	AC	ACT	AHC	AHCT	ALS	ALVC	ALVT	AS	AUC	BCT	64BCT	CD4K	F	FCT	GTLP	HC	HCT	LS	LV	LVC	LVT	S	TTL
Single	OD	1G06										✓											✓			
	3S	1G240										✓											✓			
Dual	3S	2G06										✓											✓			
		2G240										+											✓			
Triple	OD	3G06										+											✓			

## BUFFERS AND DRIVERS

## Inverting Buffers and Drivers (continued)

DESCRIPTION	OUTPUT	TYPE	TECHNOLOGY																								
			ABT	AC	ACT	AHC	AHCT	ALS	ALVC	ALVT	AS	AUC	BCT	64BCT	CD4K	F	FCT	GTLP	HC	HCT	LS	LV	LVC	LVT	S	TTL	
Hex	OC	06																			✓	✓				✓	
	OD	06																				✓	✓				
	OC	16																								✓	
	3S	366																		✓							
		368																		✓	✓	✓					✓
OC	1005							✓																			
Hex Buffers/Converters		4009												✓													
Hex Buffers/Converters		4049												✓				✓									
Hex Drivers		1004								✓																	
Hex Schmitt Triggers		40106												✓													
Strobed Hex Inverters/Buffers	3S	4502												✓													
Octal	3S	240	✓	✓	✓	✓	✓	✓			✓	✓	✓			✓			✓	✓	✓	✓	✓	✓	✓	✓	
		11240		✓	✓																						
		1244							✓																		
		540	✓	✓	✓	✓	✓	✓					✓				✓			✓	✓	✓	✓	✓	✓		
	OC	756									✓		✓														
Octal with Input Pullup Resistors	3S	746						✓																			
Octal Buffers and Line/MOS Drivers with Series Damping Resistors	3S	2240	✓					✓					✓					✓									
10 Bit	3S	828																						✓			
		29828						✓																			
11-Bit Line/Memory Drivers	3S	5401	✓																								
12-Bit Line/Memory Drivers	3S	5403	✓																								
16 Bit	3S	16240	✓		✓	✓	✓		✓	✓					+			✓					✓	✓			
		16540	✓			✓	✓																✓				



**Inverting Buffers and Drivers (continued)**

DESCRIPTION	OUTPUT	TYPE	TECHNOLOGY																						
			ABT	AC	ACT	AHC	AHCT	ALS	ALVC	ALVT	AS	AUC	BCT	64BCT	CD4K	F	FCT	GTLP	HC	HCT	LS	LV	LVC	LVT	S
16 Bit with Series Damping Resistors	3S	162240															✓							✓	
		162244																							✓
32-Bit	3S	32240																					✓	✓	
GTLP-to-LVTTL 1-to-6 Fanout Drivers	3S	817															✓								

**Noninverting Buffers and Drivers**

DESCRIPTION	OUTPUT	TYPE	TECHNOLOGY																									
			ABT	AC	ACT	AHC	AHCT	ALB	ALS	ALVC	ALVT	AS	AUC	AVC	BCT	64BCT	CD4K	F	FCT	HC	HCT	LS	LV	LVC	LVT	S	TTL	
Single Bus Buffers	OD	1G07											✓											✓				
		1G17											✓												✓			
	3S	1G125				✓	✓						✓												✓			
		1G126				✓	✓						✓													✓		
Dual		2G07										✓												✓				
Dual Bus Buffers	OD	2G17											+												✓			
		2G34												+												✓		
	3S	2G125												+												✓		
		2G126												+													✓	
		2G241												+													✓	
Triple Bus Buffers	OD	3G07												+												✓		
		3G17													+													✓
		3G34													+													✓
Quad Bus Buffers	3S	125	✓			✓	✓				✓						✓		✓	✓	✓	✓	✓	✓	✓			
		126	✓			✓	✓				✓						✓		✓	✓	✓	✓	✓	✓	✓	✓		
Hex Buffers	OC	1035								✓																		
	3S	4503															✓											
Hex Buffers/Converters		4010															✓											
		4050															✓		✓									

## BUFFERS AND DRIVERS

### Noninverting Buffers and Drivers (continued)

DESCRIPTION	OUTPUT	TYPE	TECHNOLOGY																										
			ABT	AC	ACT	AHC	AHCT	ALB	ALS	ALVC	ALVT	AS	AUC	AVC	BCT	64BCT	CD4K	F	FCT	HC	HCT	LS	LV	LVC	LVT	S	TTL		
Hex Buffers/ Line Drivers	3S	365																			✓	✓	✓						
		367				✓	✓															✓	✓	✓	✓				✓
	OC	07																					✓	✓					✓
		OD	07																						✓				
	OC	17																											✓
		35									✓																		
Hex Drivers		1034								✓			✓																
Hex OR Gate Line Drivers		128																										✓	
Octal	3S	241	✓	✓	✓					✓			✓						✓		✓	✓	✓				✓	✓	
		244	✓	✓	✓	✓	✓			✓	✓		✓	✓					✓	✓	✓	✓	✓	✓	✓	✓	✓	✓	
		1244									✓																		
	CP/3S	11244		✓	✓																								
	OC	541	✓	✓	✓	✓	✓				✓									✓	✓	✓	✓	✓	✓	✓	✓		
		757												✓								✓	✓	✓	✓	✓	✓	✓	
	760										✓			✓								✓	✓						
Octal with Series Damping Resistors	3S	2244	✓																✓	✓					✓				
		25244																								✓			
Octal Buffers	3S	465																					✓						
Octal Buffers and Line/MOS Drivers with Series Damping Resistors	3S	2241	✓																										
Octal Line Drivers/ MOS Drivers	3S	2541								✓										✓									
10 Bit	3S	827	✓																	✓						✓			
		29827									✓																		
10 Bit with Series Damping Resistors	3S	2827	✓																	✓									
11-Bit Line/Memory Drivers	3S	5400	✓																										

**Noninverting Buffers and Drivers (continued)**

DESCRIPTION	OUTPUT	TYPE	TECHNOLOGY																									
			ABT	AC	ACT	AHC	AHCT	ALB	ALS	ALVC	ALVT	AS	AUC	AVC	BCT	64BCT	CD4K	F	FCT	HC	HCT	LS	LV	LVC	LVT	S	TTL	
12-Bit Line/Memory Drivers	3S	5402	✓																									
16 Bit	3S	16241	✓																						✓			
		16244	✓	✓	✓	✓	✓	✓		✓	✓		✓	✓					✓						✓	✓		
		16541	✓		✓	✓	✓																		✓	✓		
16 Bit with Series Damping Resistors	3S	162244	✓							✓	✓								✓					✓	✓			
18 Bit	3S	16825	✓		✓					✓																		
18 Bit with Series Damping Resistors	3S	162825	✓																									
20 Bit	3S	16827	✓		✓					✓	✓			✓					✓									
20 Bit with Series Damping Resistors	3S	162827	✓							✓	✓																	
20 Bit with Balanced Drive and Series Damping Resistors	3S	162827																	✓									
1-Bit to 2-Bit Address Drivers	3S	162830								✓																		
1-Bit to 4-Bit Address Drivers	3S	16344								✓																		
		162344								✓																		
1-to-4 Address Registers/Drivers	3S	16831								✓																		
		16832								✓																		
32 Bit	3S	32244								✓	✓		✓	✓										✓	✓			
4-Segment Liquid Crystal Display Drivers		4054																✓										

## BUS SWITCHES

### Bus Exchange/Multiplexing Switches

DESCRIPTION	TYPE	TECHNOLOGY	
		CBT	CBTLV
1-of-8 FET Multiplexers/Demultiplexers	3251	✓	✓
Dual 1-of-4 FET Multiplexers/Demultiplexers	3253	✓	✓
4-Bit 1-of-2 FET Multiplexers/Demultiplexers	3257	✓	✓
10-Bit FET Bus-Exchange Switches	3383	✓	✓
12-Bit 1-of-2 FET Multiplexers/Demultiplexers with Internal Pulldown Resistors	16292	✓	✓
12-Bit 1-of-3 FET Multiplexers/Demultiplexers	16214	✓	
Synchronous 16-Bit 1-of-2 FET Multiplexers/Demultiplexers	16232	✓	
16-Bit 1-of-2 FET Multiplexers/Demultiplexers	16233	✓	
16-Bit to 32-Bit FET Multiplexer/Demultiplexer Bus Switches	16390	✓	
18-Bit FET Bus-Exchange Switches	16209	✓	
24-Bit FET Bus-Exchange Switches	16212	✓	✓
	16213	✓	
24-Bit FET Bus-Exchange Switches with Schottky Diode Clamping	16212	✓	
	16213	✓	

### Standard Bus Switches

DESCRIPTION	TYPE	TECHNOLOGY									
		AUC	CB3Q	CB3T	CBT	CBTLV	CD4K	HC	HCT	LV	LVC
Single FET Bus Switches	1G125				✓						
	1G384				✓						
Single FET Bus Switches with Level Shifting	1G125				✓						
	1G384				✓						
Dual FET Bus Switches	3306		✓	✓	✓						
Dual FET Bus Switches with Level Shifting	3306				✓						
Dual FET Bus Switches with Schottky Diode Clamping	3306				✓						
Quad Bilateral Switches	4016						✓	✓			
	4066						✓	✓	✓	✓	
Quad FET Bus Switches	3125			✓	✓	✓					
	3126				✓	✓					
Single Bilateral Analog Switches	1G66	✓									✓

**Standard Bus Switches (continued)**

DESCRIPTION	TYPE	TECHNOLOGY									
		AUC	CB3Q	CB3T	CBT	CBTLV	CD4K	HC	HCT	LV	LVC
4-Bit Analog Switches with Level Translation	4316							✓	✓		
Octal FET Bus Switches	3244				✓						
	3245				✓	✓					
	3345				✓						
10-Bit FET Bus Switches	3384				✓	✓					
	3861				✓	✓					
10-Bit FET Bus Switches with Internal Pulldown Resistors	3857					✓					
10-Bit FET Bus Switches with Level Shifting	3861				✓						
10-Bit FET Bus Switches with Precharged Outputs and Diode Clamping	6800				✓						
10-Bit FET Bus Switches with Precharged Outputs and Active Clamp Undershoot Protection	6800				✓						
10-Bit FET Bus Switches with Precharged Outputs for Live Insertion	6800				✓						
10-Bit FET Bus Switches with Schottky Diode Clamping	3384		✓		✓						
16-Bit FET Bus Switches	16244	✓			✓						
	16245				✓						
16-Bit FET Bus Switches with Active Clamp Undershoot Protection	16245				✓						
20-Bit FET Bus Switches	16210				✓	✓					
	16861				✓						
20-Bit FET Bus Switches with Active Clamp Undershoot Protection	16861				✓						
20-Bit FET Bus Switches with Level Shifting	16210				✓						
	16861				✓						
20-Bit FET Bus Switches with Precharged Outputs	16800					✓					
20-Bit FET Bus Switches with Series Damping Resistors	19861				+						
24-Bit FET Bus Switches	16211				✓	✓					
24-Bit FET Bus Switches with Bus Hold	16211				✓						
24-Bit FET Bus Switches with Level Shifting	16211				✓						
24-Bit FET Bus Switches with Schottky Diode Clamping	16211				✓						
32-Bit FET Bus Switches	34X245				✓						
32-Bit FET Bus Switches with Active Clamp Undershoot Protection	32245				✓						

## COUNTERS

### Binary Counters

DESCRIPTION	TYPE	TECHNOLOGY													
		AC	ACT	ALS	AS	CD4K	F	FCT	HC	HCT	LS	LV	S	TTL	
Divide by 12	92										✓				
4 Bit Ripple	93								✓	✓	✓				
	293										✓				
Dual 4 Bit	393								✓	✓	✓	✓		✓	
Dual 4 Bit Up	4520					✓			✓	✓					
Presettable 4 Bit Up/Down	4516					✓									
Presettable 4 Bit BCD Up/Down with Dual Clock and Reset	40193					✓									
Presettable Synchronous 4 Bit Up/Down	191			✓				✓	✓	✓	✓				
	193			✓					✓	✓	✓			✓	
Programmable 4 Bit with Asynchronous Clear	40161					✓									
Synchronous 4 Bit	569			✓											
Synchronous 4 Bit Up/Down	169			✓	✓		✓				✓				
	669										✓				
	697										✓				
Synchronous 4 Bit with Preset and Asynchronous Clear	161	✓	✓	✓	✓		✓		✓	✓	✓	✓			
Synchronous 4 Bit with Preset and Synchronous Clear	163	✓	✓	✓	✓		✓	✓	✓	✓	✓	✓	✓		
8-Bit Counters/Dividers with 1-of-8 Decoded Outputs	4022					✓									
8 Bit with 3-State Output Registers	590								✓		✓				
8 Bit with Input Registers	592										✓				
8 Bit with Input Registers and Parallel Counter Outputs	593										✓				
8 Bit Synchronous Up/Down	867			✓	✓										
	869			✓	✓										
8 Bit Presettable Synchronous Down	40103					✓			✓	✓					
7-Stage Ripple-Carry Counters/Dividers	4024					✓			✓	✓					
12-Stage Ripple-Carry Counters/Dividers	4040					✓			✓	✓		✓			
14-Stage Ripple-Carry Counters/Dividers with Oscillators	4020					✓			✓	✓					
	4060					✓			✓	✓					
21 Stage	4045					✓									
Divide by N	4018					✓									
Programmable Divide by N	4059					✓			✓						
Presettable Up/Down or BCD Decade	4029					✓									

## Decade Counters

DESCRIPTION	TYPE	TECHNOLOGY			
		CD4K	HC	HCT	LS
Divide by 2, Divide by 5	90				✓
Dual Divide by 2, Divide by 5	390		✓	✓	✓
Synchronous Presettable BCD Up/Down	190		✓		
	192		✓		
Counters/Dividers with 1-of-10 Decoded Outputs	4017	✓	✓		
Counters/Drivers with Decoded 7-Segment Display Outputs	4026	✓			
	4033	✓			
BCD-to-Decimal Decoders	4028	✓			
Presettable BCD Up/Down	4510	✓			
Dual BCD Up	4518	✓	✓		
Programmable BCD Divide by N	4522	✓			
2 Decade Synchronous Presettable BCD Down	40102	✓			
Up-Down Counters/Latches/7-Segment Display Drivers	40110	✓			
Presettable BCD-Type Up/Down with Dual Clock and Reset	40192	✓			

## DECODERS, ENCODERS, AND MULTIPLEXERS

### Decoders

DESCRIPTION	OUTPUT	TYPE	TECHNOLOGY																	
			AC	ACT	AHC	AHCT	ALS	AS	AUC	BCT	CD4K	F	FCT	HC	HCT	LS	LV	LVC	S	TTL
1-of-2 Noninverting Demultiplexers	3S	1G18								+								✓		
Dual 2-to-4 Line Decoders/Demultiplexers		139	✓	✓	✓	✓	✓							✓	✓	✓	✓	✓	✓	
	CP	11139		✓																
		155														✓				
	OC	156					✓									✓				
Dual 2-Line to 4-Line Memory Decoders with On-Chip Supply-Voltage Monitors		2414									✓									
Dual Binary 1-of-4 Decoders/Demultiplexers		4555										✓								
		4556										✓								
3-to-8 Line Decoders/Demultiplexers		238	✓	✓										✓	✓					
3-to-8 Line Inverting Decoders/Demultiplexers		138	✓	✓	✓	✓	✓	✓					✓	✓	✓	✓	✓	✓	✓	✓
	CP	11138	✓																	
3-to-8 Line Decoders/Demultiplexers with Address Latches		137					✓							✓	✓					
		237												✓	✓					
BCD to 10 Line Decimal		42												✓	✓	✓				
4-Bit Latch/4 to 16 Line		4514										✓		✓	✓					
		4515										✓		✓	✓					
4-to-16 Line Decoders/Demultiplexers		154												✓	✓					✓
	OC	159																		✓
BCD-to-Decimal Decoders/Drivers	OC	45																		✓
		145															✓			✓
BCD to 7-Segment Decoders/Drivers	OC	47															✓			✓
		247															✓			✓
BCD to 7-Segment Latches/Decoders/Drivers		4511										✓		✓	✓					
BCD to 7-Segment LCD Decoders/Drivers with Display-Frequency Outputs		4055										✓								
BCD to 7-Segment LCD Decoders/Drivers with Strobed Latch Function		4056										✓								
BCD to 7-Segment Latches/Decoders/Drivers for LCDs		4543										✓		✓	✓					



## Multiplexers

DESCRIPTION	OUTPUT	TYPE	TECHNOLOGY																		
			ABT	AC	ACT	AHC	AHCT	ALS	AS	AUC	CD4K	F	FCT	HC	HCT	LS	LV	LVC	PCA	S	TTL
Single 2-to-1 Line Data Selectors/Multiplexers		2G157									+							✓			
1-of-8 Analog Multiplexers/Demultiplexers		4051															✓				
1-of-8 Analog Multiplexers/Demultiplexers with Logic Level Conversion		4051										✓			✓	✓					
1-of-8 Analog Multiplexers/Demultiplexers with Latches		4351													✓	✓					
1-of-8 Data Selectors	3S	4512										✓									
1-of-8 Data Selectors/Multiplexers		151		✓	✓				✓	✓					✓	✓	✓				✓
	3S	251		✓					✓						✓	✓	✓				
1-of-8 Data Selectors/Multiplexers/Registers	3S	354													✓	✓					
		356														✓					
1-of-8 Differential Analog Multiplexers/Demultiplexers		4097										✓									
1-of-16 Analog Multiplexers/Demultiplexers		4067										✓			✓	✓					
1-of-16 Data Selectors/Multiplexers		150																			✓
1-of-16 Data Generators/Multiplexers	3S	250								✓											
Dual 1-of-4 Data Selectors/Multiplexers		153		✓	✓				✓	✓					✓	✓	✓				
	3S	253		✓	✓				✓	✓					✓	✓	✓				
Dual Analog Multiplexers/Demultiplexers		2G53									+								✓		
Dual 1-of-4 Analog Multiplexers/Demultiplexers		4052																✓			
Dual 1-of-4 Analog Multiplexers/Demultiplexers with Logic Level Conversion		4052										✓			✓	✓					
Dual 1-of-4 Analog Multiplexers/Demultiplexers with Latches		4352													✓						
Triple 1-of-2 Analog Multiplexers/Demultiplexers		4053																	✓		
Triple 1-of-2 Analog Multiplexers/Demultiplexers with Logic Level Conversion		4053										✓			✓	✓					
Quad 1-of-2 Data Selectors/Multiplexers	3S	257		✓	✓				✓	✓				✓	✓	✓			✓		✓
		258			✓				✓	✓					✓	✓	✓				✓
	CP/3S	11257		✓	✓																
Quad 1-of-2 Data Selectors/Multiplexers with Series Damping Resistors	3S	2257													✓						
Quad 2-to-1 Data Selectors/Multiplexers		157		✓	✓	✓	✓	✓	✓					✓	✓	✓	✓	✓			✓
	3S	40257										✓									

## DECODERS, ENCODERS, AND MULTIPLEXERS

### Multiplexers (continued)

DESCRIPTION	OUTPUT	TYPE	TECHNOLOGY																			
			ABT	AC	ACT	AHC	AHCT	ALS	AS	AUC	CD4K	F	FCT	HC	HCT	LS	LV	LVC	PCA	S	TTL	
Quad 2-to-1 Data Selectors/Multiplexers with Storage		298							✓						✓							
		399										✓			✓							
Quad 2-to-4 Data Selectors/Multiplexers		158		✓	✓	✓	✓	✓	✓					✓	✓	✓					✓	
Hex 2-to-1 Universal Multiplexers	3S	857						✓														
4-to-1 Multiplexers/Demultiplexers	3S	16460	✓																			
Nonvolatile 5-Bit Registers with I <sup>2</sup> C Interface		8550																			✓	

### Priority Encoders

DESCRIPTION	OUTPUT	TYPE	TECHNOLOGY			
			CD4K	HC	HCT	LS
8 to 3 Line		148		✓		✓
	3S	348				✓
		4532	✓			
10 to 4 Line		147		✓	✓	
10 to 4 Line BCD		40147	✓			

## FIFOs (FIRST-IN, FIRST-OUT MEMORIES)

### Asynchronous FIFO Memories

DESCRIPTION	OUTPUT	TYPE	TECHNOLOGY							
			ABT	ACT	ALS	ALVC	CD4K	HC	HCT	S
16 × 4	3S	232			✓					
		40105					✓	✓	✓	
16 × 5	3S	225								✓
		229			✓					
		233			✓					
64 × 4	3S	236			✓					
64 × 18	3S	7814		✓						
64 × 18 3.3 V	3S	7814				✓				
256 × 18	3S	7806		✓						
256 × 18 3.3 V	3S	7806				✓				
512 × 18	3S	7804		✓						
512 × 18 3.3 V	3S	7804				✓				
512 × 18 × 2 Bidirectional	3S	7820	✓							
1024 × 9 × 2 Bidirectional	3S	2235		✓						
1024 × 18	3S	7802		✓						
2048 × 9	3S	7808		✓						

**FIFOS (FIRST-IN, FIRST-OUT MEMORIES)****Synchronous FIFO Memories**

DESCRIPTION	OUTPUT	TYPE	TECHNOLOGY				
			ABT	ACT	ALVC	LS	V
16 × 4	3S	224				✓	
64 × 1 × 2 Independent	3S	2226		✓			
		2227		✓			
64 × 18	3S	7813		✓			
64 × 18 3.3 V	3S	7813			✓		
64 × 36	3S	3611	✓				
		3613	✓				
64 × 36 × 2 Bidirectional	3S	3612	✓				
		3614	✓				
256 × 1 × 2 Independent	3S	2228		✓			
		2229		✓			
256 × 18	3S	7805		✓			
256 × 18 3.3 V	3S	7805			✓		
256 × 36 × 2 Bidirectional	3S	3622		✓			
512 × 18	3S	7803		✓			
512 × 18 3.3 V	3S	215					✓
		7803			✓		
512 × 18 × 2 Bidirectional	3S	7819	✓				
512 × 36	3S	3631		✓			
512 × 36 3.3 V	3S	3631			✓		
512 × 36 × 2 Bidirectional	3S	3632		✓			
		3638		✓			
1024 × 18	3S	7811		✓			
		7881		✓			
1024 × 18 3.3 V	3S	225					✓
1024 × 36	3S	3641		✓			
1024 × 36 3.3 V	3S	3640					✓
		3641			✓		
2048 × 9	3S	7807		✓			
2048 × 18	3S	7882		✓			
2048 × 18 3.3 V	3S	235					✓

**Synchronous FIFO Memories (continued)**

DESCRIPTION	OUTPUT	TYPE	TECHNOLOGY				
			ABT	ACT	ALVC	LS	V
2048 × 36	3S	3651		✓			
2048 × 36 3.3 V	3S	3650					✓
		3651			✓		
4096 × 18 3.3 V	3S	245					✓
4096 × 36 3.3 V	3S	3660					✓
8192 × 18 3.3 V	3S	263					✓
8192 × 36 3.3 V	3S	3670					✓
16384 × 9 3.3 V	3S	263					✓
16384 × 18 3.3 V	3S	273					✓
16384 × 36 3.3 V	3S	3680					✓
32768 × 9 3.3 V	3S	273					✓
32768 × 18 3.3 V	3S	283					✓
32768 × 36 3.3 V	3S	3690					✓
65536 × 9 3.3 V	3S	283					✓
65536 × 18 3.3 V	3S	293					✓
131072 × 9 3.3 V	3S	293					✓

**FLIP-FLOPS**

**D-Type Flip-Flops (3-state)**

DESCRIPTION	OUTPUT	TYPE	TECHNOLOGY																						
			ABT	AC	ACT	AHC	AHCT	ALS	ALVC	ALVT	AS	AUC	AVC	BCT	F	FCT	HC	HCT	LS	LV	LVC	LVT	S		
Dual 4 Bit Edge Triggered	3S	874							✓			✓													
		876							✓			✓													
Quad	3S	173															✓	✓	✓						
Octal Bus Interface	3S	825									✓					✓									
		29825														✓									
Octal Edge Triggered	3S	374	✓	✓	✓	✓	✓	✓	✓		✓			✓	✓	✓	✓	✓	✓	✓	✓	✓	✓	✓	
	3S/CP	11374			✓																				
	3S	574	✓	✓	✓	✓	✓	✓	✓			✓			✓	✓	✓	✓	✓			✓	✓	✓	
		575										✓													
		576										✓													
577											✓														

### FLIP-FLOPS

#### D-Type Flip-Flops (3-state) (continued)

DESCRIPTION	OUTPUT	TYPE	TECHNOLOGY																					
			ABT	AC	ACT	AHC	AHCT	ALS	ALVC	ALVT	AS	AUC	AVC	BCT	F	FCT	HC	HCT	LS	LV	LVC	LVT	S	
Octal Edge Triggered Dual Rank	3S	4374										✓												
Octal Edge Triggered with Series Damping Resistors	3S	2374														✓								
		2574														✓								
Octal Inverting	3S	534	✓	✓	✓				✓								✓	✓						
		564		✓	✓				✓								✓	✓	✓					
9 Bit Bus Interface	3S	823	✓									✓				✓							✓	
		29823							✓															
10 Bit Bus Interface	3S	821	✓									✓											✓	
		29821							✓						✓									
10 Bit with Dual Outputs	3S	16820									✓													
		162820									✓													
16 Bit Edge Triggered	3S	16374	✓	✓	✓	✓	✓			✓	✓		✓	✓		✓						✓	✓	
		162374									✓						+							✓
		163374																						✓
18 Bit	3S	16823	✓		✓					✓							+							
		162823	✓															+						
20 Bit	3S	16721								✓														
		162721								✓														
		16722																✓						
		16821	✓								✓	✓						+						
32 Bit Edge Triggered	3S	32374								✓	✓						✓					✓	✓	
		322374																						✓

**D-Type Flip-Flops (non 3-state)**

DESCRIPTION	OUTPUT	TYPE	TECHNOLOGY																			
			ABT	AC	ACT	AHC	AHCT	ALS	AS	AUC	CD4K	F	FCT	HC	HCT	LS	LV	LVC	LVT	S	TTL	
Single Edge Triggered		1G79								✓								✓				
		1G80								✓								✓				
Single Edge Triggered with Preset and Clear		2G74								+												
Dual		4013									✓											
		74		✓•	✓•	✓	✓	✓	✓			✓		✓	✓	✓	✓	✓		✓		
	CP	11074		✓	✓																	
Dual Edge Triggered		2G79								+												
		2G80								+												
Quad	CP	175		✓•	✓				✓	✓			✓		✓	✓	✓	✓		✓	✓	
		11175		✓																		
		40175										✓										
Hex		174		✓	✓	✓	✓	✓	✓			✓		✓	✓	✓	✓			✓		
		40174										✓										
Hex with Enable		378															✓					
Octal		273	✓	✓	✓	✓	✓	✓					✓	✓	✓	✓	✓		✓			
Octal with Enable		377	✓										✓	✓	✓	✓	✓					

**Other Flip-Flops**

DESCRIPTION	TYPE	TECHNOLOGY																			
		AC	ACT	ALS	AS	CD4K	F	HC	HCT	LS	LVC	S	TTL								
Dual Edge-Triggered J-K Master-Slave	4027					✓															
Dual Edge-Triggered J-K with Reset	73											✓	✓	✓							
	107											✓	✓	✓							✓
Dual Edge-Triggered J-K with Set and Reset	112	✓	✓	✓						✓	✓	✓	✓	✓	✓		✓				
Dual Positive-Edge-Triggered J-K with Set and Reset	109	✓	✓	✓	✓					✓	✓	✓	✓	✓							
Quad Edge-Triggered J-K	276																				✓





**NAND Gates (continued)**

DESCRIPTION	OUTPUT	TYPE	TECHNOLOGY																	
			AC	ACT	AHC	AHCT	ALS	ALVC	AS	AUC	CD4K	F	HC	HCT	LS	LV	LVC	S	TTL	
Quad 2 Input		00	✓•	✓•	✓	✓	✓	✓	✓			✓	✓	✓	✓	✓	✓	✓	✓	
	CP	11000	✓	✓																
	OC	03					✓							✓						
	OD	03											✓	✓						
		4011									✓									
	3S	26													✓					
		37					✓								✓			✓	✓	
	OC	38					✓					✓			✓			✓	✓	
Quad 2-Input Buffers/Drivers		1000							✓											
Quad 2 Input Unbuffered		4011									✓									
Quad 2 Input with Schmitt-Trigger Inputs		132			✓	✓							✓	✓	✓	✓		✓	✓	
		4093									✓									
Hex 2-Input Drivers		804					✓		✓											
		1804							✓											
Triple 3 Input		10	✓	✓			✓	✓	✓			✓	✓	✓	✓	✓	✓	✓	✓	
		4023									✓									
Dual 4 Input		4012									✓									
		20	✓	✓			✓		✓			✓	✓	✓	✓	✓		✓		
Dual 4-Input Positive 50-Ω Line Drivers		140																✓		
8 Input		30		•			✓		✓			✓	✓	✓	✓					
	CP	11030		✓																
8 Input AND/NAND		4068									✓									
13 Input		133					✓											✓		

## GATES AND INVERTERS

### AND-OR-Invert Gates

DESCRIPTION	TYPE	TECHNOLOGY		
		CD4K	LS	S
Dual 2 Wide 2 Input	51			✓
	4085	✓		
Dual 2 Wide 2 Input, 2 Wide 3 Input	51		✓	
Expandable 4 Wide 2 Input	4086	✓		
Expandable 8 Input	4048	✓		

### OR Gates

DESCRIPTION	OUTPUT	TYPE	TECHNOLOGY																	
			AC	ACT	AHC	AHCT	ALS	ALVC	AS	AUC	CD4K	F	HC	HCT	LS	LV	LVC	S	TTL	
Single 2 Input		1G32			✓	✓					✓							✓		
Dual 2 Input		2G32									+							✓		
Quad 2 Input		32	✓	✓	✓	✓	✓	✓	✓				✓	✓	✓	✓	✓	✓	✓	✓
	CP	11032	✓	✓																
		4071										✓								
Quad 2-Input Buffers/Drivers		1032								✓										
Quad 2 Input with Schmitt-Trigger Inputs		7032												✓						
Hex 2-Input Drivers		832					✓		✓											
Dual 4 Input		4072										✓								
Triple 3 Input		4075										✓		✓	✓					

**NOR Gates**

DESCRIPTION	OUTPUT	TYPE	TECHNOLOGY																
			AC	ACT	AHC	AHCT	ALS	AS	AUC	CD4K	F	HC	HCT	LS	LV	LVC	S	TTL	
Single 2 Input		1G02			✓	✓				✓							✓		
Dual 2 Input		2G02								✓							✓		
Quad 2 Input		4001									✓								
		02	✓	✓	✓	✓	✓	✓			✓	✓	✓	✓	✓	✓	✓	✓	
		OC 33						✓						✓					
Quad 2 Input with Schmitt-Trigger Inputs		7002										✓							
Quad 2 Input Unbuffered		4001									✓								
Hex 2-Input Drivers		805					✓	✓											
		808						✓											
Triple 3 Input		4025									✓								
		27					✓	✓			✓	✓	✓	✓	✓				
Dual 4 Input		4002									✓		✓						
Dual 4 Input with Strobe		25																	✓
Dual 5 Input		260										✓							
8 Input NOR/OR		4078									✓								

**Exclusive-OR Gates**

DESCRIPTION	OUTPUT	TYPE	TECHNOLOGY																	
			AC	ACT	AHC	AHCT	ALS	AS	AUC	CD4K	F	HC	HCT	LS	LV	LVC	S			
Single 2 Input		1G86			✓	✓				✓								✓		
Dual 2 Input		2G86								+									+	
Quad 2 Input		4030									✓									
		4070									✓									
		86	✓	✓	✓	✓	✓	✓			✓	✓	✓	✓	✓	✓	✓	✓	✓	
		CP 11086	✓																	
		OC 136													✓					

## GATES AND INVERTERS

### Exclusive-NOR Gates

DESCRIPTION	OUTPUT	TYPE	TECHNOLOGY		
			CD4K	HC	LS
Quad 2 Input	OC	266			✓
	OD	266		✓	
		4077	✓		
		7266		✓	

### Gate and Delay Elements

DESCRIPTION	TYPE	TECHNOLOGY	
		CD4K	LS
Dual Unbuffered Complementary Pairs Plus Inverters	4007	✓	
Quad AND/OR Select Gates	4019	✓	
Quad True/Complement Buffers	4041	✓	
Hex Delay Elements for Generating Delay Lines	31		✓
Hex Gates (4 Inverters, 2-Input NOR, 2-Input NAND)	4572	✓	

**Inverters**

DESCRIPTION	OUTPUT	TYPE	TECHNOLOGY																
			AC	ACT	AHC	AHCT	ALS	ALVC	AS	AUC	CD4K	F	HC	HCT	LS	LV	LVC	S	TTL
Single		1G04			✓	✓				✓							✓		
Unbuffered Single		1GU04			✓					✓							✓		
Single Schmitt Trigger		1G14			✓	✓				✓							✓		
Dual		2G04								✓									
		2GU04								✓									
Dual Schmitt Trigger		2G14								+							✓		
Triple		3G04								+							✓		
Unbuffered Triple		3GU04								+							+		
Triple Schmitt Trigger		3G14								+							✓		
Hex		04	✓	✓	✓	✓	✓	✓	✓			✓	✓	✓	✓	✓	✓	✓	✓
	CP	11004	✓	✓															
	OC	05					✓							✓			✓		
	OD	05	✓	✓	✓								✓		✓				
		4069										✓							
Unbuffered Hex		U04			✓							✓				✓	✓		
Hex Schmitt Trigger		14	✓	✓	✓	✓		✓				✓	✓	✓	✓	✓			✓
		19												✓					

## LATCHES

## D-Type Latches (3-state)

DESCRIPTION	TYPE	TECHNOLOGY																					
		ABT	AC	ACT	AHC	AHCT	ALS	ALVC	ALVT	AS	AUC	AVC	BCT	F	FCT	HC	HCT	LS	LV	LVC	LVT	S	
Dual 4 Bit	873						✓			✓													
Octal Inverting Transparent	533	✓	✓	✓			✓			✓						✓	✓						
	563		✓	✓			✓									✓	✓						
Octal Transparent	373	✓	✓	✓	✓	✓	✓	✓		✓			✓	✓		✓	✓	✓	✓		✓	✓	
	11373			✓																			
	573	✓	✓	✓	✓	✓	✓			✓			✓	✓	✓	✓	✓		✓	✓	✓	✓	
	580						✓																
	845						✓																
Octal Transparent Read Back	666						✓																
	667						✓																
Octal Transparent with Series Damping Resistors	2373													✓	✓								
	2573														✓	✓							
9 Bit Transparent	843	✓					✓																
	29843												✓										
9 Bit Transparent Read Back	992						✓																
10 Bit Transparent	841	✓					✓			✓						✓					✓		
12 Bit to 24 Bit Multiplexed	16260	✓						✓															
12 Bit to 24 Bit Multiplexed with Series Damping Resistors	162260	✓						✓															
16 Bit Transparent	16373	✓	✓	✓	✓	✓		✓	✓		✓	✓			✓						✓	✓	
	162373														✓							✓	
18 Bit Transparent	16843	✓																					
20 Bit Transparent	16841	✓		✓				✓							✓								
	162841	✓						✓							✓								
32 Bit Transparent	32373							✓				✓									✓	✓	

**Other Latches**

DESCRIPTION	OUTPUT	TYPE	TECHNOLOGY				
			ALS	CD4K	HC	HCT	LS
Dual 2 Bit Bistable Transparent		75			✓	✓	
Dual 4 Bit with Strobe	3S	4508		✓			
4 Bit Bistable		75					✓
		375					✓
Quad Clocked D		4042		✓			
Quad NAND R-S	3S	4044		✓			
Quad NOR R-S	3S	4043		✓			
Quad $\bar{S}\text{-}\bar{R}$		279					✓
8 Bit Addressable		259	✓		✓	✓	✓
		4099		✓			
		4724		✓			
8 Bit D-Type Transparent Read Back		990	✓				
8 Bit Edge Triggered Read Back		996	✓				
10 Bit D-Type Transparent Read Back		994	✓				

**LITTLE LOGIC**

**AND Gates**

DESCRIPTION	TYPE	TECHNOLOGY			
		AHC	AHCT	AUC	LVC
Single 2 Input	1G08	✓	✓	✓	✓
Dual 2 Input	2G08			+	✓

## LITTLE LOGIC

**NAND Gates**

DESCRIPTION	TYPE	TECHNOLOGY			
		AHC	AHCT	AUC	LVC
Single	1G10			+	+
	1G11			+	+
	1G27			+	+
	1G332			+	+
	1G386			+	✓
Single-Pole Double-Throw Analog Switches	1G3157				✓
Single 2-1	2G257			+	
Single 2 Input	1G00	✓	✓	✓	✓
Dual 2 Input	2G00			✓	✓

**OR Gates**

DESCRIPTION	TYPE	TECHNOLOGY			
		AHC	AHCT	AUC	LVC
Single 2 Input	1G32	✓	✓	✓	✓
Dual 2 Input	2G32			+	✓

**NOR Gates**

DESCRIPTION	TYPE	TECHNOLOGY			
		AHC	AHCT	AUC	LVC
Single 2 Input	1G02	✓	✓	✓	✓
Dual 2 Input	2G02			✓	✓

**Exclusive-OR Gates**

DESCRIPTION	TYPE	TECHNOLOGY			
		AHC	AHCT	AUC	LVC
Single 2 Input	1G86	✓	✓	✓	✓
Dual 2 Input	2G86			+	✓



### D-Type Flip-Flops

DESCRIPTION	TYPE	TECHNOLOGY	
		AUC	LVC
Single Edge Triggered	1G79	✓	✓
	1G80	✓	✓
Single Edge Triggered with Preset and Clear	2G74	+	✓
Dual Edge Triggered	2G79	+	
	2G80	+	

### Decoders

DESCRIPTION	OUTPUT	TYPE	TECHNOLOGY	
			AUC	LVC
1-of-2 Decoders/Demultiplexers		1G19	+	
1-of-2 Noninverting Demultiplexers	3S	1G18	+	✓

### Inverters

DESCRIPTION	TYPE	TECHNOLOGY			
		AHC	AHCT	AUC	LVC
Single	1G04	✓	✓	✓	✓
	1GU04	✓		✓	✓
Single Schmitt Trigger	1G14	✓	✓	✓	✓
Dual	2G04			✓	✓
	2GU04			✓	✓
Dual Schmitt Trigger	2G14			+	✓
Triple Schmitt Trigger	3G04			+	✓
	3G14			+	✓
Unbuffered Triple	3GU04			+	+

## LITTLE LOGIC

**Inverting Buffers and Drivers**

DESCRIPTION	OUTPUT	TYPE	TECHNOLOGY	
			AUC	LVC
Single	OD	1G06	✓	✓
	3S	1G240	✓	✓
Dual	3S	2G06	✓	✓
		2G240	+	✓
Triple	OD	3G06	+	✓

**Noninverting Buffers and Drivers**

DESCRIPTION	OUTPUT	TYPE	TECHNOLOGY			
			AHC	AHCT	AUC	LVC
Single	OD	1G07			✓	✓
Single Bus Buffers	3S	1G125	✓	✓	✓	✓
		1G126	✓	✓	✓	✓
Single Schmitt Trigger		1G17			✓	✓
Dual		2G07			✓	✓
		2G34			+	✓
Dual Bus Buffers	OD	2G17			+	✓
		2G125			+	✓
	3S	2G126			+	✓
		2G241			+	✓
Triple	OD	3G07			+	✓
		3G17			+	
		3G34			+	✓

**Multiplexers**

DESCRIPTION	TYPE	TECHNOLOGY	
		AUC	LVC
Single 2- to 1-Line Data Selectors/Multiplexers	2G157	+	✓
Dual Analog Multiplexers/Demultiplexers	2G53	+	✓

### Specialty Logic

DESCRIPTION	TYPE	TECHNOLOGY	
		AUC	LVC
Configurable Multiple-Function Gates	1G57	+	✓
	1G58	+	✓
	1G97	+	✓
	1G98	+	✓

### Standard Bus Switches

DESCRIPTION	TYPE	TECHNOLOGY			
		AUC	CBT	CBTLV	LVC
Single Bilateral (Analog or Digital)	1G66	✓			✓
Single FET	1G125		✓	✓	
	1G384		✓		
Single FET with Level Shifting	1G125		✓		
	1G384		✓		
Dual Bilateral (Analog or Digital)	2G66	+			✓

## MEMORY DRIVERS AND TRANSCIEVERS (HSTL, SSTL, SSTU, AND SSTV/SSTVF)

### Buffers, Drivers, and Latches

DESCRIPTION	OUTPUT	TYPE	TECHNOLOGY				
			HSTL	SSTL	SSTU	SSTV	SSTVF
9-Bit to 18-Bit HSTL-to-LVTTL Memory Address Latches		16918	✓				
9-Bit to 18-Bit HSTL-to-LVTTL Memory Address Latches with Pullup Resistors		16919	✓				
13-Bit to 26-Bit Registered Buffers with SSTL_2 Inputs and Outputs		16859				✓	✓
14-Bit Registered Buffers with SSTL_2 Inputs and Outputs		16857		✓		✓	✓
14-Bit to 28-Bit HSTL-to-LVTTL Memory Address Latches		162822	✓				
20-Bit SSTL_3 Interface Buffers	3S	16847		✓			
20-Bit SSTL_3 Interface Universal Bus Drivers	3S	16837		✓			
24-Bit to 48-Bit Registered Buffers with SSTL_2 Inputs and Outputs		32852				✓	✓
25-Bit Configurable Registered Buffers with Address-Parity Test		32866			+		
25-Bit Configurable Registered Buffers with SSTL_18 Inputs and Outputs		32864			✓		
26-Bit Registered Buffers with SSTL_2 Inputs and Outputs		32877				✓	
26-Bit Registered Buffers with SSTL_2 Inputs and LVCMOS Outputs		32867				✓	



**Registers (continued)**

DESCRIPTION	OUTPUT	TYPE	TECHNOLOGY													
			AC	ACT	AHC	AHCT	ALS	ALVC	AS	CD4K	F	FCT	HC	HCT	LS	LV
64 Stage Static Shift		4031									✓					
Dual 64 Stage Static Shift	3S	4517									✓					

**SPECIALTY LOGIC**

**Adders**

DESCRIPTION	TYPE	TECHNOLOGY						
		AC	ACT	F	HC	HCT	LS	S
9 Bit Binary Full with Fast Carry	283	✓	✓	✓	✓	✓	✓	✓

**Arithmetic Logic Units**

DESCRIPTION	TYPE	TECHNOLOGY		
		AS	LS	S
Arithmetic Logic Units/Function Generators	181	✓	✓	
	381			✓
Look-Ahead Carry Generators	182			✓

**Bus-Termination Arrays and Networks**

DESCRIPTION	TYPE	TECHNOLOGY			
		ACT	CD4K	F	S
Dual 4-Bit Programmable Terminators	40117		✓		
8-Bit Schottky Barrier Diode Bus-Termination Arrays	1056			✓	
10-Bit Bus-Termination Networks with Bus Hold	1071	✓			
12-Bit Schottky Barrier Diode Bus-Termination Arrays	1050				✓
	1051				✓
16-Bit Bus-Termination Networks with Bus Hold	1073	✓			
16-Bit Schottky Barrier Diode Bus-Termination Arrays	1052				✓
	1053				✓
16-Bit Schottky Barrier Diode R-C Bus-Termination Arrays	1016			✓	

## SPECIALTY LOGIC

### Comparators (identity)

DESCRIPTION	OUTPUT	TYPE	TECHNOLOGY	
			ALS	F
8 Bit Identity ( $\overline{P} = \overline{Q}$ )		521	✓	✓
8 Bit Identity ( $P = Q$ ) with Input Pullup Resistors	OC	518	✓	
8 Bit Identity ( $\overline{P} = Q$ ) with Input Pullup Resistors		520	✓	✓
12 Bit Address		679	✓	

### Comparators (magnitude)

DESCRIPTION	TYPE	TECHNOLOGY						
		ALS	AS	CD4K	HC	HCT	LS	S
4 Bit	85				✓	✓	✓	✓
	4063			✓				
	4585			✓				
8 Bit	682				✓		✓	
	684				✓		✓	
	688	✓			✓	✓	✓	
	885		✓					

### Digital Phase-Locked Loops (PLLs)

DESCRIPTION	TYPE	TECHNOLOGY				
		ACT	CD4K	HC	HCT	LS
Digital PLLs	297	✓		✓	✓	✓
PLLs with VCO	4046		✓	✓	✓	
PLLs with VCO and Lock Detectors	7046			✓	✓	

### Drivers/Multipliers

DESCRIPTION	TYPE	TECHNOLOGY	
		CD4K	TTL
4-Bit Binary Rate Multipliers	4089	✓	
BCD Rate Multipliers	4527	✓	
Synchronous 6-Bit Binary Rate Multipliers	97		✓

### ECL/TTL Functions

DESCRIPTION	OUTPUT	TYPE	TECHNOLOGY
			ECL
Octal ECL-to-TTL Translators	3S	10KHT5541	✓
Octal ECL-to-TTL Translators with Edge-Triggered D-Type Flip-Flops	3S	10KHT5574	✓
Octal TTL-to-ECL Translators with Edge-Triggered D-Type Flip-Flops and Output Enable		10KHT5578	✓
Octal TTL-to-ECL Translators with Output Enable		10KHT5542	✓
		10KHT5543	✓

### Frequency Dividers/Timers

DESCRIPTION	TYPE	TECHNOLOGY	
		CD4K	LS
24-Stage Frequency Dividers	4521	✓	
Programmable Frequency Dividers/Digital Timers	292		✓
	294		✓
Programmable Timers	4536	✓	
	4541	✓	

### I<sup>2</sup>C Functions

DESCRIPTION	TYPE	TECHNOLOGY	
		PCA	PCF
Nonvolatile 5-Bit Resistors	8550	✓	
Remote 8-Bit I/O Expanders	8574		✓
	8574A		✓

### Little Logic

DESCRIPTION	TYPE	TECHNOLOGY	
		AUC	LVC
Configurable Multiple-Function Gates	1G57	+	✓
	1G58	+	✓
	1G97	+	✓
	1G98	+	✓

## SPECIALTY LOGIC

### Monostable Multivibrators

DESCRIPTION	TYPE	TECHNOLOGY							
		AHC	AHCT	CD4K	HC	HCT	LS	LV	TTL
Low Power Monostable/Astable	4047			✓					
Monostable Multivibrators with Schmitt-Trigger Inputs	121								✓
Retriggerable	122						✓		
Dual	4098			✓					
Dual with Schmitt-Trigger Inputs	221				✓	✓	✓	✓	✓
Dual Precision	14538			✓					
Dual Retriggerable with Reset	123	✓	✓		✓	✓	✓	✓	✓
	423				✓	✓	✓		
Dual Retriggerable Precision	4538				✓	✓			

### Oscillators

DESCRIPTION	TYPE	TECHNOLOGY	
		LS	S
Single Crystal Controlled	321	✓	
Single Voltage Controlled	624	✓	
	628	✓	
Dual Voltage Controlled	124		✓
	629	✓	

### Parity Generators and Checkers

DESCRIPTION	OUTPUT	TYPE	TECHNOLOGY										
			AC	ACT	ALS	AS	F	FCT	HC	HCT	LS	S	
Dual 8 Bit Odd		480						✓					
9 Bit Odd/Even		280	✓	✓	✓	✓	✓			✓	✓	✓	✓
9 Bit with Bus-Driver Parity Input/Output Port		286		•		✓							
	CP	11286		✓									



### Translation Voltage Clamps

DESCRIPTION	TYPE	TECHNOLOGY	
		TVC	
10 Bit	3010	✓	
22 Bit	16222	✓	

### Voltage-Level Shifters

DESCRIPTION	TYPE	TECHNOLOGY	
		CD4K	
Quad Low to High	40109	✓	
Hex for TTL-to-CMOS or CMOS-to-CMOS Operation	4504	✓	

## TRANSCEIVERS

### Parity Transceivers

DESCRIPTION	OUTPUT	TYPE	TECHNOLOGY			
			ABT	ACT	ALS	F
Octal with Parity Generators/Checkers	3S	657	✓			✓
8 Bit to 9 Bit		833	✓			
		29833			✓	
		853	✓			
		29854			✓	
Dual 8 Bit to 9 Bit		16833	✓			
		16853	✓			
16 Bit with Parity Generators/Checkers	3S	16657	✓	✓		

## TRANSCEIVERS

### Registered Transceivers

DESCRIPTION	OUTPUT	TYPE	TECHNOLOGY																	
			ABT	AC	ACT	ALS	ALVC	AS	AVC	BCT	F	FCT	HC	HCT	LS	LVC	LVT			
Octal	3S	52										✓								
		543	✓		•						✓	✓	✓				✓	✓		
		11543			✓															
		561				✓														
		646	✓	✓	✓								✓	✓	✓	✓	✓	✓	✓	
		648				✓			✓							✓				
		651	✓																	
		652	✓	✓	✓									✓	✓	✓	✓	✓	✓	✓
		11652		✓	✓															
	OC/3S	653				✓														
		654				✓														
Octal with Series Damping Resistors	3S	2543											✓							
		2646											✓							
		2652												✓						
		2952	✓											✓				✓	✓	
16 Bit	3S	16470	✓																	
		16543	✓		✓		✓						✓				✓	✓		
		162543												✓						
		16646	✓		✓		✓		✓					✓				✓	✓	
		162646												✓						
		16651			✓															
		16652	✓	✓	✓									✓				✓	✓	
		162652													✓					
		16952	✓		✓		✓								✓			✓	✓	
		162952													✓					
18 Bit	3S	16524					✓													
		16525					✓													
		162525					✓													
32 Bit	3S	32543	✓																	
4 to 1 Multiplexed/Demultiplexed	3S	162460	✓																	

**Standard Transceivers**

DESCRIPTION	OUTPUT	TYPE	TECHNOLOGY																										
			ABT	ABTE	AC	ACT	AHC	AHCT	ALB	ALS	ALVC	ALVT	AS	AUC	AVC	BCT	64BCT	F	FCT	GTL	GTLP	HC	HCT	LS	LV	LVC	LVT		
Dual 1 Bit LVTTTL to GTLP Adjustable Edge Rate with Split LVTTTL Port, Feedback Path, and Selectable Polarity	3S	1395																				✓							
2 Bit LVTTTL to GTLP Adjustable Edge Rate with Selectable Parity	3S	1394																				✓							
Quad	3S	243								✓													✓	✓	✓				
Quad Tridirectional	3S	442																							✓				
7 Bit Bus Interface IEEE Std 1284	3S	1284				✓																							
8-Bit Transceivers and Transparent D-Type Latches with Four Independent Buffers		16973									✓																		
8 Bit LVTTTL to GTLP	3S	306																				✓							

## TRANSCIEVERS

### Standard Transceivers (continued)

DESCRIPTION	OUTPUT	TYPE	TECHNOLOGY																									
			ABT	ABTE	AC	ACT	AHC	AHCT	ALB	ALS	ALVC	ALVT	AS	AUC	AVC	BCT	64BCT	F	FCT	GTL	GTLP	HC	HCT	LS	LV	LVC	LVT	
Octal	3S	245	✓		✓	✓	✓	✓		✓	✓		✓	✓		✓	✓	✓	✓			✓	✓	✓	✓	✓	✓	
		1245								✓																		
		11245			✓	✓																						
		620	✓								✓																	
	OC	621								✓																		
	3S	623	✓		✓	✓					✓						✓		✓	✓			✓	✓	✓			
		638									✓			✓														
		639									✓																	
		640	✓								✓			✓			✓						✓	✓	✓			
		1640									✓																	
	OC	641									✓			✓											✓			
		642									✓														✓			
	3S	645									✓			✓									✓	✓	✓			
		1645									✓																	
Octal with Series Damping Resistors	3S	2245	✓															✓	✓							✓	✓	
Octal Transceivers and Line/MOS Drivers with B-Port Series Damping Resistors	3S	2245	✓																									
Octal with Adjustable Output Voltage	3S	3245																									✓	
Octal Dual Supply with Configurable Output Voltage	3S	4245																									✓	
Octal with 3.3-V to 5-V Shifters	3S	4245																									✓	
9 Bit	3S	863	✓																								✓	
		29863									✓																	
		29864																										

**Standard Transceivers (continued)**

DESCRIPTION	OUTPUT	TYPE	TECHNOLOGY																										
			ABT	ABTE	AC	ACT	AHC	AHCT	ALB	ALS	ALVC	ALVT	AS	AUC	AVC	BCT	64BCT	F	FCT	GTL	GTLP	HC	HCT	LS	LV	LVC	LVT		
10 Bit	3S	861	✓																								✓		
11 Bit Incident Wave Switching	3S/OC	16246		✓																									
16 Bit	3S	16245	✓		✓	✓		✓	✓		✓	✓		✓	✓				✓								✓	✓	
		16623	✓			✓																							
		16640	✓																										
16-Bit Bus Transceivers and Transparent D-Type Latches with Eight Independent Buffers											✓																		
16 Bit Incident Wave Switching	3S	16245		✓																									
16 Bit with Series Damping Resistors	3S	16245									✓	✓																	
		162245	✓									✓								✓							✓	✓	
16 Bit 3.3 V to 5 V Level Shifting	3S	164245									✓																		
16 Bit LVTTTL to GTLP Adjustable Edge Rate	3S	1645									✓																		
16 Bit LVTTTL to GTLP	3S	16945																											
18 Bit Bus Interface	3S	16863	✓			✓					✓																		
18 Bit LVTTTL to GTL/GTL+		16622																			✓								
		16923																				✓							
18 Bit LVTTTL to GTLP Source Synchronous Clock Outputs		16927																											
19 Bit Bus Interface IEEE Std 1284		161284																								✓	✓		

## TRANSCEIVERS

### Standard Transceivers (continued)

DESCRIPTION	OUTPUT	TYPE	TECHNOLOGY																									
			ABT	ABTE	AC	ACT	AHC	AHCT	ALB	ALS	ALVC	ALVT	AS	AUC	AVC	BCT	64BCT	F	FCT	GTL	GTLP	HC	HCT	LS	LV	LVC	LVT	
20 Bit	3S	16861				✓																						
25 Ω Octal	3S	25245	✓													✓	✓											
	OC	25642														✓												
32 Bit	3S	32245	✓								✓			✓													✓	✓
32 Bit LVTTTL to GTLP	3S	32945																			✓							
32 Bit LVTTTL to GTLP Adjustable Edge Rate	3S	3245																			✓							

## UNIVERSAL BUS FUNCTIONS

### Universal Bus Transceivers

DESCRIPTION	OUTPUT	TYPE	TECHNOLOGY												
			ABT	ALVC	ALVT	AUC	FCT	GTL	GTLP	LVC	LVT	VME			
8 Bit and Two 1-Bit Split Outputs with Feedback Path	3S	22501												✓	
16 Bit LVTTTL to GTL/GTL+ with Live Insertion		1655							✓						
16 Bit LVTTTL to GTLP Adjustable Edge Rate	3S	1655								✓					
17 Bit LVTTTL to GTLP Adjustable Edge Rate	3S	1616								✓					
17 Bit LVTTTL to GTL/GTL+		16616							✓						
17 Bit LVTTTL to GTLP with Buffered Clock	3S	16916								✓					
18 Bit	3S	16500	✓	✓				✓					✓		
		162500	✓					✓							
		16501	✓	✓		✓	✓						✓		
		162501	✓				✓								
		16600	✓	✓											
		16601	✓	✓	✓										
162601	✓	✓													
18 Bit with Parity Generators/Checkers	3S	16901		✓							✓				
18 Bit LVTTTL to GTL/GTL+		16612							✓						
18 Bit LVTTTL to GTLP	3S	16612								✓					
		16912								✓					
18 Bit LVTTTL to GTLP Adjustable Edge Rate	3S	1612								✓					
32 Bit	3S	32501	✓	✓											

## UNIVERSAL BUS FUNCTIONS

### Universal Bus Drivers

DESCRIPTION	OUTPUT	TYPE	TECHNOLOGY		
			ALVC	AVC	LVT
12 Bit with Parity Checker and Dual 3-State Outputs	3S	16903	✓		
16 Bit	3S	16334	✓	✓	
		162334	✓		
18 Bit	3S	16834	✓	✓	
		162834	✓		
		16835	✓	✓	✓
		162835	✓		
20 Bit	3S	162836	✓		

### Universal Bus Exchangers

DESCRIPTION	OUTPUT	TYPE	TECHNOLOGY		
			ABT	ALVC	AVC
9 Bit 4 Port	3S	16409		✓	
		162409		✓	
12 Bit to 24 Bit Multiplexed	3S	16271		✓	
12 Bit to 24 Bit Registered	3S	16269		✓	✓
		16270		✓	
		162268		✓	
16 Bit to 32 Bit with Byte Masks	3S	162280		✓	
16 Bit Tri-Port	3S	32316	✓		
18 Bit to 36 Bit Registered	3S	16282		✓	
		162282		✓	
18 Bit Tri-Port	3S	32318	✓		



LOGIC OVERVIEW	1
FOCUS ON NAVIGATING THE TI LOGIC WEB	2
FUNCTIONAL INDEX	3
<b>FUNCTIONAL CROSS-REFERENCE</b>	<b>4</b>
DEVICE SELECTION GUIDE	5
PACKAGING AND MARKING INFORMATION	A
LOGIC PURCHASING TOOL/ALTERNATE SOURCES	B

# 4

## FUNCTIONAL CROSS-REFERENCE

✓ Product available in technology indicated

● Product available in reduced-noise advanced CMOS (11000 series)

✦ New product planned in technology indicated

DEVICE	BiCMOS						BIPOLAR						CMOS														OTHER																										
	ABT	ALB	ALVT	BCT	64BCT	LVT	ALS	AS	F	LS	S	TTL	AC	ACT	AHC	AHCT	ALVC	AUC	AVC	CB3Q	CB3T	CBT	CBTLV	CD4K	FCT	HC	HCT	LV	LVC	TVC	ABTE	FB	FIFO	GTL	GTLP	HSTL	JTAG	PCA	PCF	SSTL	SSTU	SSTV	SSTVF	VME									
1G00															✓	✓		✓												✓																							
1G02															✓	✓		✓													✓																						
1G04															✓	✓		✓													✓																						
1GU04															✓			✓													✓																						
1G06																		✓													✓																						
1G07																		✓													✓																						
1G08															✓	✓		✓													✓																						
1G10																		✓													+																						
1G11																		+													+																						
1G14															✓	✓		✓													✓																						
1G17																		✓													✓																						
1G18																		+													✓																						
1G19																		+													+																						
1G27																		+													+																						
1G32															✓	✓		✓													✓																						
1G57																		+													✓																						
1G58																		+													✓																						
1G66																		✓													✓																						
1G79																		✓													✓																						
1G80																		✓													✓																						
1G86															✓	✓		✓													✓																						
1G97																		+													✓																						
1G98																		+													✓																						
1G125															✓	✓		✓					✓	✓							✓																						
1G126															✓	✓		✓													✓																						
1G240																		✓													✓																						
1G332																		+													✓																						
1G384																							✓																														
1G386																			✓												✓																						
1G3157																			✓												✓																						



DEVICE	BICMOS						BIPOLAR						CMOS														OTHER																											
	ABT	ALB	ALVT	BCT	64BCT	LVT	ALS	AS	F	LS	S	TTL	AC	ACT	AHC	AHCT	ALVC	AUC	AVC	CB3Q	CB3T	CBT	CBTLV	CD4K	FCT	HC	HCT	LV	LVC	TVC	ABTE	FB	FIFO	GTL	GTLP	HSTL	JTAG	PCA	PCF	SSTL	SSTU	SSTV	SSTVF	VME										
02							✓	✓	✓	✓	✓	✓	✓	✓	✓	✓											✓	✓	✓	✓																								
03							✓																					✓	✓	✓																								
04							✓	✓	✓	✓	✓	✓	•	•	✓	✓	✓											✓	✓	✓	✓																							
U04															✓													✓	✓	✓	✓																							
05							✓			✓	✓		✓	✓	✓													✓		✓	✓																							
06										✓				✓																✓	✓	✓																						
07										✓				✓															✓	✓	✓	✓																						
08							✓	✓	✓	✓	✓		•	•	✓	✓	✓											✓	✓	✓	✓																							
09							✓			✓	✓																																											
10							✓	✓	✓	✓	✓	✓	✓	✓	✓		✓											✓	✓	✓	✓																							
11							✓	✓	✓	✓	✓		•	•	✓			✓										✓	✓	✓	✓																							
14									✓		✓		✓	✓	✓	✓	✓											✓	✓	✓	✓																							
16											✓	✓																																										
17											✓																																											
19										✓																																												
20							✓	✓	✓	✓	✓		✓	✓														✓	✓	✓																								
21							✓	✓	✓	✓																		✓	✓	✓																								
25											✓																																											
26										✓																																												
27							✓	✓	✓	✓																		✓	✓	✓																								
30							✓	✓	✓	✓				•														✓	✓																									
31										✓																																												
32							✓	✓	✓	✓	✓	✓	•	•	✓	✓	✓											✓	✓	✓	✓																							
33							✓			✓																																												
35							✓																																															
37							✓			✓	✓	✓	✓																																									
38							✓		✓	✓	✓	✓	✓																																									
42										✓																		✓	✓																									
45												✓																																										
47										✓	✓																																											
51										✓	✓																																											



DEVICE	BiCMOS						BIPOLAR						CMOS																	OTHER																													
	ABT	ALB	ALVT	BCT	64BCT	LVT	ALS	AS	F	LS	S	TTL	AC	ACT	AHC	AHCT	ALVC	AUC	AVC	CB3Q	CB3T	CBT	CBTLV	CD4K	FCT	HC	HCT	LV	LVC	TVC	ABTE	FB	FIFO	GTL	GTLP	HSTL	JTAG	PCA	PCF	SSTL	SSTU	SSTV	SSTVF	VME															
150																																																											
151							✓	✓	✓	✓	✓		✓	✓													✓	✓	✓																														
153							✓	✓	✓	✓	✓		✓	✓													✓	✓	✓																														
154												✓															✓	✓																															
155																																																											
156							✓																																																				
157							✓	✓	✓	✓	✓		✓	✓	✓	✓									✓	✓	✓	✓	✓		✓																												
158							✓	✓		✓	✓		✓	✓	✓	✓									✓	✓	✓	✓	✓																														
159												✓																																															
161							✓	✓	✓	✓	✓		✓	✓													✓	✓	✓	✓	✓																												
163							✓	✓	✓	✓	✓		✓	✓											✓	✓	✓	✓	✓																														
164							✓			✓			✓	✓													✓	✓	✓	✓	✓																												
165							✓			✓			✓	✓												✓	✓	✓	✓	✓																													
166							✓			✓			✓	✓												✓	✓	✓	✓	✓																													
169							✓	✓	✓	✓	✓		✓	✓												✓	✓	✓	✓	✓																													
170										✓			✓	✓													✓	✓	✓	✓																													
173										✓			✓	✓													✓	✓	✓																														
174							✓	✓	✓	✓	✓		✓	✓	✓												✓	✓	✓	✓	✓																												
175							✓	✓	✓	✓	✓	✓	✓	✓	✓	✓											✓	✓	✓	✓	✓																												
181								✓		✓			✓	✓													✓	✓	✓	✓																													
182											✓																																																
190																											✓	✓	✓																														
191							✓			✓			✓	✓												✓	✓	✓	✓																														
192																											✓	✓	✓																														
193							✓			✓			✓	✓													✓	✓	✓	✓																													
194								✓		✓			✓	✓													✓	✓	✓	✓																													
195																											✓	✓	✓																														
215																											✓	✓	✓																														
221										✓			✓	✓													✓	✓	✓	✓																													
224																																																											
225										✓																																																	





DEVICE	BiCMOS						BIPOLAR						CMOS														OTHER																											
	ABT	ALB	ALVT	BCT	64BCT	LVT	ALS	AS	F	LS	S	TTL	AC	ACT	AHC	AHCT	ALVC	AUC	AVC	CB3Q	CB3T	CBT	CBTLV	CDAK	FCT	HC	HCT	LV	LVC	TVC	ABTE	FB	FIFO	GTL	GTLP	HSTL	JTAG	PCA	PCF	SSTL	SSTU	SSTV	SSTVF	VME										
297									✓					✓													✓	✓																										
298								✓																																														
299							✓		✓				✓	✓														✓	✓																									
306																																																						
321																																																						
323							✓						✓																																									
348																																																						
354																												✓	✓																									
356																																																						
365																												✓	✓																									
366																												✓	✓																									
367																✓	✓											✓	✓	✓		✓																						
368																												✓	✓	✓		✓																						
373	✓			✓		✓	✓	✓	✓	✓	✓		✓	✓	✓	✓	✓										✓	✓	✓	✓	✓	✓																						
374	✓			✓		✓	✓	✓	✓	✓	✓		✓	✓	✓	✓	✓									✓	✓	✓	✓	✓	✓	✓																						
375																																																						
377	✓								✓	✓																	✓	✓	✓																									
378																																																						
381																																																						
390																																																						
393																																																						
399																																																						
423																																																						
442																																																						
465																																																						
480																																																						
518																																																						
520																																																						
521																																																						
533	✓																																																					
534	✓																																																					







DEVICE	BICMOS						BIPOLAR						CMOS														OTHER																								
	ABT	ALB	ALVT	BCT	64BCT	LVT	ALS	AS	F	LS	S	TTL	AC	ACT	AHC	AHCT	ALVC	AUC	AVC	CB3Q	CB3T	CBT	CBTLV	CD4K	FCT	HC	HCT	LV	LVC	TVC	ABTE	FB	FIFO	GTL	GTLP	HSTL	JTAG	PCA	PCF	SSTL	SSTU	SSTV	SSTVF	VME							
1035							✓																																												
1050																																																			
1051																																																			
1052																																																			
1053																																																			
1056																																																			
1071																																																			
1073																																																			
1244																																																			
1245																																																			
1284																																																			
1394																																																			
1395																																																			
1612																																																			
1616																																																			
1640																																																			
1645																																																			
1650																																																			
1651																																																			
1653																																																			
1655																																																			
1804																																																			
2031																																																			
2033																																																			
2034																																																			
2040																																																			
2041																																																			
2226																																																			
2227																																																			
2228																																																			
2229																																																			









DEVICE	BICMOS						BIPOLAR						CMOS														OTHER																														
	ABT	ALB	ALVT	BCT	64BCT	LVT	ALS	AS	F	LS	S	TTL	AC	ACT	AHC	AHCT	ALVC	AUC	AVC	CB3Q	CB3T	CBT	CBTLV	CDAK	FCT	HC	HCT	LV	LVC	TVC	ABTE	FB	FIFO	GTL	GTLP	HSTL	JTAG	PCA	PCF	SSTL	SSTU	SSTV	SSTVF	VME													
4059																									✓		✓																														
4060																									✓		✓	✓																													
4063																									✓		✓																														
4066																									✓		✓	✓	✓																												
4067																									✓		✓	✓																													
4068																									✓		✓																														
4069																									✓		✓																														
4070																									✓		✓																														
4071																									✓		✓																														
4072																									✓		✓																														
4073																									✓		✓																														
4075																									✓		✓																														
4076																									✓		✓																														
4077																									✓		✓																														
4078																									✓		✓																														
4081																									✓		✓																														
4082																									✓		✓																														
4085																									✓		✓																														
4086																									✓		✓																														
4089																									✓		✓																														
4093																									✓		✓																														
4094																									✓		✓																														
4097																									✓		✓																														
4098																									✓		✓																														
4099																									✓		✓																														
4245																																																									
4316																											✓		✓																												
4351																											✓		✓																												
4352																											✓		✓																												
4374																											✓		✓																												
4502																										✓		✓																													



DEVICE	BiCMOS						BIPOLAR						CMOS													OTHER																																
	ABT	ALB	ALVT	BCT	64BCT	LVT	ALS	AS	F	LS	S	TTL	AC	ACT	AHC	AHCT	ALVC	AUC	AVC	CB3Q	CB3T	CBT	CBTLV	CD4K	FCT	HC	HCT	LV	LVC	TVC	ABTE	FB	FIFO	GTL	GTLP	HSTL	JTAG	PCA	PCF	SSTL	SSTU	SSTV	SSTVF	VME														
7002																											✓																															
7032																												✓																														
7046																											✓		✓																													
7266																											✓																															
7802																																																										
7803																																																										
7804																																																										
7805																																																										
7806																																																										
7807																																																										
7808																																																										
7811																																																										
7813																																																										
7814																																																										
7819																																																										
7820																																																										
7881																																																										
7882																																																										
8003								✓																																																		
8240																																																										
8244																																																										
8245																																																										
8373																																																										
8374																																																										
8543																																																										
8550																																																										
8574																																																										
8646																																																										
8652																																																										
8952																																																										
8980																																																										



DEVICE	BiCMOS						BIPOLAR					CMOS														OTHER																										
	ABT	ALB	ALVT	BCT	64BCT	LVT	ALS	AS	F	LS	S	TTL	AC	ACT	AHC	AHCT	ALVC	AUC	AVC	CB3Q	CB3T	CBT	CBTLV	CD4K	FCT	HC	HCT	LV	LVC	TVC	ABTE	FB	FIFO	GTL	GTLPL	HSTL	JTAG	PCA	PCF	SSTL	SSTU	SSTV	SSTVF	VME								
16232																																																				
16233																																																				
16240	✓		✓			✓								✓	✓	✓	✓	✓								✓					✓																					
16241	✓					✓																																														
16244	✓	✓	✓			✓							✓	✓	✓	✓	✓	✓	✓				✓			✓					✓																					
16245	✓	✓				✓							✓	✓		✓	✓	✓	✓				✓		✓						✓				✓																	
16246																																		✓																		
16260	✓																																																			
16269																																																				
16270																																																				
16271																																																				
16282																																																				
16292																																																				
16334																																																				
16344																																																				
16373	✓		✓			✓							✓	✓	✓	✓	✓	✓	✓							✓					✓																					
16374	✓		✓			✓							✓	✓	✓	✓	✓	✓	✓							✓					✓																					
16390																																																				
16409																																																				
16460	✓																																																			
16470	✓																																																			
16500	✓					✓																																														
16501	✓					✓																																														
16524																																																				
16525																																																				
16540	✓															✓	✓																																			
16541	✓					✓							✓	✓	✓	✓																																				
16543	✓					✓							✓	✓													✓																									
16600	✓																																																			
16601	✓		✓																																																	
16612																																																				









DEVICE	BiCMOS						BIPOLAR						CMOS													OTHER																													
	ABT	ALB	ALVT	BCT	64BCT	LVT	ALS	AS	F	LS	S	TTL	AC	ACT	AHC	AHCT	ALVC	AUC	AVC	CB3Q	CB3T	CBT	CBTLV	CDAK	FCT	HC	HCT	LV	LVC	TVC	ABTE	FB	FIFO	GTL	GTLP	HSTL	JTAG	PCA	PCF	SSTL	SSTU	SSTV	SSTVF	VME											
40161																									✓																														
40174																									✓																														
40175																									✓																														
40192																									✓																														
40193																									✓																														
40194																									✓																														
40257																									✓																														
161284																													✓			✓																							
162240																											✓																												
162241																																																							
162244	✓		✓														✓										✓																												
162245	✓																										✓																												
162260	✓																																																						
162268																																																							
162280																																																							
162282																																																							
162334																																																							
162344																																																							
162373																																																							
162374																																																							
162409																																																							
162460	✓																																																						
162500	✓																																																						
162501	✓																																																						
162525																																																							
162541																																																							
162543																																																							
162601	✓																																																						
162646																																																							
162652																																																							
162721																																																							



LOGIC OVERVIEW	1
FOCUS ON NAVIGATING THE TI LOGIC WEB	2
FUNCTIONAL INDEX	3
FUNCTIONAL CROSS-REFERENCE	4
<b>DEVICE SELECTION GUIDE</b>	<b>5</b>
PACKAGING AND MARKING INFORMATION	A
LOGIC PURCHASING TOOLS/ALTERNATE SOURCES	B

# 4

## DEVICE SELECTION GUIDE

## SECTION 5 DEVICE SELECTION GUIDE

---

### CONTENTS

<b>ABT</b> – Advanced BiCMOS Technology Logic .....	5–5
<b>ABTE/ETL</b> – Advanced BiCMOS Technology/Enhanced Transceiver Logic .....	5–13
<b>AC/ACT</b> – Advanced CMOS Logic .....	5–15
<b>AHC/AHCT</b> – Advanced High-Speed CMOS Logic .....	5–23
<b>ALB</b> – Advanced Low-Voltage BiCMOS Logic .....	5–29
<b>ALS</b> – Advanced Low-Power Schottky Logic .....	5–31
<b>ALVC</b> – Advanced Low-Voltage CMOS Technology Logic .....	5–37
<b>ALVT</b> – Advanced Low-Voltage BiCMOS Technology Logic .....	5–43
<b>AS</b> – Advanced Schottky Logic .....	5–45
<b>AUC</b> – Advanced Ultra-Low-Voltage CMOS Logic .....	5–49
<b>AVC</b> – Advanced Very-Low-Voltage CMOS Logic .....	5–53
<b>BCT</b> – BiCMOS Technology Logic .....	5–55
<b>64BCT</b> – 64-Series BiCMOS Technology Logic .....	5–55
<b>BTA</b> – Bus-Termination Arrays .....	5–59
<b>CB3Q</b> – Low-Voltage High-Bandwidth Bus-Switch Crossbar Technology Logic .....	5–61
<b>CB3T</b> – Low-Voltage Translator Bus-Switch Crossbar Technology Logic .....	5–63
<b>CBT</b> – Crossbar Technology Logic .....	5–65
<b>CBTLV</b> – Low-Voltage Crossbar Technology Logic .....	5–69
<b>CD4000</b> – CMOS B-Series Integrated Circuits .....	5–71
<b>74F</b> – Fast Logic .....	5–75
<b>FB+/BTL</b> – FutureBus+/Backplane Transceiver Logic .....	5–79
<b>FCT</b> – Fast CMOS TTL Logic .....	5–81
<b>FIFO</b> – First-In, First-Out Memories .....	5–87
<b>GTL</b> – Gunning Transceiver Logic .....	5–91
<b>GTLF</b> – Gunning Transceiver Logic Plus .....	5–93
<b>HC/HCT</b> – High-Speed CMOS Logic .....	5–99
<b>IEEE Std 1149.1 (JTAG) Boundary-Scan Logic</b> .....	5–109
<b>Little Logic</b> .....	5–113
<b>LS</b> – Low-Power Schottky Logic .....	5–119
<b>LV</b> – Low-Voltage CMOS Technology Logic .....	5–125
<b>LVC</b> – Low-Voltage CMOS Technology Logic .....	5–129
<b>LVT</b> – Low-Voltage BiCMOS Technology Logic .....	5–137
<b>PCA/PCF</b> – I <sup>2</sup> C Inter-Integrated Circuit Applications .....	5–143
<b>S</b> – Schottky Logic .....	5–145
<b>SSTL</b> – Stub Series-Terminated Logic .....	5–149
<b>HSTL</b> – High-Speed Transceiver Logic .....	5–149
<b>SSTU</b> – Stub Series-Terminated Ultra-Low-Voltage Logic .....	5–151
<b>SSTV/SSTVF</b> – Stub Series-Terminated Low-Voltage Logic .....	5–155
<b>TTL</b> – Transistor-Transistor Logic .....	5–159
<b>TVC</b> – Translation Voltage Clamp Logic .....	5–161
<b>VME</b> – VERSAmodule Eurocard Bus Technology .....	5–163

## **ABT**

### **Advanced BiCMOS Technology Logic**

The ABT family, TI's second-generation family of BiCMOS bus-interface products, is manufactured using a 0.8- $\mu$  BiCMOS process. It provides high drive up to 64 mA and propagation delays in the 5-ns range, while maintaining very low power consumption. ABT products are well suited for live-insertion applications, with an  $I_{off}$  specification of 0.1 mA and power-up 3-state (PU3S) circuitry.

The ABT family offers series-damping-resistor options where reduced transmission-line effects are required. Special ABT parts that provide high-current drive (180 mA) for use with 25- $\Omega$  transmission lines also are offered. Advanced bus functions, such as UBT™ transceivers, emulate a wide variety of bus-interface functions. Multiplexing options for memory interleaving and bus upsizing or downsizing also are provided.

The ABT devices can be purchased in octal, Widebus™, or Widebus+™. The Widebus and Widebus+ packages feature higher performance, with reduced noise and flow-through pinout for easier board layout. Widebus+ devices offer input bus-hold circuitry to eliminate the need for external pullup resistors for floating inputs.

See [www.ti.com/sc/logic](http://www.ti.com/sc/logic) for the most current data sheets.

# DEVICE SELECTION GUIDE

## ABT

DEVICE	NO. PINS	DESCRIPTION	AVAILABILITY										LITERATURE REFERENCE		
			MIL	PDIP	QFN	QFP	SOIC	SOP	SSOP	TQFP	TSSOP	TVSOP		VFBGA	
SN74ABT125	14	Quad Bus Buffers with 3-State Outputs	✓	✓	✓		✓	✓	✓			✓			SCBS182
SN74ABT126	14	Quad Bus Buffers with 3-State Outputs		✓	✓		✓	✓	✓			✓			SCBS183
SN74ABT240A	20	Octal Buffers/Drivers with 3-State Outputs	✓	✓			✓	✓	✓			✓			SCBS098
SN74ABT241	20	Octal Buffers/Drivers with 3-State Outputs	✓												SCBS184
SN74ABT241A	20	Octal Buffers/Drivers with 3-State Outputs		✓			✓	✓	✓			✓			SCBS184
SN54ABT244	20	Octal Buffers and Line Drivers with 3-State Outputs	✓												SCBS099
SN74ABT244A	20	Octal Buffers and Line Drivers with 3-State Outputs		✓			✓	✓	✓			✓			SCBS099
SN74ABT245A	20	Octal Bus Transceivers with 3-State Outputs	✓												SCBS081
SN74ABT245B	20	Octal Bus Transceivers with 3-State Outputs		✓	✓		✓	✓	✓			✓	✓	✓	SCBS081
SN74ABTH245	20	Octal Bus Transceivers with 3-State Outputs	✓	✓			✓		✓			✓	✓		SCBS663
SN74ABT273	20	Octal D-Type Flip-Flops with Clear	✓	✓			✓	✓	✓			✓			SCBS185
SN74ABT373	20	Octal Transparent D-Type Latches with 3-State Outputs	✓	✓			✓	✓	✓			✓			SCBS155
SN54ABT374	20	Octal D-Type Edge-Triggered Flip-Flops with 3-State Outputs	✓												SCBS111
SN74ABT374A	20	Octal D-Type Edge-Triggered Flip-Flops with 3-State Outputs		✓			✓	✓	✓			✓			SCBS111
SN74ABT377	20	Octal D-Type Flip-Flops with Enable	✓												SCBS156
SN74ABT377A	20	Octal D-Type Flip-Flops with Enable	✓	✓			✓	✓	✓			✓			SCBS156
SN74ABT533	20	Octal Inverting Transparent Latches with 3-State Outputs	✓												SCBS186
SN74ABT533A	20	Octal Inverting Transparent Latches with 3-State Outputs	✓	✓			✓	✓	✓			✓			SCBS186

### commercial package description and availability

#### DSBGA (die-size ball grid array)†

YEA, YZA = 5/6/8 pins  
YEP, YZP = 5/6/8 pins

#### LFBGA (low-profile fine-pitch ball grid array)

GGM = 80/100 pins  
GKE, ZKE = 96 pins  
GKF, ZKF = 114 pins

#### VFBGA (very-thin-profile fine-pitch ball grid array)

GQN, ZQN = 20 pins  
GQL, ZQL = 56 pins (also includes 48-pin functions)

#### schedule

✓ = Now    ✚ = Planned

#### PDIP (plastic dual-in-line package)

P = 8 pins  
N = 14/16/20/24 pins  
NT = 24/28 pins

#### PLCC (plastic leaded chip carrier)

FN = 20/28/44/68/84 pins

#### SOIC (small-outline integrated circuit)

D = 8/14/16 pins  
DW = 16/18/20/24/28 pins

#### SOT (small-outline transistor)

PK = 3 pins  
DBV = 3/4/5 pins  
DCY = 4 pins  
DCK = 5/6 pins

#### QFN (quad flatpack no lead)

RGY = 14/16/20 pins  
RGQ = 56 pins

#### QFP (quad flatpack)

RC = 52 pins (FB only)  
PH = 80 pins (FIFOs only)  
PQ = 100/132 pins (FIFOs only)

#### LQFP (low-profile quad flatpack)

PZA = 80 pins

#### TQFP (plastic thin quad flatpack)

PAH = 52 pins  
PAG = 64 pins (FB only)  
PM = 64 pins  
PN = 80 pins  
PCA, PZ = 100 pins (FB only)  
PCB = 120 pins (FIFOs only)

#### SOP (small-outline package)

PS = 8 pins  
NS = 14/16/20/24 pins

#### QSOP (quarter-size small-outline package)

DBQ = 16/20/24 pins

#### SSOP (shrink small-outline package)

DCT = 8 pins  
DB = 14/16/20/24/28/30/38 pins  
DBQ = 16/20/24 pins  
DL = 28/48/56 pins

#### TSSOP (thin shrink small-outline package)

PW = 8/14/16/20/24/28 pins  
DGG = 48/56/64 pins

#### TVSOP (thin very small-outline package)

DGV = 14/16/20/24/48/56 pins  
DBB = 80/100 pins

#### VSSOP (very thin shrink small-outline package)

DCU = 8 pins

† JEDEC reference for wafer chip scale package (WCSP)



DEVICE	NO. PINS	DESCRIPTION	AVAILABILITY											LITERATURE REFERENCE		
			MIL	PDIP	QFN	QFP	SOIC	SOP	SSOP	TQFP	TSSOP	TVSOP	VFBGA			
SN74ABT534	20	Octal D-Type Inverting Flip-Flops with 3-State Outputs	✓													SCBS187
SN74ABT534A	20	Octal D-Type Inverting Flip-Flops with 3-State Outputs	✓	✓				✓	✓	✓			✓			SCBS187
SN74ABT540	20	Inverting Octal Buffers and Line Drivers with 3-State Outputs		✓				✓	✓	✓						SCBS188
SN54ABT541	20	Octal Buffers and Line Drivers with 3-State Outputs	✓													SCBS093
SN74ABT541B	20	Octal Buffers and Line Drivers with 3-State Outputs		✓				✓	✓	✓			✓			SCBS093
SN74ABT543	24	Octal Registered Transceivers with 3-State Outputs	✓													SCAS422
SN74ABT543A	24	Octal Registered Transceivers with 3-State Outputs	✓	✓				✓	✓	✓			✓			SCBS157
SN74ABT573	20	Octal Transparent D-Type Latches with 3-State Outputs	✓													SCBS190
SN74ABT573A	20	Octal Transparent D-Type Latches with 3-State Outputs	✓	✓	✓			✓	✓	✓			✓		✓	SCBS190
SN54ABT574	20	Octal Edge-Triggered D-Type Flip-Flops with 3-State Outputs	✓													SCBS191
SN74ABT574A	20	Octal Edge-Triggered D-Type Flip-Flops with 3-State Outputs	✓	✓	✓			✓	✓	✓			✓		✓	SCBS191
SN74ABT620	20	Octal Bus Transceivers with 3-State Outputs		✓				✓	✓	✓						SCBS113
SN74ABT623	20	Octal Bus Transceivers with 3-State Outputs	✓	✓				✓	✓	✓			✓			SCBS114
SN74ABT640	20	Octal Bus Transceivers with 3-State Outputs		✓				✓	✓	✓			✓			SCBS104
SN74ABT646	24	Octal Registered Bus Transceivers with 3-State Outputs		✓				✓		✓			✓	✓		SCBS068
SN74ABT646A	24	Octal Registered Bus Transceivers with 3-State Outputs	✓	✓				✓	✓	✓			✓	✓		SCBS069
SN74ABT651	24	Octal Bus Transceivers and Registers with 3-State Outputs		✓				✓	✓	✓						SCBS083
SN74ABT652A	24	Octal Bus Transceivers and Registers with 3-State Outputs	✓	✓				✓	✓	✓						SCBS072
SN74ABT657A	24	Octal Bus Transceivers with Parity Generators/Checkers and 3-State Outputs		✓				✓	✓	✓						SCBS192
SN54ABT821	24	10-Bit Bus-Interface Flip-Flops with 3-State Outputs	✓													SCBS193
SN74ABT821A	24	10-Bit Bus-Interface Flip-Flops with 3-State Outputs	✓	✓				✓	✓	✓						SCBS193
SN74ABT823	24	9-Bit Bus-Interface Flip-Flops with 3-State Outputs	✓	✓				✓	✓	✓						SCBS158
SN74ABT827	24	10-Bit Buffers/Drivers with 3-State Outputs	✓	✓				✓	✓	✓			✓			SCBS159



# DEVICE SELECTION GUIDE

## ABT

DEVICE	NO. PINS	DESCRIPTION	AVAILABILITY											LITERATURE REFERENCE		
			MIL	PDIP	QFN	QFP	SOIC	SOP	SSOP	TQFP	TSSOP	TVSOP	VFBGA			
SN74ABT833	24	8-Bit to 9-Bit Parity Bus Transceivers	✓	✓			✓	✓								SCBS195
SN74ABT841	24	10-Bit Bus-Interface D-Type Latches with 3-State Outputs	✓													SCBS196
SN74ABT841A	24	10-Bit Bus-Interface D-Type Latches with 3-State Outputs		✓			✓	✓	✓			✓				SCBS196
SN74ABT843	24	9-Bit Bus-Interface D-Type Latches with 3-State Outputs	✓	✓			✓	✓	✓			✓				SCBS197
SN74ABT853	24	8-Bit to 9-Bit Parity Bus Transceivers	✓	✓			✓	✓	✓			✓				SCBS198
SN74ABT861	24	10-Bit Transceivers with 3-State Outputs		✓			✓	✓								SCBS199
SN74ABT863	24	9-Bit Bus Transceivers with 3-State Outputs		✓			✓		✓							SCBS201
SN74ABT2240A	20	Octal Buffers and Line/MOS Drivers with Series Damping Resistors and 3-State Outputs	✓	✓			✓	✓	✓			✓				SCBS232
SN74ABT2241	20	Octal Buffers and Line/MOS Drivers with Series Damping Resistors and 3-State Outputs		✓			✓	✓	✓			✓				SCBS233
SN74ABT2244A	20	Octal Buffers/Line Drivers with Series Damping Resistors and 3-State Outputs	✓	✓			✓	✓	✓			✓				SCBS106
SN74ABT2245	20	Octal Transceivers and Line MOS Drivers with Series Damping Resistors and 3-State Outputs	✓	✓			✓	✓	✓			✓				SCBS234
SN74ABTR2245	20	Octal Transceivers and Line MOS Drivers with Series Damping Resistors and 3-State Outputs		✓			✓	✓	✓			✓	✓			SCBS680
SN74ABT2827	24	10-Bit Buffers/Drivers with Series Damping Resistors and 3-State Outputs		✓			✓									SCBS648
SN74ABT2952A	24	Octal Bus Transceivers and Registers with 3-State Outputs	✓	✓			✓	✓	✓							SCBS203
SN74ABT5400A	28	11-Bit Line/Memory Drivers with 3-State Outputs					✓									SCBS661
SN74ABT5401	28	11-Bit Line/Memory Drivers with 3-State Outputs					✓									SCBS235
SN74ABT5402A	28	12-Bit Line/Memory Drivers with 3-State Outputs					✓									SCBS660
SN74ABT5403	28	12-Bit Line/Memory Drivers with 3-State Outputs					✓									SCBS236
SN74ABT16240A	48	16-Bit Buffers/Drivers with 3-State Outputs	✓							✓		✓	✓			SCBS095
SN74ABT16241A	48	16-Bit Buffers/Drivers with 3-State Outputs	✓							✓		✓	✓			SCBS096
SN74ABT16244A	48	16-Bit Buffers/Drivers with 3-State Outputs								✓		✓	✓			SCBS073

DEVICE	NO. PINS	DESCRIPTION	AVAILABILITY											LITERATURE REFERENCE		
			MIL	PDIP	QFN	QFP	SOIC	SOP	SSOP	TQFP	TSSOP	TVSOP	VFBGA			
SN74ABTH16244	48	16-Bit Buffers/Drivers with 3-State Outputs	✓								✓		✓			SCBS677
SN74ABT16245A	48	16-Bit Bus Transceivers with 3-State Outputs									✓		✓	✓		SCBS300
SN74ABTH16245	48	16-Bit Bus Transceivers with 3-State Outputs	✓								✓		✓	✓		SCBS662
SN74ABTH16260	56	12-Bit to 24-Bit Multiplexed D-Type Latches with 3-State Outputs	✓								✓					SCBS204
SN74ABT16373A	48	16-Bit Transparent D-Type Latches with 3-State Outputs	✓								✓		✓			SCBS160
SN74ABT16374A	48	16-Bit Edge-Triggered D-Type Flip-Flops with 3-State Outputs	✓								✓		✓			SCBS205
SN74ABTH16460	56	4-to-1 Multiplexed/Demultiplexed Transceivers with 3-State Outputs									✓		✓			SCBS207
SN74ABT16470	56	16-Bit Registered Transceivers with 3-State Outputs									✓		✓			SCBS085
SN74ABT16500B	56	18-Bit Universal Bus Transceivers with 3-State Outputs									✓		✓			SCBS057
SN74ABT16501	56	18-Bit Universal Bus Transceivers with 3-State Outputs									✓		✓			SCBS086
SN74ABT16540A	48	16-Bit Buffers/Drivers with 3-State Outputs									✓		✓	✓		SCBS208
SN74ABT16541A	48	16-Bit Buffers/Drivers with 3-State Outputs									✓		✓	✓		SCBS118
SN74ABT16543	56	16-Bit Registered Transceivers with 3-State Outputs	✓								✓		✓			SCBS087
SN74ABT16600	56	18-Bit Universal Bus Transceivers with 3-State Outputs									✓		✓			SCBS209
SN74ABT16601	56	18-Bit Universal Bus Transceivers with 3-State Outputs	✓								✓		✓			SCBS210
SN74ABT16623	48	16-Bit Bus Transceivers with 3-State Outputs									✓		✓			SCBS211
SN74ABT16640	48	16-Bit Bus Transceivers with 3-State Outputs	✓								✓		✓			SCBS107
SN74ABT16646	56	16-Bit Bus Transceivers and Registers with 3-State Outputs	✓								✓		✓			SCBS212
SN74ABT16652	56	16-Bit Bus Transceivers and Registers with 3-State Outputs	✓								✓					SCBS215
SN74ABT16657	56	16-Bit Transceivers with Parity Generators/Checkers and 3-State Outputs									✓		✓			SCBS103
SN74ABT16821	56	20-Bit D-Type Flip-Flops with 3-State Outputs									✓		✓			SCBS216
SN74ABT16823	56	18-Bit D-Type Flip-Flops with 3-State Outputs	✓								✓		✓			SCBS217

# DEVICE SELECTION GUIDE

## ABT

DEVICE	NO. PINS	DESCRIPTION	AVAILABILITY											LITERATURE REFERENCE		
			MIL	PDIP	QFN	QFP	SOIC	SOP	SSOP	TQFP	TSSOP	TVSOP	VFBGA			
SN74ABTH16823	56	18-Bit D-Type Flip-Flops with 3-State Outputs									✓		✓			SCBS664
SN74ABT16825	56	18-Bit Buffers/Drivers with 3-State Outputs									✓					SCBS218
SN74ABT16827	56	20-Bit Buffers/Drivers with 3-State Outputs									✓				✓	SCBS220
SN74ABT16833	56	Dual 8-Bit to 9-Bit Parity Bus Transceivers									✓		✓			SCBS097
SN74ABT16841	56	20-Bit Bus-Interface D-Type Latches with 3-State Outputs	✓								✓					SCBS222
SN74ABT16843	56	18-Bit Bus-Interface D-Type Latches with 3-State Outputs									✓		✓			SCBS223
SN74ABT16853	56	Dual 8-Bit to 9-Bit Parity Bus Transceivers									✓		✓			SCBS153
SN74ABT16863	56	18-Bit Bus-Interface Transceivers with 3-State Outputs									✓					SCBS225
SN74ABT16952	56	16-Bit Registered Transceivers with 3-State Outputs	✓								✓		✓			SCBS082
SN74ABTH25245	24	25-Ω Octal Bus Transceivers with 3-State Outputs		✓				✓								SCBS251
SN74ABTH32245	100	32-Bit Bus Transceivers with 3-State Outputs											✓			SCBS228
SN74ABTH32316	80	16-Bit Tri-Port Universal Bus Exchangers	✓				✓									SCBS179
SN74ABTH32318	80	18-Bit Tri-Port Universal Bus Exchangers					✓									SCBS180
SN74ABTH32501	100	32-Bit Universal Bus Transceivers with 3-State Outputs											✓			SCBS229
SN74ABTH32543	100	32-Bit Registered Bus Transceivers with 3-State Outputs											✓			SCBS230
SN74ABT162244	48	16-Bit Buffers/Drivers with Series Damping Resistors and 3-State Outputs	✓								✓		✓	✓		SCBS238
SN74ABT162245	48	16-Bit Bus Transceivers with Series Damping Resistors and 3-State Outputs	✓								✓		✓			SCBS239
SN74ABTH162245	48	16-Bit Bus Transceivers with Series Damping Resistors and 3-State Outputs									✓		✓	✓		SCBS712
SN74ABTH162260	56	12-Bit to 24-Bit Multiplexed D-Type Latches with Series Damping Resistors and 3-State Outputs									✓					SCBS240
SN74ABTH162460	56	4-to-1 Multiplexed/Demultiplexed Registered Transceivers with 3-State Outputs									✓		✓			SCBS241
SN74ABT162500	56	18-Bit Universal Bus Transceivers with 3-State Outputs									✓					SCBS242

DEVICE	NO. PINS	DESCRIPTION	AVAILABILITY											LITERATURE REFERENCE		
			MIL	PDIP	QFN	QFP	SOIC	SOP	SSOP	TQFP	TSSOP	TVSOP	VFBGA			
SN74ABT162501	56	18-Bit Universal Bus Transceivers with 3-State Outputs									✓		✓			SCBS243
SN74ABT162601	56	18-Bit Universal Bus Transceivers with 3-State Outputs	✓								✓		✓			SCBS247
SN74ABT162823A	56	18-Bit Bus-Interface Flip-Flops with 3-State Outputs									✓		✓			SCBS666
SN74ABT162825	56	18-Bit Buffers/Drivers with Series Damping Resistors and 3-State Outputs									✓					SCBS474
SN74ABT162827A	56	20-Bit Buffers/Drivers with Series Damping Resistors and 3-State Outputs									✓		✓			SCBS248
SN74ABT162841	56	20-Bit Bus-Interface D-Type Latches with 3-State Outputs									✓		✓			SCBS665

## **ABTE/ETL**

### **Advanced BiCMOS Technology/ Enhanced Transceiver Logic**

ABTE, with wide-noise-margin ETL logic levels on the A port, is backward compatible with existing LVTTTL/TTL logic. ABTE devices support the ANSI/VITA 1-1994 specification (VME64), with tight tolerances for transition times and skew. ABTE is manufactured using the 0.8- $\mu$  BiCMOS process and provides A-port drive levels up to 90 mA for incident-wave switching. B-port features include bus-hold circuitry, eliminating the need for external pullup resistors and 25- $\Omega$  series output resistors to dampen signal reflections. Other features include a  $V_{CC}$  BIAS pin and internal pullup resistors on control pins for live-insertion protection.

The VMEbus International Trade Association (VITA) established a task group in 1997 to specify a synchronous protocol to double data transfer rates to 320 Mbyte/s or more. The new specification, 2eSST (two-edge source synchronous transfer), is based on the asynchronous 2eVME protocol.

Sustained data rates of 1 Gbyte/s, more than ten times faster than traditional VME64 backplanes with single-edge signaling, are possible by taking advantage of the 2eSST use of both edges of each VMEbus clock and the 21-slot VME320 star-configuration backplane.

TI, in conjunction with VITA, is designing a device to support the 2eSST protocol.

See [www.ti.com/sc/logic](http://www.ti.com/sc/logic) for the most current data sheets and additional information on this new device.

# DEVICE SELECTION GUIDE

## ABTE/ETL

DEVICE	NO. PINS	DESCRIPTION	AVAILABILITY			LITERATURE REFERENCE
			MIL	SSOP	TSSOP	
SN74ABTE16245	48	16-Bit Incident-Wave-Switching Bus Transceivers with 3-State Outputs	✓	✓	✓	SCBS226
SN74ABTE16246	48	11-Bit Incident-Wave-Switching Bus Transceivers with 3-State and Open-Collector Outputs		✓	✓	SCBS227

### commercial package description and availability

#### DSBGA (die-size ball grid array)†

YEA, YZA = 5/6/8 pins  
YEP, YZP = 5/6/8 pins

#### LFBGA (low-profile fine-pitch ball grid array)

GGM = 80/100 pins  
GKE, ZKE = 96 pins  
GKF, ZKF = 114 pins

#### VFBGA (very-thin-profile fine-pitch ball grid array)

GQN, ZQN = 20 pins  
GQL, ZQL = 56 pins (also includes 48-pin functions)

#### schedule

✓ = Now    ✚ = Planned

† JEDEC reference for wafer chip scale package (WCSP)

#### PDIP (plastic dual-in-line package)

P = 8 pins  
N = 14/16/20/24 pins  
NT = 24/28 pins

#### PLCC (plastic leaded chip carrier)

FN = 20/28/44/68/84 pins

#### SOIC (small-outline integrated circuit)

D = 8/14/16 pins  
DW = 16/18/20/24/28 pins

#### SOT (small-outline transistor)

PK = 3 pins  
DBV = 3/4/5 pins  
DCY = 4 pins  
DCK = 5/6 pins

#### QFN (quad flatpack no lead)

RGY = 14/16/20 pins  
RGQ = 56 pins

#### QFP (quad flatpack)

RC = 52 pins (FB only)  
PH = 80 pins (FIFOs only)  
PQ = 100/132 pins (FIFOs only)

#### LQFP (low-profile quad flatpack)

PZA = 80 pins

#### TQFP (plastic thin quad flatpack)

PAH = 52 pins  
PAG = 64 pins (FB only)  
PM = 64 pins  
PN = 80 pins  
PCA, PZ = 100 pins (FB only)  
PCB = 120 pins (FIFOs only)

#### SOP (small-outline package)

PS = 8 pins  
NS = 14/16/20/24 pins

#### QSOP (quarter-size small-outline package)

DBQ = 16/20/24 pins

#### SSOP (shrink small-outline package)

DCT = 8 pins  
DB = 14/16/20/24/28/30/38 pins  
DBQ = 16/20/24 pins  
DL = 28/48/56 pins

#### TSSOP (thin shrink small-outline package)

PW = 8/14/16/20/24/28 pins  
DGG = 48/56/64 pins

#### TVSOP (thin very small-outline package)

DGV = 14/16/20/24/48/56 pins  
DBB = 80/100 pins

#### VSSOP (very thin shrink small-outline package)

DCU = 8 pins



## AC/ACT

### Advanced CMOS Logic

TI offers a full family of advanced CMOS logic, with a wide range of AC/ACT devices for low-power and medium- to high-speed applications. Products acquired from Harris Semiconductor provide many additional functions. Over 160 AC and ACT device types are available, including gates, latches, flip-flops, buffers/drivers, counters, multiplexers, transceivers, and registered transceivers. The AC/ACT family is a reliable, low-power logic family, with 24-mA output current drive at 5-V  $V_{CC}$  (AC/ACT) and 12-mA output current drive 3.3-V  $V_{CC}$  (AC only).

The family includes standard end-pin products and center-pin  $V_{CC}$  and ground-configuration products with OEC™ circuitry. The OEC circuitry, available only with the center-pin products, helps reduce simultaneous switching noise associated with high-speed logic. The center-pin products include 16-, 18-, and 20-bit bus-interface functions in the 48- and 56-pin shrink small-outline package (SSOP) and thin shrink small-outline package (TSSOP). These packages allow the designer to double functionality in the same circuit board area or reduce the circuit board area by one-half.

The AC family offers CMOS inputs and outputs, while the ACT family offers TTL inputs with CMOS outputs.

See [www.ti.com/sc/logic](http://www.ti.com/sc/logic) for the most current data sheets.

# DEVICE SELECTION GUIDE

## AC

DEVICE	NO. PINS	DESCRIPTION	AVAILABILITY						LITERATURE REFERENCE
			MIL	PDIP	SOIC	SOP	SSOP	TSSOP	
CD74AC00	14	Quad 2-Input NAND Gates	✓	✓	✓				SCHS223
SN74AC00	14	Quad 2-Input NAND Gates	✓	✓	✓	✓	✓	✓	SCAS524
CD74AC02	14	Quad 2-Input NOR Gates	✓	✓	✓				SCHS224
CD74AC04	14	Hex Inverters	✓	✓	✓				SCHS225
SN74AC04	14	Hex Inverters	✓	✓	✓	✓	✓	✓	SCAS519
CD74AC05	14	Hex Inverters with Open-Drain Outputs	✓	✓	✓				SCHS225
CD74AC08	14	Quad 2-Input AND Gates	✓	✓	✓				SCHS226
SN74AC08	14	Quad 2-Input AND Gates	✓	✓	✓	✓	✓	✓	SCAS536
CD74AC10	14	Triple 3-Input NAND Gates		✓	✓				SCHS227
SN74AC10	14	Triple 3-Input NAND Gates	✓	✓	✓	✓	✓	✓	SCAS529
SN74AC11	14	Triple 3-Input AND Gates	✓	✓	✓	✓	✓	✓	SCAS532
CD74AC14	14	Hex Schmitt-Trigger Inverters		✓	✓				SCHS228
SN74AC14	14	Hex Schmitt-Trigger Inverters	✓	✓	✓	✓	✓	✓	SCAS522
CD74AC20	14	Dual 4-Input NAND Gates	✓	✓	✓				SCHS229
CD74AC32	14	Quad 2-Input OR Gates	✓	✓	✓				SCHS230
SN74AC32	14	Quad 2-Input OR Gates	✓	✓	✓	✓	✓	✓	SCAS528
CD74AC74	14	Dual D-Type Flip-Flops with Set and Reset	✓	✓	✓				SCHS231
SN74AC74	14	Dual D-Type Flip-Flops with Set and Reset	✓	✓	✓	✓	✓	✓	SCAS521
CD74AC86	14	Quad 2-Input Exclusive-OR Gates		✓	✓				SCHS232
SN74AC86	14	Quad 2-Input Exclusive-OR Gates	✓	✓	✓	✓	✓	✓	SCAS533
CD74AC109	16	Dual Positive-Edge-Triggered J-K Flip Flops with Set and Reset	✓	✓	✓				SCHS282
CD74AC112	16	Dual Negative-Edge-Triggered J-K Flip-Flops with Set and Reset	✓	✓	✓				SCHS282
CD74AC138	16	3-to-8 Line Inverting Decoders/Demultiplexers	✓	✓	✓				SCHS234
CD74AC139	16	Dual 2-to-4 Line Decoders/Demultiplexers	✓	✓	✓				SCHS235
CD74AC151	16	1-of-8 Data Selectors/Multiplexers		✓	✓				SCHS236
CD74AC153	16	Dual 1-of-4 Data Selectors/Multiplexers	✓	✓	✓				SCHS237
CD74AC157	16	Quad 2-to-4 Line Data Selectors/Multiplexers	✓	✓	✓				SCHS283
CD74AC158	16	Quad 2-to-4 Line Data Selectors/Multiplexers			✓				SCHS283
CD74AC161	16	Synchronous 4-Bit Binary Counters	✓	✓	✓				SCHS239
CD74AC163	16	Synchronous 4-Bit Binary Counters	✓	✓	✓				SCHS284
CD74AC164	14	8-Bit Serial-In, Parallel-Out Shift Registers	✓	✓	✓				SCHS240
CD74AC174	16	Hex D-Type Flip-Flops with Clear		✓	✓				SCHS241

### commercial package description and availability

#### DSBGA (die-size ball grid array)†

YEA, YZA = 5/6/8 pins  
YEP, YZP = 5/6/8 pins

#### LFBGA (low-profile fine-pitch ball grid array)

GGM = 80/100 pins  
GKE, ZKE = 96 pins  
GKF, ZKF = 114 pins

#### VFBGA (very-thin-profile fine-pitch ball grid array)

GQN, ZQN = 20 pins  
GQL, ZQL = 56 pins (also includes 48-pin functions)

#### schedule

✓ = Now    ✚ = Planned

† JEDEC reference for wafer chip scale package (WCSP)  
See Appendix A for package information  
on CD54/74AC devices.

#### PDIP (plastic dual-in-line package)

P = 8 pins  
N = 14/16/20/24 pins  
NT = 24/28 pins

#### PLCC (plastic leaded chip carrier)

FN = 20/28/44/68/84 pins

#### SOIC (small-outline integrated circuit)

D = 8/14/16 pins  
DW = 16/18/20/24/28 pins

#### SOT (small-outline transistor)

PK = 3 pins  
DBV = 3/4/5 pins  
DCY = 4 pins  
DCK = 5/6 pins

#### QFN (quad flatpack no lead)

RGY = 14/16/20 pins  
RGQ = 56 pins

#### QFP (quad flatpack)

RC = 52 pins (FB only)  
PH = 80 pins (FIFOs only)  
PQ = 100/132 pins (FIFOs only)

#### LQFP (low-profile quad flatpack)

PZA = 80 pins

#### TQFP (plastic thin quad flatpack)

PAH = 52 pins  
PAG = 64 pins (FB only)  
PM = 64 pins  
PN = 80 pins  
PCA, PZ = 100 pins (FB only)  
PCB = 120 pins (FIFOs only)

#### SOP (small-outline package)

PS = 8 pins  
NS = 14/16/20/24 pins

#### QSOP (quarter-size small-outline package)

DBQ = 16/20/24 pins

#### SSOP (shrink small-outline package)

DCT = 8 pins  
DB = 14/16/20/24/28/30/38 pins  
DBQ = 16/20/24 pins  
DL = 28/48/56 pins

#### TSSOP (thin shrink small-outline package)

PW = 8/14/16/20/24/28 pins  
DGG = 48/56/64 pins

#### TVSOP (thin very small-outline package)

DGV = 14/16/20/24/48/56 pins  
DBB = 80/100 pins

#### VSSOP (very thin shrink small-outline package)

DCU = 8 pins





DEVICE	NO. PINS	DESCRIPTION	AVAILABILITY						LITERATURE REFERENCE
			MIL	PDIP	SOIC	SOP	SSOP	TSSOP	
CD74AC175	16	Quad D-Type Flip-Flops with Clear			✓				SCHS242
CD74AC238	16	3-to-8 Line Decoders/Demultiplexers			✓				SCHS234
CD74AC240	20	Octal Buffers/Drivers with 3-State Outputs	✓	✓	✓				SCHS287
SN74AC240	20	Octal Buffers/Drivers with 3-State Outputs	✓	✓	✓	✓	✓	✓	SCAS512
CD74AC241	20	Octal Buffers/Drivers with 3-State Outputs	✓						SCHS287
SN74AC241	20	Octal Buffers/Drivers with 3-State Outputs		✓	✓	✓	✓	✓	SCAS513
CD74AC244	20	Octal Buffers and Line Drivers with 3-State Outputs	✓	✓	✓				SCHS287
SN74AC244	20	Octal Buffers and Line Drivers with 3-State Outputs	✓	✓	✓	✓	✓	✓	SCAS514
CD74AC245	20	Octal Bus Transceivers with 3-State Outputs	✓	✓	✓		✓		SCHS245
SN74AC245	20	Octal Bus Transceivers with 3-State Outputs	✓	✓	✓	✓	✓	✓	SCAS461
CD74AC251	16	1-of-8 Data Selectors/Multiplexers with 3-State Outputs			✓				SCHS246
CD74AC253	16	Dual 1-of-4 Data Selectors/Multiplexers with 3-State Outputs			✓				SCHS247
CD74AC257	16	Quad 1-of-2 Data Selectors/Multiplexers with 3-State Outputs	✓	✓	✓				SCHS248
CD74AC273	20	Octal D-Type Flip-Flops with Clear	✓	✓	✓				SCHS249
CD74AC280	14	9-Bit Odd/Even Parity Generators/Checkers	✓	✓	✓				SCHS250
CD74AC283	16	9-Bit Binary Full Adders with Fast Carry	✓	✓	✓				SCHS251
CD74AC299	20	8-Bit Universal Shift/Storage Registers	✓		✓				SCHS288
CD74AC323	20	8-Bit Universal Shift/Storage Registers			✓				SCHS288
CD74AC373	20	Octal Transparent D-Type Latches with 3-State Outputs	✓	✓	✓				SCHS289
SN74AC373	20	Octal Transparent D-Type Latches with 3-State Outputs	✓	✓	✓	✓	✓	✓	SCAS540
CD74AC374	20	Octal Transparent D-Type Latches with 3-State Outputs	✓	✓	✓				SCHS290
SN74AC374	20	Octal D-Type Edge-Triggered Flip-Flops with 3-State Outputs	✓	✓	✓	✓	✓	✓	SCAS543
SN74AC533	20	Octal Inverting Transparent Latches with 3-State Outputs		✓	✓	✓	✓	✓	SCAS555
CD74AC534	20	Octal D-Type Inverting Flip-Flops with 3-State Outputs			✓				SCHS290
SN74AC534	20	Octal D-Type Inverting Flip-Flops with 3-State Outputs		✓	✓	✓	✓	✓	SCAS554
CD74AC540	20	Inverting Octal Buffers and Line Drivers with 3-State Outputs			✓				SCHS285
CD74AC541	20	Octal Buffers and Line Drivers with 3-State Outputs	✓	✓	✓				SCHS285
CD74AC563	20	Octal Inverting Transparent Latches with 3-State Outputs		✓					SCHS291
SN74AC563	20	Octal Inverting Transparent Latches with 3-State Outputs		✓	✓	✓	✓	✓	SCAS552
SN74AC564	20	Octal D-Type Inverting Flip-Flops with 3-State Outputs		✓	✓	✓	✓	✓	SCAS551
CD74AC573	20	Octal Transparent D-Type Latches with 3-State Outputs	✓	✓	✓				SCHS291
SN74AC573	20	Octal Transparent D-Type Latches with 3-State Outputs		✓	✓	✓	✓	✓	SCAS542
CD74AC574	20	Octal Edge-Triggered D-Type Flip-Flops with 3-State Outputs	✓	✓	✓				SCHS292
SN74AC574	20	Octal Edge-Triggered D-Type Flip-Flops with 3-State Outputs	✓	✓	✓	✓	✓	✓	SCAS541
CD74AC623	20	Octal Bus Transceivers with 3-State Outputs		✓		✓			SCHS286
CD74AC646	24	Octal Registered Bus Transceivers with 3-State Outputs	✓		✓				SCHS293
CD74AC652	24	Octal Bus Transceivers and Registers with 3-State Outputs			✓				SCHS294
74AC11000	16	Quad 2-Input NAND Gates		✓	✓	✓			SCLS054
74AC11004	20	Hex Inverters		✓	✓				SCHS033
74AC11008	16	Quad 2-Input AND Gates		✓	✓			✓	SCAS014
74AC11032	16	Quad 2-Input OR Gates		✓	✓	✓			SCAS007
74AC11074	14	Dual D-Type Flip-Flops with Set and Reset		✓	✓	✓	✓	✓	SCAS499
74AC11086	16	Quad 2-Input Exclusive-OR Gates		✓	✓				SCAS081
74AC11138	16	3-to-8 Line Inverting Decoders/Demultiplexers		✓	✓	✓		✓	SCAS042

# DEVICE SELECTION GUIDE

## AC

DEVICE	NO. PINS	DESCRIPTION	AVAILABILITY						LITERATURE REFERENCE
			MIL	PDIP	SOIC	SOP	SSOP	TSSOP	
74AC11175	20	Quad D-Type Flip-Flops with Clear		✓	✓				SCAS090
74AC11240	24	Octal Buffers/Drivers with 3-State Outputs		✓	✓		✓		SCAS448
74AC11244	24	Octal Buffers and Line Drivers with 3-State Outputs		✓	✓	✓	✓	✓	SCAS171
74AC11245	24	Octal Bus Transceivers with 3-State Outputs		✓	✓				SCAS010
74AC11257	20	Quad 1-of-2 Data Selectors/Multiplexers with 3-State Outputs		✓	✓		✓	✓	SCAS049
74AC16244	48	16-Bit Buffers/Drivers with 3-State Outputs					✓		SCAS120
74AC16245	48	16-Bit Bus Transceivers with 3-State Outputs					✓		SCAS235
74AC16373	48	16-Bit Transparent D-Type Latches with 3-State Outputs					✓		SCAS121
74AC16374	48	16-Bit Edge-Triggered D-Type Flip-Flops with 3-State Outputs					✓		SCAS123
74AC16652	56	16-Bit Bus Transceivers and Registers with 3-State Outputs					✓		SCAS242

DEVICE	NO. PINS	DESCRIPTION	AVAILABILITY						LITERATURE REFERENCE
			MIL	PDIP	SOIC	SOP	SSOP	TSSOP	
CD74ACT00	14	Quad 2-Input NAND Gates	✓	✓	✓				SCHS223
SN74ACT00	14	Quad 2-Input NAND Gates	✓	✓	✓	✓	✓	✓	SCAS523
CD74ACT02	14	Quad 2-Input NOR Gates	✓	✓	✓				SCHS224
CD74ACT04	14	Hex Inverters	✓	✓	✓				SCHS225
SN74ACT04	14	Hex Inverters	✓	✓	✓	✓	✓	✓	SCAS518
CD74ACT05	14	Hex Inverters with Open-Drain Outputs	✓	✓	✓				SCHS225
CD74ACT08	14	Quad 2-Input AND Gates	✓	✓	✓				SCHS226
SN74ACT08	14	Quad 2-Input AND Gates	✓	✓	✓	✓	✓	✓	SCAS535
CD74ACT10	14	Triple 3-Input NAND Gates		✓	✓				SCHS227
SN74ACT10	14	Triple 3-Input NAND Gates	✓	✓	✓	✓	✓	✓	SCAS526
SN74ACT11	14	Triple 3-Input AND Gates	✓	✓	✓	✓	✓	✓	SCAS531
CD74ACT14	14	Hex Schmitt-Trigger Inverters		✓	✓				SCHS228
SN74ACT14	14	Hex Schmitt-Trigger Inverters	✓	✓	✓	✓	✓	✓	SCAS557
CD74ACT20	14	Dual 4-Input NAND Gates	✓	✓	✓				SCHS229
CD74ACT32	14	Quad 2-Input OR Gates	✓	✓	✓				SCHS230
SN74ACT32	14	Quad 2-Input OR Gates	✓	✓	✓	✓	✓	✓	SCAS530
CD74ACT74	14	Dual D-Type Flip-Flops with Set and Reset	✓	✓	✓				SCHS231
SN74ACT74	14	Dual D-Type Flip-Flops with Set and Reset	✓	✓	✓	✓	✓	✓	SCAS520
CD74ACT86	14	Quad 2-Input Exclusive-OR Gates	✓	✓	✓				SCHS232
SN74ACT86	14	Quad 2-Input Exclusive-OR Gates	✓	✓	✓	✓	✓	✓	SCAS534
CD74ACT109	16	Dual Positive-Edge-Triggered J-K Flip Flops with Set and Reset	✓	✓	✓				SCHS233
CD74ACT112	16	Dual Negative-Edge-Triggered J-K Flip-Flops with Set and Reset	✓		✓				SCHS233
CD74ACT138	16	3-to-8 Line Inverting Decoders/Demultiplexers	✓	✓	✓				SCHS234
CD74ACT139	16	Dual 2-to-4 Line Decoders/Demultiplexers	✓	✓	✓				SCHS235
CD74ACT151	16	1-of-8 Data Selectors/Multiplexers	✓		✓				SCHS236
CD74ACT153	16	Dual 1-of-4 Data Selectors/Multiplexers	✓	✓	✓				SCHS237
CD74ACT157	16	Quad 2-to-4 Line Data Selectors/Multiplexers		✓	✓			✓	SCHS283
CD74ACT158	16	Quad 2-to-4 Line Data Selectors/Multiplexers			✓				SCHS238
CD74ACT161	16	Synchronous 4-Bit Binary Counters	✓	✓	✓				SCHS284
CD74ACT163	16	Synchronous 4-Bit Binary Counters	✓	✓	✓				SCHS299
CD74ACT164	14	8-Bit Serial-In, Parallel-Out Shift Registers	✓	✓	✓				SCHS240
CD74ACT174	16	Hex D-Type Flip-Flops with Clear	✓	✓	✓				SCHS241

**commercial package description and availability**

**DSBGA** (die-size ball grid array)†

YEA, YZA = 5/6/8 pins  
YEP, YZP = 5/6/8 pins

**LFBGA** (low-profile fine-pitch ball grid array)

GGM = 80/100 pins  
GKE, ZKE = 96 pins  
GKF, ZKF = 114 pins

**VFBGA** (very-thin-profile fine-pitch ball grid array)

GQN, ZQN = 20 pins  
GQL, ZQL = 56 pins (also includes 48-pin functions)

**schedule**

✓ = Now   ✦ = Planned

† JEDEC reference for wafer chip scale package (WCSP)  
See Appendix A for package information on CD54/74ACT devices.

**PDIP** (plastic dual-in-line package)

P = 8 pins  
N = 14/16/20/24 pins  
NT = 24/28 pins

**PLCC** (plastic leaded chip carrier)

FN = 20/28/44/68/84 pins

**SOIC** (small-outline integrated circuit)

D = 8/14/16 pins  
DW = 16/18/20/24/28 pins

**SOT** (small-outline transistor)

PK = 3 pins  
DBV = 3/4/5 pins  
DCY = 4 pins  
DCK = 5/6 pins

**QFN** (quad flatpack no lead)

RGY = 14/16/20 pins  
RGO = 56 pins

**QFP** (quad flatpack)

RC = 52 pins (FB only)  
PH = 80 pins (FIFOs only)  
PQ = 100/132 pins (FIFOs only)

**LQFP** (low-profile quad flatpack)

PZA = 80 pins

**TQFP** (plastic thin quad flatpack)

PAH = 52 pins  
PAG = 64 pins (FB only)  
PM = 64 pins  
PN = 80 pins  
PCA, PZ = 100 pins (FB only)  
PCB = 120 pins (FIFOs only)

**SOP** (small-outline package)

PS = 8 pins  
NS = 14/16/20/24 pins

**QSOP** (quarter-size small-outline package)

DBQ = 16/20/24 pins

**SSOP** (shrink small-outline package)

DCT = 8 pins  
DB = 14/16/20/24/28/30/38 pins  
DBQ = 16/20/24 pins  
DL = 28/48/56 pins

**TSSOP** (thin shrink small-outline package)

PW = 8/14/16/20/24/28 pins  
DGG = 48/56/64 pins

**TVSOP** (thin very small-outline package)

DGV = 14/16/20/24/48/56 pins  
DBB = 80/100 pins

**VSSOP** (very thin shrink small-outline package)

DCU = 8 pins



# DEVICE SELECTION GUIDE

## ACT

DEVICE	NO. PINS	DESCRIPTION	AVAILABILITY						LITERATURE REFERENCE
			MIL	PDIP	SOIC	SOP	SSOP	TSSOP	
CD74ACT175	16	Quad D-Type Flip-Flops with Clear		✓	✓				SCHS242
CD74ACT238	16	3-to-8 Line Decoders/Demultiplexers		✓					SCHS234
CD74ACT240	20	Octal Buffers/Drivers with 3-State Outputs	✓	✓	✓				SCHS244
SN74ACT240	20	Octal Buffers/Drivers with 3-State Outputs	✓	✓	✓	✓	✓	✓	SCAS515
CD74ACT241	20	Octal Buffers/Drivers with 3-State Outputs	✓	✓	✓				SCHS287
SN74ACT241	20	Octal Buffers/Drivers with 3-State Outputs	✓	✓	✓	✓	✓	✓	SCAS516
CD74ACT244	20	Octal Buffers and Line Drivers with 3-State Outputs	✓	✓	✓				SCHS287
SN74ACT244	20	Octal Buffers and Line Drivers with 3-State Outputs	✓	✓	✓	✓	✓	✓	SCAS517
CD74ACT245	20	Octal Bus Transceivers with 3-State Outputs	✓	✓	✓		✓		SCHS245
SN74ACT245	20	Octal Bus Transceivers with 3-State Outputs	✓	✓	✓	✓	✓	✓	SCAS452
CD74ACT253	16	Dual 1-of-4 Data Selectors/Multiplexers with 3-State Outputs	✓	✓	✓				SCHS247
CD74ACT257	16	Quad 1-of-2 Data Selectors/Multiplexers with 3-State Outputs	✓	✓	✓				SCHS248
CD74ACT258	16	Quad 1-of-2 Data Selectors/Multiplexers with 3-State Outputs			✓				SCHS248
CD74ACT273	20	Octal D-Type Flip-Flops with Clear	✓	✓	✓		✓	✓	SCHS249
CD74ACT280	14	9-Bit Odd/Even Parity Generators/Checkers	✓	✓	✓				SCHS250
CD74ACT283	16	9-Bit Binary Full Adders with Fast Carry	✓	✓	✓				SCHS251
CD74ACT297	16	Digital Phase-Locked Loops			✓				SCHS297
CD74ACT299	20	8-Bit Universal Shift/Storage Registers	✓		✓				SCHS288
CD74ACT373	20	Octal Transparent D-Type Latches with 3-State Outputs	✓	✓	✓				SCHS289
SN74ACT373	20	Octal Transparent D-Type Latches with 3-State Outputs	✓	✓	✓	✓	✓	✓	SCAS544
CD74ACT374	20	Octal Transparent D-Type Latches with 3-State Outputs	✓	✓	✓				SCHS290
SN74ACT374	20	Octal D-Type Edge-Triggered Flip-Flops with 3-State Outputs	✓	✓	✓	✓	✓	✓	SCAS539
SN74ACT533	20	Octal Inverting Transparent Latches with 3-State Outputs	✓	✓	✓	✓	✓	✓	SCAS553
SN74ACT534	20	Octal D-Type Inverting Flip-Flops with 3-State Outputs	✓	✓	✓	✓	✓	✓	SCAS556
CD74ACT540	20	Inverting Octal Buffers and Line Drivers with 3-State Outputs	✓	✓	✓				SCHS285
CD74ACT541	20	Octal Buffers and Line Drivers with 3-State Outputs	✓	✓	✓		✓		SCHS285
SN74ACT563	20	Octal Inverting Transparent Latches with 3-State Outputs		✓	✓	✓	✓	✓	SCAS550
SN74ACT564	20	Octal D-Type Inverting Flip-Flops with 3-State Outputs		✓	✓	✓	✓	✓	SCAS549
CD74ACT573	20	Octal Transparent D-Type Latches with 3-State Outputs	✓	✓	✓				SCHS291
SN74ACT573	20	Octal Transparent D-Type Latches with 3-State Outputs	✓	✓	✓	✓	✓	✓	SCAS538
CD74ACT574	20	Octal Edge-Triggered D-Type Flip-Flops with 3-State Outputs	✓	✓	✓				SCHS292
SN74ACT574	20	Octal Edge-Triggered D-Type Flip-Flops with 3-State Outputs		✓	✓	✓	✓	✓	SCAS537
CD74ACT623	20	Octal Bus Transceivers with 3-State Outputs	✓		✓				SCHS286
CD74ACT646	24	Octal Registered Bus Transceivers with 3-State Outputs		✓	✓				SCHS293
CD74ACT652	24	Octal Bus Transceivers and Registers with 3-State Outputs		✓	✓				SCHS294
SN74ACT1071	14	10-Bit Bus-Termination Networks with Bus Hold			✓				SCAS192
SN74ACT1073	20	16-Bit Bus-Termination Networks with Bus Hold			✓	✓			SCAS193
SN74ACT1284	20	7-Bit Bus Interfaces with 3-State Outputs			✓	✓	✓	✓	SCAS459
74ACT11000	16	Quad 2-Input NAND Gates		✓	✓	✓			SCAS002
74ACT11004	20	Hex Inverters		✓	✓		✓	✓	SCAS215
74ACT11008	16	Quad 2-Input AND Gates		✓	✓	✓		✓	SCAS013
74ACT11030	14	8-Input NAND Gates		✓	✓				SCLS050
74ACT11032	16	Quad 2-Input OR Gates		✓	✓		✓	✓	SCAS008
74ACT11074	14	Dual D-Type Flip-Flops with Set and Reset		✓	✓	✓	✓		SCAS498



DEVICE	NO. PINS	DESCRIPTION	AVAILABILITY					LITERATURE REFERENCE	
			MIL	PDIP	SOIC	SOP	SSOP		TSSOP
74ACT11139	16	Dual 2-to-4 Line Decoders/Demultiplexers			✓			✓	SCAS175
74ACT11240	24	Octal Buffers/Drivers with 3-State Outputs		✓	✓		✓		SCAS210
74ACT11244	24	Octal Buffers and Line Drivers with 3-State Outputs		✓	✓	✓	✓	✓	SCAS006
74ACT11245	24	Octal Bus Transceivers with 3-State Outputs		✓	✓	✓	✓	✓	SCAS031
74ACT11257	20	Quad 1-of-2 Data Selectors/Multiplexers with 3-State Outputs		✓	✓	✓	✓		SCAS053
74ACT11286	14	9-Bit Parity Generators/Checkers with Bus-Driver Parity I/O Port		✓	✓				SCAS069
74ACT11373	24	Octal Transparent D-Type Latches with 3-State Outputs		✓	✓	✓	✓		SCAS015
74ACT11374	24	Octal Transparent D-Type Latches with 3-State Outputs		✓	✓	✓			SCAS217
74ACT11543	28	Octal Registered Transceivers with 3-State Outputs			✓				SCAS136
74ACT11652	28	Octal Bus Transceivers and Registers with 3-State Outputs			✓				SCAS087
74ACT16240	48	16-Bit Buffers/Drivers with 3-State Outputs	✓				✓		SCAS137
74ACT16244	48	16-Bit Buffers/Drivers with 3-State Outputs	✓				✓	✓	SCAS116
74ACT16245	48	16-Bit Bus Transceivers with 3-State Outputs	✓				✓	✓	SCAS097
74ACT16373	48	16-Bit Transparent D-Type Latches with 3-State Outputs	✓				✓		SCAS122
74ACT16374	48	16-Bit Edge-Triggered D-Type Flip-Flops with 3-State Outputs	✓				✓		SCAS124
74ACT16541	48	16-Bit Buffers/Drivers with 3-State Outputs					✓		SCAS208
74ACT16543	56	16-Bit Registered Transceivers with 3-State Outputs					✓	✓	SCAS126
74ACT16623	48	16-Bit Bus Transceivers with 3-State Outputs					✓		SCAS152
74ACT16646	56	16-Bit Bus Transceivers and Registers with 3-State Outputs					✓		SCAS127
74ACT16651	56	16-Bit Bus Transceivers and Registers with 3-State Outputs					✓		SCAS449
74ACT16652	56	16-Bit Bus Transceivers and Registers with 3-State Outputs					✓		SCAS128
74ACT16657	56	16-Bit Transceivers with Parity Generators/Checkers and 3-State Outputs					✓		SCAS164
74ACT16823	56	18-Bit D-Type Flip-Flops with 3-State Outputs					✓		SCAS160
74ACT16825	56	18-Bit Buffers/Drivers with 3-State Outputs					✓		SCAS155
74ACT16827	56	20-Bit Buffers/Drivers with 3-State Outputs					✓		SCAS163
74ACT16841	56	20-Bit Bus-Interface D-Type Latches with 3-State Outputs					✓		SCAS174
74ACT16861	56	20-Bit Bus Transceivers with 3-State Outputs					✓		SCAS197
74ACT16863	56	18-Bit Bus-Interface Transceivers with 3-State Outputs					✓		SCAS162
74ACT16952	56	16-Bit Registered Transceivers with 3-State Outputs					✓		SCAS159

# AHC/AHCT

## Advanced High-Speed CMOS Logic

The AHC/AHCT logic family provides a natural migration path for HCMOS users who need more speed in low-power, low-noise, and low-drive applications. The AHC logic family consists of basic gates, octals, and 16-bit Widebus™ functions. TI also offers single-gate solutions, designated with 1G in the device name.

Performance characteristics of the AHC family are:

- Speed – Typical propagation delays of 5.2 ns (octals), about three times faster than HC devices. At 5-V  $V_{CC}$ , AHC devices are the quick and quiet solution for higher-speed operation.
- Low noise – The AHC family allows designers to combine the low-noise characteristics of HCMOS devices with today's performance levels, without the overshoot and undershoot problems typical of higher-drive devices required to get AHC speeds.
- Low power – The AHC family CMOS technology exhibits low power consumption (40-mA max static current, one-half that of HCMOS).
- Drive – Output-drive current is  $\pm 8$  mA at 5-V  $V_{CC}$  (AHC/AHCT) and  $\pm 4$  mA at 3.3-V  $V_{CC}$  (AHC only).
- The AHC family offers CMOS inputs and outputs, while the AHCT family offers TTL inputs with CMOS outputs.
- Packaging – AHC devices are available in small-outline integrated circuit (SOIC), small-outline package (SOP), shrink small-outline package (SSOP), plastic dual in-line package (PDIP), thin shrink small-outline package (TSSOP), thin very small-outline package (TVSOP), and 5-pin small-outline transistor (SOT) package. Selected AHC devices are available in military versions (SN54AHCxx).

Using TI products offers several business advantages:

- Competitive advantage – AHC and competitors' VHC devices have equivalent specifications; therefore, AHC devices are drop-in replacements offering alternate sources. With TI's production capacity, delivery performance, and competitive prices, AHC devices are among the most economical, easy-to-use, and readily available logic products.

See [www.ti.com/sc/logic](http://www.ti.com/sc/logic) for the most current data sheets.

# DEVICE SELECTION GUIDE

## AHC

DEVICE	NO. PINS	DESCRIPTION	AVAILABILITY							LITERATURE REFERENCE		
			MIL	PDIP	QFN	SOIC	SOP	SOT	SSOP		TSSOP	TVSOP
SN74AHC1G00	5	Single 2-Input NAND Gates						✓				SCLS313
SN74AHC1G02	5	Single 2-Input NOR Gates						✓				SCLS342
SN74AHC1G04	5	Single Inverters						✓				SCLS318
SN74AHC1GU04	5	Single Inverters						✓				SCLS343
SN74AHC1G08	5	Single 2-Input AND Gates						✓				SCLS314
SN74AHC1G14	5	Single Schmitt-Trigger Inverters						✓				SCLS321
SN74AHC1G32	5	Single 2-Input OR Gates						✓				SCLS317
SN74AHC1G86	5	Single 2-Input Exclusive-OR Gates						✓				SCLS323
SN74AHC1G125	5	Single Bus Buffers with 3-State Outputs						✓				SCLS377
SN74AHC1G126	5	Single Bus Buffers with 3-State Outputs						✓				SCLS379
SN74AHC00	14	Quad 2-Input NAND Gates	✓	✓	✓	✓	✓		✓	✓	✓	SCLS227
SN74AHC02	14	Quad 2-Input NOR Gates	✓	✓	✓	✓	✓		✓	✓	✓	SCLS254
SN74AHC04	14	Hex Inverters	✓	✓	✓	✓	✓		✓	✓	✓	SCLS231
SN74AHC04	14	Hex Unbuffered Inverters	✓	✓	✓	✓	✓		✓	✓	✓	SCLS234
SN74AHC05	14	Hex Inverters with Open-Drain Outputs		✓		✓			✓	✓	✓	SCLS357
SN74AHC08	14	Quad 2-Input AND Gates	✓	✓	✓	✓	✓		✓	✓	✓	SCLS236
SN74AHC14	14	Hex Schmitt-Trigger Inverters	✓	✓	✓	✓	✓		✓	✓	✓	SCLS238
SN74AHC32	14	Quad 2-Input OR Gates	✓	✓	✓	✓	✓		✓	✓	✓	SCLS247
SN74AHC74	14	Dual D-Type Flip-Flops with Set and Reset	✓	✓	✓	✓	✓		✓	✓	✓	SCLS255
SN74AHC86	14	Quad 2-Input Exclusive-OR Gates	✓	✓	✓	✓	✓		✓	✓	✓	SCLS249
SN74AHC123A	16	Dual Retriggerable Monostable Multivibrators with Reset	✓	✓		✓			✓	✓	✓	SCLS352
SN74AHC125	14	Quad Bus Buffers with 3-State Outputs	✓	✓	✓	✓	✓		✓	✓	✓	SCLS256
SN74AHC126	14	Quad Bus Buffers with 3-State Outputs	✓	✓		✓	✓		✓	✓	✓	SCLS257
SN74AHC132	14	Quad 2-Input NAND Gates with Schmitt-Trigger Inputs		✓	✓	✓	✓		✓	✓	✓	SCLS365
SN74AHC138	16	3-to-8 Line Inverting Decoders/Demultiplexers	✓	✓	✓	✓	✓		✓	✓	✓	SCLS258
SN74AHC139	16	Dual 2-to-4 Line Decoders/Demultiplexers		✓	✓	✓	✓		✓	✓	✓	SCLS259
SN74AHC157	16	Quad 2-to-4 Line Data Selectors/Multiplexers	✓	✓	✓	✓	✓		✓	✓	✓	SCLS345
SN74AHC158	16	Quad 2-to-4 Line Data Selectors/Multiplexers		✓		✓	✓		✓	✓	✓	SCLS346
SN74AHC174	16	Hex D-Type Flip-Flops with Clear	✓	✓		✓	✓		✓	✓	✓	SCLS425
SN74AHC240	20	Octal Buffers/Drivers with 3-State Outputs	✓	✓		✓	✓		✓	✓	✓	SCLS251
SN74AHC244	20	Octal Buffers and Line Drivers with 3-State Outputs	✓	✓		✓	✓		✓	✓	✓	SCLS226

### commercial package description and availability

#### DSBGA (die-size ball grid array)†

YEA, YZA = 5/6/8 pins  
YEP, YZP = 5/6/8 pins

#### LFBGA (low-profile fine-pitch ball grid array)

GGM = 80/100 pins  
GKE, ZKE = 96 pins  
GKF, ZKF = 114 pins

#### VFBGA (very-thin-profile fine-pitch ball grid array)

GQN, ZQN = 20 pins  
GQL, ZQL = 56 pins (also includes 48-pin functions)

#### schedule

✓ = Now    ✚ = Planned

#### PDIP (plastic dual-in-line package)

P = 8 pins  
N = 14/16/20/24 pins  
NT = 24/28 pins

#### PLCC (plastic leaded chip carrier)

FN = 20/28/44/68/84 pins

#### SOIC (small-outline integrated circuit)

D = 8/14/16 pins  
DW = 16/18/20/24/28 pins

#### SOT (small-outline transistor)

PK = 3 pins  
DBV = 3/4/5 pins  
DCY = 4 pins  
DCK = 5/6 pins

#### QFN (quad flatpack no lead)

RGY = 14/16/20 pins  
RGQ = 56 pins

#### QFP (quad flatpack)

RC = 52 pins (FB only)  
PH = 80 pins (FIFOs only)  
PQ = 100/132 pins (FIFOs only)

#### LQFP (low-profile quad flatpack)

PZA = 80 pins

#### TQFP (plastic thin quad flatpack)

PAH = 52 pins  
PAG = 64 pins (FB only)  
PM = 64 pins  
PN = 80 pins  
PCA, PZ = 100 pins (FB only)  
PCB = 120 pins (FIFOs only)

#### SOP (small-outline package)

PS = 8 pins  
NS = 14/16/20/24 pins

#### QSOP (quarter-size small-outline package)

DBQ = 16/20/24 pins

#### SSOP (shrink small-outline package)

DCT = 8 pins  
DB = 14/16/20/24/28/30/38 pins  
DBQ = 16/20/24 pins  
DL = 28/48/56 pins

#### TSSOP (thin shrink small-outline package)

PW = 8/14/16/20/24/28 pins  
DGG = 48/56/64 pins

#### TVSOP (thin very small-outline package)

DGV = 14/16/20/24/48/56 pins  
DBB = 80/100 pins

#### VSSOP (very thin shrink small-outline package)

DCU = 8 pins

† JEDEC reference for wafer chip scale package (WCSP)



DEVICE	NO. PINS	DESCRIPTION	AVAILABILITY							LITERATURE REFERENCE		
			MIL	PDIP	QFN	SOIC	SOP	SOT	SSOP		TSSOP	TVSOP
SN74AHC245	20	Octal Bus Transceivers with 3-State Outputs	✓	✓		✓	✓		✓	✓	✓	SCLS230
SN74AHC273	20	Octal D-Type Flip-Flops with Clear	✓	✓		✓			✓	✓	✓	SCLS376
SN74AHC367	16	Hex Buffers/Line Drivers with 3-State Outputs	✓	✓		✓			✓	✓	✓	SCLS424
SN74AHC373	20	Octal Transparent D-Type Latches with 3-State Outputs	✓	✓		✓	✓		✓	✓	✓	SCLS235
SN74AHC374	20	Octal D-Type Edge-Triggered Flip-Flops with 3-State Outputs	✓	✓		✓	✓		✓	✓	✓	SCLS240
SN74AHC540	20	Inverting Octal Buffers and Line Drivers with 3-State Outputs	✓	✓		✓	✓		✓	✓	✓	SCLS260
SN74AHC541	20	Octal Buffers and Line Drivers with 3-State Outputs	✓	✓		✓	✓		✓	✓	✓	SCLS261
SN74AHC573	20	Octal Transparent D-Type Latches with 3-State Outputs	✓	✓		✓	✓		✓	✓	✓	SCLS242
SN74AHC574	20	Octal Edge-Triggered D-Type Flip-Flops with 3-State Outputs	✓	✓		✓	✓		✓	✓	✓	SCLS244
SN74AHC594	16	8-Bit Shift Registers with Output Registers		✓		✓	✓		✓	✓		SCLS423
SN74AHC595	16	8-Bit Shift Registers with 3-State Output Registers		✓		✓	✓		✓	✓		SCLS373
SN74AHC16240	48	16-Bit Buffers/Drivers with 3-State Outputs							✓	✓	✓	SCLS326
SN74AHC16244	48	16-Bit Buffers/Drivers with 3-State Outputs							✓	✓	✓	SCLS327
SN74AHC16373	48	16-Bit Transparent D-Type Latches with 3-State Outputs							✓	✓	✓	SCLS329
SN74AHC16374	48	16-Bit Edge-Triggered D-Type Flip-Flops with 3-State Outputs							✓	✓	✓	SCLS330
SN74AHC16540	48	16-Bit Buffers/Drivers with 3-State Outputs							✓	✓	✓	SCLS331
SN74AHC16541	48	16-Bit Buffers/Drivers with 3-State Outputs							✓	✓	✓	SCLS332



# DEVICE SELECTION GUIDE

## AHCT

DEVICE	NO. PINS	DESCRIPTION	AVAILABILITY							LITERATURE REFERENCE		
			MIL	PDIP	QFN	SOIC	SOP	SOT	SSOP		TSSOP	TVSOP
SN74AHCT1G00	5	Single 2-Input NAND Gates						✓				SCLS316
SN74AHCT1G02	5	Single 2-Input NOR Gates						✓				SCLS341
SN74AHCT1G04	5	Single Inverters						✓				SCLS319
SN74AHCT1G08	5	Single 2-Input AND Gates						✓				SCLS315
SN74AHCT1G14	5	Single Schmitt-Trigger Inverters						✓				SCLS322
SN74AHCT1G32	5	Single 2-Input OR Gates						✓				SCLS320
SN74AHCT1G86	5	Single 2-Input Exclusive-OR Gates						✓				SCLS324
SN74AHCT1G125	5	Single Bus Buffers with 3-State Outputs						✓				SCLS378
SN74AHCT1G126	5	Single Bus Buffers with 3-State Outputs						✓				SCLS380
SN74AHCT00	14	Quad 2-Input NAND Gates	✓	✓	✓	✓	✓		✓	✓	✓	SCLS229
SN74AHCT02	14	Quad 2-Input NOR Gates	✓	✓	✓	✓	✓		✓	✓	✓	SCLS262
SN74AHCT04	14	Hex Inverters	✓	✓	✓	✓	✓		✓	✓	✓	SCLS232
SN74AHCT08	14	Quad 2-Input AND Gates	✓	✓	✓	✓	✓		✓	✓	✓	SCLS237
SN74AHCT14	14	Hex Schmitt-Trigger Inverters	✓	✓	✓	✓	✓		✓	✓	✓	SCLS246
SN74AHCT32	14	Quad 2-Input OR Gates	✓	✓	✓	✓	✓		✓	✓	✓	SCLS248
SN74AHCT74	14	Dual D-Type Flip-Flops with Set and Reset	✓	✓	✓	✓	✓		✓	✓	✓	SCLS263
SN74AHCT86	14	Quad 2-Input Exclusive-OR Gates	✓	✓	✓	✓	✓		✓	✓	✓	SCLS250
SN74AHCT123A	16	Dual Retriggerable Monostable Multivibrators with Reset	✓	✓		✓			✓	✓	✓	SCLS420
SN74AHCT125	14	Quad Bus Buffers with 3-State Outputs	✓	✓	✓	✓	✓		✓	✓	✓	SCLS264
SN74AHCT126	14	Quad Bus Buffers with 3-State Outputs	✓	✓	✓	✓	✓		✓	✓	✓	SCLS265
SN74AHCT132	14	Quad 2-Input NAND Gates with Schmitt-Trigger Inputs		✓		✓	✓		✓	✓	✓	SCLS366
SN74AHCT138	16	3-to-8 Line Inverting Decoders/Demultiplexers	✓	✓		✓	✓		✓	✓	✓	SCLS266
SN74AHCT139	16	Dual 2-to-4 Line Decoders/Demultiplexers	✓	✓		✓	✓		✓	✓	✓	SCLS267
SN74AHCT157	16	Quad 2-to-4 Line Data Selectors/Multiplexers		✓		✓	✓		✓	✓	✓	SCLS347
SN74AHCT158	16	Quad 2-to-4 Line Data Selectors/Multiplexers		✓		✓	✓		✓	✓	✓	SCLS348
SN74AHCT174	16	Hex D-Type Flip-Flops with Clear	✓	✓		✓	✓		✓	✓	✓	SCLS419
SN74AHCT240	20	Octal Buffers/Drivers with 3-State Outputs	✓	✓		✓	✓		✓	✓		SCLS252
SN74AHCT244	20	Octal Buffers and Line Drivers with 3-State Outputs	✓	✓		✓	✓		✓	✓	✓	SCLS228
SN74AHCT245	20	Octal Bus Transceivers with 3-State Outputs	✓	✓		✓	✓		✓	✓	✓	SCLS233
SN74AHCT273	20	Octal D-Type Flip-Flops with Clear		✓		✓	✓		✓	✓	✓	SCLS375
SN74AHCT367	16	Hex Buffers/Line Drivers with 3-State Outputs		✓		✓	✓		✓	✓	✓	SCLS418

### commercial package description and availability

#### DSBGA (die-size ball grid array)†

YEA, YZA = 5/6/8 pins  
YEP, YZP = 5/6/8 pins

#### LFBGA (low-profile fine-pitch ball grid array)

GGM = 80/100 pins  
GKE, ZKE = 96 pins  
GKF, ZKF = 114 pins

#### VFBGA (very-thin-profile fine-pitch ball grid array)

GQN, ZQN = 20 pins  
GQL, ZQL = 56 pins (also includes 48-pin functions)

#### schedule

✓ = Now    ✚ = Planned

#### PDIP (plastic dual-in-line package)

P = 8 pins  
N = 14/16/20/24 pins  
NT = 24/28 pins

#### PLCC (plastic leaded chip carrier)

FN = 20/28/44/68/84 pins

#### SOIC (small-outline integrated circuit)

D = 8/14/16 pins  
DW = 16/18/20/24/28 pins

#### SOT (small-outline transistor)

PK = 3 pins  
DBV = 3/4/5 pins  
DCY = 4 pins  
DCK = 5/6 pins

#### QFN (quad flatpack no lead)

RGY = 14/16/20 pins  
RGQ = 56 pins

#### QFP (quad flatpack)

RC = 52 pins (FB only)  
PH = 80 pins (FIFOs only)  
PQ = 100/132 pins (FIFOs only)

#### LQFP (low-profile quad flatpack)

PZA = 80 pins

#### TQFP (plastic thin quad flatpack)

PAH = 52 pins  
PAG = 64 pins (FB only)  
PM = 64 pins  
PN = 80 pins  
PCA, PZ = 100 pins (FB only)  
PCB = 120 pins (FIFOs only)

#### SOP (small-outline package)

PS = 8 pins  
NS = 14/16/20/24 pins

#### QSOP (quarter-size small-outline package)

DBQ = 16/20/24 pins

#### SSOP (shrink small-outline package)

DCT = 8 pins  
DB = 14/16/20/24/28/30/38 pins  
DBQ = 16/20/24 pins  
DL = 28/48/56 pins

#### TSSOP (thin shrink small-outline package)

PW = 8/14/16/20/24/28 pins  
DGG = 48/56/64 pins

#### TVSOP (thin very small-outline package)

DGV = 14/16/20/24/48/56 pins  
DBB = 80/100 pins

#### VSSOP (very thin shrink small-outline package)

DCU = 8 pins

† JEDEC reference for wafer chip scale package (WCSP)



DEVICE	NO. PINS	DESCRIPTION	AVAILABILITY							LITERATURE REFERENCE		
			MIL	PDIP	QFN	SOIC	SOP	SOT	SSOP		TSSOP	TVSOP
SN74AHCT373	20	Octal Transparent D-Type Latches with 3-State Outputs	✓	✓		✓	✓		✓	✓		SCLS139
SN74AHCT374	20	Octal D-Type Edge-Triggered Flip-Flops with 3-State Outputs	✓	✓		✓	✓		✓	✓	✓	SCLS241
SN74AHCT540	20	Inverting Octal Buffers and Line Drivers with 3-State Outputs	✓	✓		✓	✓		✓	✓	✓	SCLS268
SN74AHCT541	20	Octal Buffers and Line Drivers with 3-State Outputs	✓	✓		✓	✓		✓	✓		SCLS269
SN74AHCT573	20	Octal Transparent D-Type Latches with 3-State Outputs	✓	✓		✓	✓			✓	✓	SCLS243
SN74AHCT574	20	Octal Edge-Triggered D-Type Flip-Flops with 3-State Outputs	✓	✓		✓	✓		✓	✓	✓	SCLS245
SN74AHCT594	16	8-Bit Shift Registers with Output Registers		✓		✓	✓		✓	✓		SCLS417
SN74AHCT595	16	8-Bit Shift Registers with 3-State Output Registers		✓		✓	✓		✓	✓		SCLS374
SN74AHCT16240	48	16-Bit Buffers/Drivers with 3-State Outputs							✓	✓	✓	SCLS333
SN74AHCT16244	48	16-Bit Buffers/Drivers with 3-State Outputs							✓	✓	✓	SCLS334
SN74AHCT16245	48	16-Bit Bus Transceivers with 3-State Outputs							✓	✓	✓	SCLS335
SN74AHCT16373	48	16-Bit Transparent D-Type Latches with 3-State Outputs							✓	✓	✓	SCLS336
SN74AHCT16374	48	16-Bit Edge-Triggered D-Type Flip-Flops with 3-State Outputs							✓	✓	✓	SCLS337
SN74AHCT16540	48	16-Bit Buffers/Drivers with 3-State Outputs							✓	✓	✓	SCLS338
SN74AHCT16541	48	16-Bit Buffers/Drivers with 3-State Outputs							✓	✓	✓	SCLS339

## **ALB**

### **Advanced Low-Voltage BiCMOS Logic**

The specially designed 3.3-V ALB family uses 0.6- $\mu$  BiCMOS process technology for bus-interface functions. ALB provides 25-mA drive at 3.3 V with maximum propagation delays of 2.2 ns, making it one of TI's fastest logic families. The inputs have clamping diodes to limit overshoot and undershoot.

The ALB family currently is available in two functions with Widebus™ and Shrink Widebus™ footprints, with advanced packaging options such as shrink small-outline package (SSOP), thin shrink small-outline package (TSSOP), and thin very small-outline package (TVSOP).

See [www.ti.com/sc/logic](http://www.ti.com/sc/logic) for the most current data sheets.

# DEVICE SELECTION GUIDE

## ALB

DEVICE	NO. PINS	DESCRIPTION	AVAILABILITY			LITERATURE REFERENCE
			SSOP	TSSOP	TVSOP	
SN74ALB16244	48	16-Bit Buffers/Drivers with 3-State Outputs	✓	✓	✓	SCBS647
SN74ALB16245	48	16-Bit Bus Transceivers with 3-State Outputs	✓	✓	✓	SCBS678

### commercial package description and availability

#### DSBGA (die-size ball grid array)†

YEA, YZA = 5/6/8 pins  
YEP, YZP = 5/6/8 pins

#### LFBGA (low-profile fine-pitch ball grid array)

GGM = 80/100 pins  
GKE, ZKE = 96 pins  
GKF, ZKF = 114 pins

#### VFBGA (very-thin-profile fine-pitch ball grid array)

GQN, ZQN = 20 pins  
GQL, ZQL = 56 pins (also includes 48-pin functions)

#### schedule

✓ = Now    ✚ = Planned

† JEDEC reference for wafer chip scale package (WCSP)

#### PDIP (plastic dual-in-line package)

P = 8 pins  
N = 14/16/20/24 pins  
NT = 24/28 pins

#### PLCC (plastic leaded chip carrier)

FN = 20/28/44/68/84 pins

#### SOIC (small-outline integrated circuit)

D = 8/14/16 pins  
DW = 16/18/20/24/28 pins

#### SOT (small-outline transistor)

PK = 3 pins  
DBV = 3/4/5 pins  
DCY = 4 pins  
DCK = 5/6 pins

#### QFN (quad flatpack no lead)

RGY = 14/16/20 pins  
RGQ = 56 pins

#### QFP (quad flatpack)

RC = 52 pins (FB only)  
PH = 80 pins (FIFOs only)  
PQ = 100/132 pins (FIFOs only)

#### LQFP (low-profile quad flatpack)

PZA = 80 pins

#### TQFP (plastic thin quad flatpack)

PAH = 52 pins  
PAG = 64 pins (FB only)  
PM = 64 pins  
PN = 80 pins  
PCA, PZ = 100 pins (FB only)  
PCB = 120 pins (FIFOs only)

#### SOP (small-outline package)

PS = 8 pins  
NS = 14/16/20/24 pins

#### QSOP (quarter-size small-outline package)

DBQ = 16/20/24 pins

#### SSOP (shrink small-outline package)

DCT = 8 pins  
DB = 14/16/20/24/28/30/38 pins  
DBQ = 16/20/24 pins  
DL = 28/48/56 pins

#### TSSOP (thin shrink small-outline package)

PW = 8/14/16/20/24/28 pins  
DGG = 48/56/64 pins

#### TVSOP (thin very small-outline package)

DGV = 14/16/20/24/48/56 pins  
DBB = 80/100 pins

#### VSSOP (very thin shrink small-outline package)

DCU = 8 pins



## **ALS**

### **Advanced Low-Power Schottky Logic**

The ALS family provides over 140 bipolar logic functions.

This family, combined with the AS family, can be used to optimize systems through performance budgeting. By using AS in speed-critical paths and ALS where speed is less critical, designers can optimize speed and power performance in bipolar designs.

The ALS family includes gates, flip-flops, counters, drivers, transceivers, registered transceivers, readback latches, clock drivers, register files, and multiplexers.

See [www.ti.com/sc/logic](http://www.ti.com/sc/logic) for the most current data sheets.

# DEVICE SELECTION GUIDE

## ALS

DEVICE	NO. PINS	DESCRIPTION	AVAILABILITY					LITERATURE REFERENCE
			MIL	PDIP	SOIC	SOP	SSOP	
SN74ALS00A	14	Quad 2-Input NAND Gates	✓	✓	✓	✓	✓	SDAS187
SN74ALS02A	14	Quad 2-Input NOR Gates	✓	✓	✓	✓		SDAS111
SN74ALS03B	14	Quad 2-Input NAND Gates with Open-Collector Outputs	✓	✓	✓			SDAS013
SN74ALS04B	14	Hex Inverters	✓	✓	✓	✓	✓	SDAS063
SN74ALS05A	14	Hex Inverters with Open-Collector Outputs	✓	✓	✓	✓	✓	SDAS190
SN74ALS08	14	Quad 2-Input AND Gates	✓	✓	✓	✓		SDAS191
SN74ALS09	14	Quad 2-Input AND Gates with Open-Collector Outputs	✓	✓	✓	✓		SDAS084
SN74ALS10A	14	Triple 3-Input NAND Gates	✓	✓	✓	✓		SDAS002
SN74ALS11A	14	Triple 3-Input AND Gates	✓	✓	✓	✓		SDAS009
SN74ALS20A	14	Dual 4-Input NAND Gates	✓	✓	✓	✓	✓	SDAS192
SN74ALS21A	14	Dual 4-Input AND Gates	✓	✓	✓	✓		SDAS085
SN74ALS27A	14	Triple 3-Input NOR Gates	✓	✓	✓	✓		SDAS112
SN74ALS30A	14	8-Input NAND Gates	✓	✓	✓	✓		SDAS010
SN74ALS32	14	Quad 2-Input OR Gates	✓	✓	✓	✓		SDAS113
SN74ALS33A	14	Quad 2-Input NOR Gates	✓	✓	✓			SDAS034
SN74ALS35A	14	Hex Noninverters with Open-Collector Outputs		✓	✓			SDAS011
SN74ALS37A	14	Quad 2-Input NAND Gates	✓	✓	✓	✓		SDAS195
SN74ALS38B	14	Quad 2-Input NAND Gates	✓	✓	✓	✓		SDAS196
SN74ALS74A	14	Dual D-Type Flip-Flops with Set and Reset	✓	✓	✓	✓		SDAS143
SN74ALS86	14	Quad 2-Input Exclusive-OR Gate	✓	✓	✓	✓		SDAS006
SN74ALS109A	16	Dual Positive-Edge-Triggered J-K Flip Flops with Set and Reset	✓	✓	✓	✓		SDAS198
SN74ALS112A	16	Dual Negative-Edge-Triggered J-K Flip-Flops with Set and Reset	✓	✓	✓	✓		SDAS199
SN74ALS133	16	13-Input NAND Gates	✓	✓	✓	✓		SDAS202
SN74ALS137A	16	3-to-8 Line Decoders/Demultiplexers with Address Latches	✓	✓	✓	✓		SDAS203
SN74ALS138A	16	3-to-8 Line Inverting Decoders/Demultiplexers	✓	✓	✓	✓		SDAS055
SN74ALS139	16	Dual 2-to-4 Line Decoders/Demultiplexers	✓	✓	✓	✓		SDAS204
SN74ALS151	16	1-of-8 Data Selectors/Multiplexers	✓	✓	✓	✓		SDAS205
SN74ALS153	16	Dual 1-of-4 Data Selectors/Multiplexers	✓	✓	✓	✓		SDAS206
SN74ALS156	16	Dual 2-to-4 Line Decoders/Demultiplexers with Open-Collector Outputs		✓	✓			SDAS099
SN74ALS157A	16	Quad 2-to-4 Line Data Selectors/Multiplexers	✓	✓	✓	✓		SDAS081
SN74ALS158	16	Quad 2-to-4 Line Data Selectors/Multiplexers	✓	✓	✓	✓		SDAS081
SN74ALS161B	16	Synchronous 4-Bit Binary Counters	✓	✓	✓	✓		SDAS024

### commercial package description and availability

#### DSBGA (die-size ball grid array)†

YEA, YZA = 5/6/8 pins  
YEP, YZP = 5/6/8 pins

#### LFBGA (low-profile fine-pitch ball grid array)

GGM = 80/100 pins  
GKE, ZKE = 96 pins  
GKF, ZKF = 114 pins

#### VFBGA (very-thin-profile fine-pitch ball grid array)

GQN, ZQN = 20 pins  
GQL, ZQL = 56 pins (also includes 48-pin functions)

#### schedule

✓ = Now    ✚ = Planned

#### PDIP (plastic dual-in-line package)

P = 8 pins  
N = 14/16/20/24 pins  
NT = 24/28 pins

#### PLCC (plastic leaded chip carrier)

FN = 20/28/44/68/84 pins

#### SOIC (small-outline integrated circuit)

D = 8/14/16 pins  
DW = 16/18/20/24/28 pins

#### SOT (small-outline transistor)

PK = 3 pins  
DBV = 3/4/5 pins  
DCY = 4 pins  
DCK = 5/6 pins

#### QFN (quad flatpack no lead)

RGY = 14/16/20 pins  
RGQ = 56 pins

#### QFP (quad flatpack)

RC = 52 pins (FB only)  
PH = 80 pins (FIFOs only)  
PQ = 100/132 pins (FIFOs only)

#### LQFP (low-profile quad flatpack)

PZA = 80 pins

#### TQFP (plastic thin quad flatpack)

PAH = 52 pins  
PAG = 64 pins (FB only)  
PM = 64 pins  
PN = 80 pins  
PCA, PZ = 100 pins (FB only)  
PCB = 120 pins (FIFOs only)

#### SOP (small-outline package)

PS = 8 pins  
NS = 14/16/20/24 pins

#### QSOP (quarter-size small-outline package)

DBQ = 16/20/24 pins

#### SSOP (shrink small-outline package)

DCT = 8 pins  
DB = 14/16/20/24/28/30/38 pins  
DBQ = 16/20/24 pins  
DL = 28/48/56 pins

#### TSSOP (thin shrink small-outline package)

PW = 8/14/16/20/24/28 pins  
DGG = 48/56/64 pins

#### TVSOP (thin very small-outline package)

DGV = 14/16/20/24/48/56 pins  
DBB = 80/100 pins

#### VSSOP (very thin shrink small-outline package)

DCU = 8 pins

† JEDEC reference for wafer chip scale package (WCSP)



DEVICE	NO. PINS	DESCRIPTION	AVAILABILITY					LITERATURE REFERENCE
			MIL	PDIP	SOIC	SOP	SSOP	
SN74ALS163B	16	Synchronous 4-Bit Binary Counters	✓	✓	✓	✓	✓	SDAS024
SN74ALS164A	14	8-Bit Serial-In, Parallel-Out Shift Registers		✓	✓	✓		SDAS159
SN74ALS165	16	8-Bit Parallel-In, Serial-Out Shift Registers	✓	✓	✓			SDAS157
SN74ALS166	16	8-Bit Parallel-Load Shift Registers		✓	✓	✓	✓	SDAS156
SN74ALS169B	16	Synchronous 4-Bit Up/Down Binary Counters	✓	✓	✓	✓		SDAS125
SN74ALS174	16	Hex D-Type Flip-Flops with Clear	✓	✓	✓	✓		SDAS207
SN74ALS175	16	Quad D-Type Flip-Flops with Clear	✓	✓	✓	✓		SDAS207
SN74ALS191A	16	Presetable Synchronous 4-Bit Up/Down Binary Counters	✓	✓	✓	✓		SDAS210
SN54ALS193	16	Presetable Synchronous 4-Bit Up/Down Binary Counters	✓					Call
SN74ALS193A	16	Presetable Synchronous 4-Bit Up/Down Binary Counters	✓	✓	✓	✓		SDAS211
SN74ALS240A	20	Octal Buffers/Drivers with 3-State Outputs	✓	✓	✓	✓	✓	SDAS214
SN74ALS240A-1	20	Octal Buffers/Drivers with 3-State Outputs		✓	✓	✓	✓	SDAS214
SN74ALS241C	20	Octal Buffers/Drivers with 3-State Outputs	✓	✓	✓	✓		SDAS153
SN74ALS243A	14	Quad Bus Transceivers with 3-State Outputs	✓	✓	✓	✓		SDAS069
SN74ALS244C	20	Octal Buffers and Line Drivers with 3-State Outputs	✓	✓	✓	✓	✓	SDAS142
SN74ALS244C-1	20	Octal Buffers and Line Drivers with 3-State Outputs		✓	✓	✓		SDAS142
SN74ALS245A	20	Octal Bus Transceivers with 3-State Outputs	✓	✓	✓	✓	✓	SDAS272
SN74ALS245A-1	20	Octal Bus Transceivers with 3-State Outputs		✓	✓	✓		SDAS272
SN74ALS251	16	1-of-8 Data Selectors/Multiplexers with 3-State Outputs	✓	✓	✓	✓		SDAS215
SN74ALS253	16	Dual 1-of-4 Data Selectors/Multiplexers with 3-State Outputs	✓	✓	✓	✓		SDAS216
SN74ALS257	16	Quad 1-of-2 Data Selectors/Multiplexers with 3-State Outputs	✓					SDAS124
SN74ALS257A	16	Quad 1-of-2 Data Selectors/Multiplexers with 3-State Outputs		✓	✓	✓		SDAS124
SN74ALS258	16	Quad 1-of-2 Data Selectors/Multiplexers with 3-State Outputs	✓					SDAS124
SN74ALS258A	16	Quad 1-of-2 Data Selectors/Multiplexers with 3-State Outputs		✓	✓	✓		SDAS124
SN74ALS259	16	8-Bit Addressable Latches	✓	✓	✓			SDAS217
SN74ALS273	20	Octal D-Type Flip-Flops with Clear	✓	✓	✓	✓		SDAS218
SN74ALS280	14	9-Bit Odd/Even Parity Generators/Checkers		✓	✓			SDAS038
SN74ALS299	20	8-Bit Universal Shift/Storage Registers	✓	✓	✓			SDAS220
SN74ALS323	20	8-Bit Universal Shift/Storage Registers	✓	✓	✓	✓		SDAS267
SN74ALS373	20	Octal Transparent D-Type Latches with 3-State Outputs	✓					SDAS083
SN74ALS373A	20	Octal Transparent D-Type Latches with 3-State Outputs		✓	✓	✓	✓	SDAS083
SN74ALS374A	20	Octal D-Type Edge-Triggered Flip-Flops with 3-State Outputs	✓	✓	✓	✓	✓	SDAS167
SN74ALS518	20	8-Bit Identity Comparators (P = Q) with Open-Collector Outputs and Input Pullup Resistors		✓	✓	✓		SDAS224
SN74ALS520	20	8-Bit Identity Comparators (P = Q) with Input Pullup Resistors	✓	✓	✓	✓		SDAS224
SN74ALS521	20	8-Bit Identity Comparators (P = Q)		✓	✓	✓		SDAS224
SN74ALS533A	20	Octal Inverting Transparent Latches with 3-State Outputs		✓	✓	✓		SDAS270
SN74ALS534A	20	Octal D-Type Inverting Flip-Flops with 3-State Outputs	✓	✓	✓	✓		SDAS168
SN74ALS540	20	Inverting Octal Buffers and Line Drivers with 3-State Outputs		✓	✓	✓		SDAS025
SN74ALS540-1	20	Inverting Octal Buffers and Line Drivers with 3-State Outputs		✓	✓	✓	✓	SDAS025
SN74ALS541	20	Octal Buffers and Line Drivers with 3-State Outputs	✓	✓	✓	✓	✓	SDAS025
SN74ALS541-1	20	Octal Buffers and Line Drivers with 3-State Outputs		✓	✓			SDAS025
SN74ALS561A	20	Octal Bus Transceivers and Registers with 3-State Outputs	✓	✓	✓	✓		SDAS225
SN74ALS563B	20	Octal Inverting Transparent Latches with 3-State Outputs	✓	✓	✓	✓		SDAS163

# DEVICE SELECTION GUIDE

## ALS

DEVICE	NO. PINS	DESCRIPTION	AVAILABILITY					LITERATURE REFERENCE
			MIL	PDIP	SOIC	SOP	SSOP	
SN74ALS564B	20	Octal D-Type Inverting Flip-Flops with 3-State Outputs	✓	✓	✓	✓		SDAS164
SN74ALS569A	20	Synchronous 4-Bit Binary Counters with 3-State Outputs	✓	✓	✓	✓		SDAS229
SN74ALS573C	20	Octal Transparent D-Type Latches with 3-State Outputs	✓	✓	✓	✓	✓	SDAS048
SN74ALS574B	20	Octal Edge-Triggered D-Type Flip-Flops with 3-State Outputs	✓	✓	✓	✓		SDAS165
SN74ALS575A	24	Octal Edge-Triggered D-Type Flip-Flops with 3-State Outputs		✓	✓			SDAS165
SN74ALS576B	20	Octal Edge-Triggered D-Type Flip-Flops with 3-State Outputs	✓	✓	✓	✓		SDAS065
SN74ALS577A	24	Octal Edge-Triggered D-Type Flip-Flops with 3-State Outputs		✓	✓	✓		SDAS065
SN74ALS580B	20	Octal D-Type Transparent Latches with 3-State Outputs	✓	✓	✓	✓		SDAS277
SN74ALS620A	20	Octal Bus Transceivers with 3-State Outputs		✓	✓			SDAS226
SN74ALS621A	20	Octal Bus Transceivers with Open-Collector Outputs		✓	✓			SDAS226
SN74ALS621A-1	20	Octal Bus Transceivers with Open-Collector Outputs		✓	✓	✓		SDAS226
SN74ALS623A	20	Octal Bus Transceivers with 3-State Outputs		✓	✓	✓		SDAS226
SN74ALS638A	20	Octal Bus Transceivers with 3-State Outputs		✓	✓	✓		SDAS123
SN74ALS638A-1	20	Octal Bus Transceivers with 3-State Outputs		✓	✓	✓		SDAS123
SN74ALS639A	20	Octal Bus Transceivers with 3-State Outputs		✓	✓	✓		SDAS123
SN74ALS640B	20	Octal Bus Transceivers with 3-State Outputs	✓	✓	✓	✓		SDAS122
SN74ALS640B-1	20	Octal Bus Transceivers with 3-State Outputs		✓	✓	✓		SDAS122
SN74ALS641A	20	Octal Bus Transceivers with Open-Collector Outputs		✓	✓	✓		SDAS300
SN74ALS641A-1	20	Octal Bus Transceivers with Open-Collector Outputs		✓	✓	✓		SDAS300
SN74ALS642A	20	Octal Bus Transceivers with Open-Collector Outputs		✓	✓			SDAS300
SN74ALS642A-1	20	Octal Bus Transceivers with Open-Collector Outputs		✓	✓	✓		SDAS300
SN74ALS645A	20	Octal Bus Transceivers with 3-State Outputs	✓	✓	✓	✓		SDAS278
SN74ALS645A-1	20	Octal Bus Transceivers with 3-State Outputs		✓	✓	✓		SDAS278
SN74ALS648A	24	Octal Registered Bus Transceivers with 3-State Outputs	✓	✓	✓			SDAS039
SN74ALS653	24	Octal Bus Transceivers and Registers with Open-Collector and 3-State Outputs		✓	✓			SDAS066
SN74ALS654	24	Octal Bus Transceivers and Registers with Open-Collector and 3-State Outputs		✓	✓			SDAS066
SN74ALS666	24	8-Bit D-Type Transparent Read-Back Latches with 3-State Outputs		✓	✓	✓		SDAS227
SN74ALS667	24	8-Bit D-Type Transparent Read-Back Latches with 3-State Outputs		✓	✓	✓		SDAS227
SN74ALS679	20	12-Bit Address Comparators		✓	✓	✓		SDAS003
SN74ALS688	20	8-Bit Magnitude Comparators	✓	✓	✓	✓		SDAS228
SN74ALS746	20	Octal Buffers and Line Drivers with Input Pullup Resistors and 3-State Outputs		✓	✓			SDAS052
SN74ALS760	20	Octal Buffers and Line Drivers with Open-Collector Outputs		✓	✓			SDAS141
SN74ALS804A	20	Hex 2-Input NAND Drivers	✓	✓	✓			SDAS022
SN74ALS805A	20	Hex 2-Input NOR Drivers	✓	✓	✓			SDAS023
SN74ALS832A	20	Hex 2-Input OR Drivers	✓	✓	✓			SDAS017
SN74ALS841	24	10-Bit Bus-Interface D-Type Latches with 3-State Outputs		✓	✓			SDAS059
SN74ALS843	24	9-Bit Bus-Interface D-Type Latches with 3-State Outputs		✓	✓			SDAS232
SN74ALS845	24	8-Bit Bus-Interface D-Type Latches with 3-State Outputs		✓	✓			SDAS233
SN74ALS857	24	Hex 2-to-1 Universal Multiplexers with 3-State Outputs	✓	✓	✓			SDAS170
SN74ALS867A	24	Synchronous 8-Bit Up/Down Counters		✓	✓			SDAS115
SN74ALS869	24	Synchronous 8-Bit Up/Down Counters		✓	✓			SDAS115
SN74ALS870	24	Dual 16-by-4 Register Files		✓	✓	✓		SDAS139
SN74ALS873B	24	Dual 4-Bit D-Type Latches with 3-State Outputs	✓	✓	✓			SDAS036
SN74ALS874B	24	Dual 4-Bit Edge-Triggered D-Type Flip-Flops with 3-State Outputs	✓	✓	✓	✓		SDAS061



DEVICE	NO. PINS	DESCRIPTION	AVAILABILITY					LITERATURE REFERENCE
			MIL	PDIP	SOIC	SOP	SSOP	
SN74ALS876A	24	Dual 4-Bit Edge-Triggered D-Type Flip-Flops with 3-State Outputs		✓	✓			SDAS061
SN74ALS990	20	8-Bit D-Type Transparent Read-Back Latches		✓	✓			SDAS027
SN74ALS992	24	9-Bit D-Type Transparent Read-Back Latches with 3-State Outputs		✓	✓			SDAS028
SN74ALS994	24	10-Bit D-Type Transparent Read-Back Latches		✓	✓			SDAS237
SN74ALS996	24	8-Bit Edge-Triggered Read-Back Latches	✓	✓	✓			SDAS098
SN74ALS996-1	24	8-Bit Edge-Triggered Read-Back Latches		✓	✓			SDAS098
SN74ALS1004	14	Hex Inverting Drivers		✓	✓	✓		SDAS074
SN74ALS1005	14	Hex Inverting Buffers with Open-Collector Outputs	✓	✓	✓	✓		SDAS240
SN74ALS1034	14	Hex Drivers	✓	✓	✓	✓		SDAS053
SN74ALS1035	14	Hex Noninverting Buffers with Open-Collector Outputs	✓	✓	✓	✓		SDAS243
SN74ALS1244A	20	Octal Buffers and Line Drivers with 3-State Outputs	✓	✓	✓			SDAS186
SN74ALS1245A	20	Octal Bus Transceivers with 3-State Outputs	✓	✓	✓	✓		SDAS245
SN74ALS1640A	20	Octal Bus Transceivers with 3-State Outputs		✓				SDAS246
SN74ALS1645A	20	Octal Bus Transceivers with 3-State Outputs	✓	✓	✓	✓		SDAS246
SN74ALS2240	20	Octal Buffers and Line/MOS Drivers with 3-State Outputs and Series Damping Resistors	✓	✓	✓			SDAS268
SN74ALS2541	20	Octal Line Drivers/MOS Drivers with 3-State Outputs	✓	✓	✓			SDAS273
SN74ALS29821	24	10-Bit Bus-Interface Flip-Flops with 3-State Outputs	✓	✓	✓			SDAS145
SN74ALS29823	24	9-Bit Bus-Interface Flip-Flops with 3-State Outputs	✓	✓	✓			SDAS146
SN74ALS29827	24	10-Bit Buffers/Drivers with 3-State Outputs		✓	✓			SDAS095
SN74ALS29828	24	10-Bit Buffers/Drivers with 3-State Outputs		✓	✓			SDAS095
SN74ALS29833	24	8-Bit to 9-Bit Parity Bus Transceivers		✓	✓			SDAS119
SN74ALS29854	24	8-Bit to 9-Bit Parity Bus Transceivers		✓	✓			SDAS118
SN74ALS29863	24	9-Bit Bus Transceivers with 3-State Outputs		✓	✓			SDAS096

## **ALVC**

### **Advanced Low-Voltage CMOS Technology Logic**

One of the highest-performance 3.3-V bus-interface families is the ALVC family. These specially designed 3-V products are processed in 0.6- $\mu$  CMOS technology, with typical propagation delays of less than 3 ns, current drive of 24 mA, and static current of 40  $\mu$ A for bus-interface functions. ALVC devices have input bus-hold cells to eliminate the need for external pullup resistors for floating inputs. With over 90 Widebus™ and Widebus+™ devices with series damping resistors and gates and octals on the roadmap, ALVC quickly is becoming the industry standard for many 3.3-V logic applications. The family also features innovative functions that make it ideal for memory interleaving, multiplexing, and interfacing to SDRAMs.

Selected devices in the ALVC family are offered in Widebus footprints with all of the advanced packaging, such as shrink small-outline package (SSOP) and thin shrink small-outline package (TSSOP).

Selected ALVC devices are offered in MicroStar BGA™ (LFBGA) and MicroStar Jr.™ (VFBGA) packages. Other devices are offered in the plastic dual-in-line package (PDIP), quad flatpack no-lead (QFN) package, small-outline integrated circuit (SOIC) package, small-outline package (SOP), SSOP, TSSOP, and thin very small-outline package (TVSOP).

See [www.ti.com/sc/logic](http://www.ti.com/sc/logic) for the most current data sheets.

# DEVICE SELECTION GUIDE

## ALVC

DEVICE	NO. PINS	DESCRIPTION	AVAILABILITY							LITERATURE REFERENCE	
			LFBGA	PDIP	QFN	SOIC	SOP	SSOP	TSSOP		TVSOP
<b>Gates and Octals</b>											
SN74ALVC00	14	Quad 2-Input NAND Gates				✓	✓		✓	✓	SCES115
SN74ALVC04	14	Hex Inverters			✓	✓	✓		✓	✓	SCES117
SN74ALVC08	14	Quad 2-Input AND Gates			✓	✓	✓		✓	✓	SCES101
SN74ALVC10	14	Triple 3-Input NAND Gates				✓	✓		✓	✓	SCES106
SN74ALVC14	14	Hex Schmitt-Trigger Inverters				✓		✓	✓	✓	SCES107
SN74ALVC32	14	Quad 2-Input OR Gates				✓			✓	✓	SCES108
SN74ALVC125	14	Quad Bus Buffers with 3-State Outputs				✓	✓		✓	✓	SCES110
SN74ALVC126	14	Quad Bus Buffers with 3-State Outputs				✓	✓		✓	✓	SCES111
SN74ALVC244	20	Octal Buffers and Line Drivers with 3-State Outputs				✓	✓		✓	✓	SCES188
SN74ALVCH244	20	Octal Buffers and Line Drivers with 3-State Outputs				✓	✓		✓	✓	SCES112
SN74ALVC245	20	Octal Bus Transceivers with 3-State Outputs				✓	✓		✓	✓	SCES271
SN74ALVCH245	20	Octal Bus Transceivers with 3-State Outputs				✓	✓		✓	✓	SCES119
SN74ALVCH373	20	Octal Transparent D-Type Latches with 3-State Outputs				✓			✓	✓	SCES116
SN74ALVCH374	20	Octal Edge-Triggered D-Type Flip-Flops with 3-State Outputs		✓		✓		✓	✓	✓	SCES118
<b>Widebus™ Devices</b>											
SN74ALVCH16240	48	16-Bit Buffers/Drivers with 3-State Outputs							✓	✓	SCES045
SN74ALVC16244A	48	16-Bit Buffers/Drivers with 3-State Outputs							✓	✓	SCAS250
SN74ALVCH16244	48	16-Bit Buffers/Drivers with 3-State Outputs							✓	✓	SCES014
SN74ALVCH16245	48	16-Bit Bus Transceivers with 3-State Outputs							✓	✓	SCAS015
SN74ALVCHR16245	48	16-Bit Bus Transceivers with 3-State Outputs							✓	✓	SCES064
SN74ALVCH16260	56	12-Bit to 24-Bit Multiplexed D-Type Latches with 3-State Outputs							✓	✓	SCES046
SN74ALVCH16269	56	12-Bit to 24-Bit Registered Bus Exchangers with 3-State Outputs							✓	✓	SCES019

### commercial package description and availability

#### DSBGA (die-size ball grid array)†

YEA, YZA = 5/6/8 pins  
YEP, YZP = 5/6/8 pins

#### LFBGA (low-profile fine-pitch ball grid array)

GGM = 80/100 pins  
GKE, ZKE = 96 pins  
GKF, ZKF = 114 pins

#### VFBGA (very-thin-profile fine-pitch ball grid array)

GQN, ZQN = 20 pins  
GQL, ZQL = 56 pins (also includes 48-pin functions)

#### schedule

✓ = Now    ✚ = Planned

#### PDIP (plastic dual-in-line package)

P = 8 pins  
N = 14/16/20/24 pins  
NT = 24/28 pins

#### PLCC (plastic leaded chip carrier)

FN = 20/28/44/68/84 pins

#### SOIC (small-outline integrated circuit)

D = 8/14/16 pins  
DW = 16/18/20/24/28 pins

#### SOT (small-outline transistor)

PK = 3 pins  
DBV = 3/4/5 pins  
DCY = 4 pins  
DCK = 5/6 pins

#### QFN (quad flatpack no lead)

RGY = 14/16/20 pins  
RGQ = 56 pins

#### QFP (quad flatpack)

RC = 52 pins (FB only)  
PH = 80 pins (FIFOs only)  
PQ = 100/132 pins (FIFOs only)

#### LQFP (low-profile quad flatpack)

PZA = 80 pins

#### TQFP (plastic thin quad flatpack)

PAH = 52 pins  
PAG = 64 pins (FB only)  
PM = 64 pins  
PN = 80 pins  
PCA, PZ = 100 pins (FB only)  
PCB = 120 pins (FIFOs only)

#### SOP (small-outline package)

PS = 8 pins  
NS = 14/16/20/24 pins

#### QSOP (quarter-size small-outline package)

DBQ = 16/20/24 pins

#### SSOP (shrink small-outline package)

DCT = 8 pins  
DB = 14/16/20/24/28/30/38 pins  
DBQ = 16/20/24 pins  
DL = 28/48/56 pins

#### TSSOP (thin shrink small-outline package)

PW = 8/14/16/20/24/28 pins  
DGG = 48/56/64 pins

#### TVSOP (thin very small-outline package)

DGV = 14/16/20/24/48/56 pins  
DBB = 80/100 pins

#### VSSOP (very thin shrink small-outline package)

DCU = 8 pins

† JEDEC reference for wafer chip scale package (WCSP)



DEVICE	NO. PINS	DESCRIPTION	AVAILABILITY							LITERATURE REFERENCE		
			LFBGA	PDIP	QFN	SOIC	SOP	SSOP	TSSOP		TVSOP	VFBGA
SN74ALVCHR16269A	56	12-Bit to 24-Bit Registered Bus Exchangers with 3-State Outputs						✓	✓	✓		SCES050
SN74ALVCH16270	56	12-Bit to 24-Bit Registered Bus Exchangers with 3-State Outputs						✓	✓			SCES028
SN74ALVCH16271	56	12-Bit to 24-Bit Multiplexed Bus Exchangers with 3-State Outputs						✓	✓			SCES017
SN74ALVCH16282	80	18-Bit to 36-Bit Registered Bus Exchangers with 3-State Outputs									✓	SCES036
SN74ALVC16334	48	16-Bit Universal Bus Drivers with 3-State Outputs						✓	✓	✓		SCES128
SN74ALVCH16334	48	16-Bit Universal Bus Drivers with 3-State Outputs						✓	✓	✓		SCES090
SN74ALVCH16344	56	1-Bit to 4-Bit Address Drivers with 3-State Outputs						✓	✓			SCES054
SN74ALVCH16373	48	16-Bit Transparent D-Type Latches with 3-State Outputs						✓	✓		✓	SCES020
SN74ALVCH16374	48	16-Bit Edge-Triggered D-Type Flip-Flops with 3-State Outputs						✓	✓		✓	SCES021
SN74ALVCH16409	56	9-Bit 4-Port Universal Bus Exchangers with 3-State Outputs						✓	✓			SCES022
SN74ALVCHR16409	56	9-Bit 4-Port Universal Bus Exchangers with 3-State Outputs						✓	✓			SCES056
SN74ALVCH16500	56	18-Bit Universal Bus Transceivers with 3-State Outputs						✓	✓			SCES023
SN74ALVCH16501	56	18-Bit Universal Bus Transceivers with 3-State Outputs						✓	✓		✓	SCES024
SN74ALVCH16524	56	18-Bit Registered Bus Transceivers with 3-State Outputs						✓	✓			SCES080
SN74ALVCH16525	56	18-Bit Registered Bus Transceivers with 3-State Outputs						✓	✓			SCES059
SN74ALVCH16543	56	16-Bit Registered Transceivers with 3-State Outputs						✓	✓			SCES025
SN74ALVCH16600	56	18-Bit Universal Bus Transceivers with 3-State Outputs						✓	✓			SCES030
SN74ALVCH16601	56	18-Bit Universal Bus Transceivers with 3-State Outputs						✓	✓			SCES027
SN74ALVCHR16601	56	18-Bit Universal Bus Transceivers with 3-State Outputs						✓	✓			SCES123
SN74ALVCH16646	56	16-Bit Bus Transceivers and Registers with 3-State Outputs						✓	✓	✓		SCES032
SN74ALVCH16721	56	20-Bit D-Type Flip-Flops with 3-State Outputs						✓	✓	✓		SCES052
SN74ALVCH16820	56	10-Bit D-Type Flip-Flops with Dual Outputs and 3-State Outputs						✓	✓			SCES035
SN74ALVCH16821	56	20-Bit D-Type Flip-Flops with 3-State Outputs						✓	✓			SCES037
SN74ALVCH16823	56	18-Bit D-Type Flip-Flops with 3-State Outputs						✓	✓			SCES038
SN74ALVCH16825	56	18-Bit Buffers/Drivers with 3-State Outputs						✓	✓			SCES039

# DEVICE SELECTION GUIDE

## ALVC

DEVICE	NO. PINS	DESCRIPTION	AVAILABILITY								LITERATURE REFERENCE	
			LFBGA	PDIP	QFN	SOIC	SOP	SSOP	TSSOP	TVSOP		VFBGA
SN74ALVCH16827	56	20-Bit Buffers/Drivers with 3-State Outputs						✓	✓			SCES041
SN74ALVCH16831	80	1-to-4 Address Registers/Drivers with 3-State Outputs									✓	SCES083
SN74ALVCH16832	64	1-to-4 Address Registers/Drivers with 3-State Outputs							✓			SCES098
SN74ALVC16834	56	18-Bit Universal Bus Drivers with 3-State Outputs						✓	✓	✓	✓	SCES140
SN74ALVC16835	56	18-Bit Universal Bus Drivers with 3-State Outputs						✓	✓	✓	✓	SCES125
SN74ALVCH16835	56	18-Bit Universal Bus Drivers with 3-State Outputs						✓	✓	✓	✓	SCES053
SN74ALVCH16841	56	20-Bit Bus-Interface D-Type Latches with 3-State Outputs						✓	✓			SCES043
SN74ALVCH16863	56	18-Bit Bus-Interface Transceivers with 3-State Outputs						✓	✓			SCES060
SN74ALVCH16901	64	18-Bit Universal Bus Transceivers with Parity Generators/Checkers							✓			SCES010
SN74ALVCH16903	56	12-Bit Universal Bus Drivers with Parity Checker and Dual 3-State Outputs						✓	✓	✓		SCES095
SN74ALVCH16952	56	16-Bit Registered Transceivers with 3-State Outputs						✓	✓	✓		SCES011
SN74ALVCH16973	48	8-Bit Bus Transceivers and Transparent D-Type Latches with Four Independent Buffers						✓	✓	✓		SCES435
<b>Widebus+™ Devices</b>												
SN74ALVCH32244	96	32-Bit Buffers/Drivers with 3-State Outputs	✓									SCES281
SN74ALVCH32245	96	32-Bit Bus Transceivers with 3-State Outputs	✓									SCES282
SN74ALVCH32374	96	32-Bit Edge-Triggered D-Type Flip-Flops with 3-State Outputs	✓									SCES283
SN74ALVCH32501	114	32-Bit Universal Bus Transceivers with 3-State Outputs	✓									SCES144
SN74ALVCH32973	96	16-Bit Bus Transceivers and Transparent D-Type Latches with Eight Independent Buffers	✓									SCES436
<b>Widebus™ Devices With Series Damping Resistors</b>												
SN74ALVCH162244	48	16-Bit Buffers/Drivers with Series Damping Resistors and 3-State Outputs						✓	✓			SCES065
SN74ALVCH162260	56	12-Bit to 24-Bit Multiplexed D-Type Latches with Series Damping Resistors and 3-State Outputs						✓	✓			SCES570
SN74ALVCH162268	56	12-Bit to 24-Bit Registered Bus Exchangers with 3-State Outputs						✓	✓		✓	SCES018
SN74ALVCHG162280	80	16-Bit to 32-Bit Bus Exchangers with Byte Masks and 3-State Outputs									✓	SCES093
SN74ALVCHG162282	80	18-Bit to 36-Bit Registered Bus Exchangers with 3-State Outputs									✓	SCES094



DEVICE	NO. PINS	DESCRIPTION	AVAILABILITY							LITERATURE REFERENCE		
			LFBGA	PDIP	QFN	SOIC	SOP	SSOP	TSSOP		TVSOP	VFBGA
SN74ALVC162334	48	16-Bit Universal Bus Drivers with 3-State Outputs						✓	✓	✓		SCES127
SN74ALVCH162334	48	16-Bit Universal Bus Drivers with 3-State Outputs						✓	✓	✓		SCES120
SN74ALVCH162344	56	1-Bit to 4-Bit Address Drivers with 3-State Outputs						✓	✓	✓		SCES085
SN74ALVCH162374	48	16-Bit Edge-Triggered D-Type Flip-Flops with 3-State Outputs						✓	✓			SCES092
SN74ALVCH162409	56	9-Bit 4-Port Universal Bus Exchangers with 3-State Outputs						✓				SCES189
SN74ALVCH162525	56	18-Bit Registered Transceivers with 3-State Outputs						✓	✓			SCES058
SN74ALVCH162601	56	18-Bit Universal Bus Transceivers with 3-State Outputs						✓	✓			SCES026
SN74ALVCH162721	56	20-Bit Flip-Flops with 3-State Outputs						✓	✓			SCES055
SN74ALVCH162820	56	10-Bit Flip-Flops with Dual Outputs and 3-State Outputs						✓	✓			SCES012
SN74ALVCH162827	56	20-Bit Buffers/Drivers with Series Damping Resistors and 3-State Outputs						✓	✓	✓		SCES013
SN74ALVCH162830	80	1-Bit to 2-Bit Address Drivers with 3-State Outputs								✓		SCES082
SN74ALVCHS162830	80	1-Bit to 2-Bit Address Drivers with 3-State Outputs								✓		SCES097
SN74ALVC162831	80	1-Bit to 4-Bit Address Registers/Drivers with 3-State Outputs								✓		SCES605
SN74ALVCH162831	80	1-Bit to 4-Bit Address Registers/Drivers with 3-State Outputs								✓		SCES084
SN74ALVCH162832	64	1-Bit to 4-Bit Address Registers/Drivers with 3-State Outputs							✓			SCES588
SN74ALVC162834	56	18-Bit Universal Bus Drivers with 3-State Outputs						✓	✓	✓		SCES172
SN74ALVCF162834	56	18-Bit Universal Bus Drivers with 3-State Outputs						✓	✓	✓		SCES409
SN74ALVC162835	56	18-Bit Universal Bus Drivers with 3-State Outputs						✓	✓	✓		SCES126
SN74ALVCF162835	56	18-Bit Universal Bus Drivers with 3-State Outputs						✓	✓	✓		SCES397
SN74ALVCH162835	56	18-Bit Universal Bus Drivers with 3-State Outputs						✓	✓	✓		SCES121
SN74ALVC162836	56	20-Bit Universal Bus Drivers with 3-State Outputs						✓	✓	✓		SCES129
SN74ALVCH162836	56	20-Bit Universal Bus Drivers with 3-State Outputs						✓	✓	✓		SCES122
SN74ALVCH162841	56	20-Bit Bus-Interface D-Type Latches with 3-State Outputs						✓	✓			SCES088
<b>Widebus™ Devices With Level Shifter</b>												
SN74ALVC164245	48	16-Bit 3.3-V to-5-V Level-Shifting Transceivers with 3-State Outputs						✓	✓			SCES416

## ALVT

### Advanced Low-Voltage BiCMOS Technology Logic

ALVT is a 5-V-tolerant, 3.3-V and 2.5-V product using 0.6- $\mu$  BiCMOS technology for advanced bus-interface functions. ALVT provides superior performance, up to 28% speed improvement compared to similar LVT at 3.3 V, current drive of 64 mA, and pin-for-pin compatibility with existing ABT and LVT families.

ALVT operates at LVTTTL signal levels in telecom and networking high-performance system point-to-point or distributed-load backplane applications. ALVT is an excellent migration path from ABT or LVT.

Performance characteristics of the ALVT family include:

- 3.3-V or 2.5-V operation, with 5-V-tolerant I/O capability for use in a mixed-voltage environment
- Speed – Provides high performance, with up to 28% speed improvement over LVT
- Drive – Provides up to 64 mA of drive at 3.3-V  $V_{CC}$  and 24 mA at 2.5-V  $V_{CC}$ , yet consumes less than 330  $\mu$ W of standby power

Additional features include:

- Live insertion – ALVT devices incorporate  $I_{off}$  and power-up 3-state (PU3S) circuitry to protect the devices in live-insertion applications and make them ideally suited for hot-insertion applications.  $I_{off}$  prevents the devices from being damaged during partial power down, and PU3S forces the outputs to the high-impedance state during power up and power down.
- Bus hold – Eliminates floating inputs by holding them at the last valid logic state, eliminating the need for external pullup and pulldown resistors
- Damping-resistor option – TI implements series damping resistors on selected devices, reducing overshoot and undershoot, matching line impedance, and minimizing ringing.
- Packaging – ALVT devices are available in shrink small-outline package (SSOP), thin shrink small-outline package (TSSOP), and thin very small-outline package (TVSOP), with selected devices offered in MicroStar BGA™ (LFBGA) and MicroStar Jr.™ (VFBGA) packages.

See [www.ti.com/sc/logic](http://www.ti.com/sc/logic) for the most current data sheets.

# DEVICE SELECTION GUIDE

## ALVT

DEVICE	NO. PINS	DESCRIPTION	AVAILABILITY					LITERATURE REFERENCE
			LFBGA	SSOP	TSSOP	TVSOP	VFBGA	
SN74ALVTH16240	48	16-Bit Buffers/Drivers with 3-State Outputs		✓	✓	✓		SCES138
SN74ALVTH16244	48	16-Bit Buffers/Drivers with 3-State Outputs		✓	✓	✓	✓	SCES070
SN74ALVTH16245	48	16-Bit Bus Transceivers with 3-State Outputs		✓	✓	✓		SCES066
SN74ALVTHR16245	48	2.5-V/3.3-V 16-Bit Bus Transceivers with 3-State Outputs		✓	✓	✓		SCES075
SN74ALVTH16373	48	16-Bit Transparent D-Type Latches with 3-State Outputs		✓	✓	✓	✓	SCES067
SN74ALVTH16374	48	16-Bit Edge-Triggered D-Type Flip-Flops with 3-State Outputs		✓	✓	✓	✓	SCES068
SN74ALVTH16601	56	18-Bit Universal Bus Transceivers with 3-State Outputs		✓	✓	✓		SCES143
SN74ALVTH16821	56	20-Bit D-Type Flip-Flops with 3-State Outputs		✓	✓	✓		SCES078
SN74ALVTH16827	56	20-Bit Buffers/Drivers with 3-State Outputs		✓	✓	✓		SCES076
SN74ALVTH32244	96	32-Bit Buffers/Drivers with 3-State Outputs	✓					SCES279
SN74ALVTH32373	96	32-Bit Transparent D-Type Latches with 3-State Outputs	✓					SCES322
SN74ALVTH32374	96	32-Bit Edge-Triggered D-Type Flip-Flops with 3-State Outputs	✓					SCES280
SN74ALVTH162244	48	16-Bit Buffers/Drivers with Series Damping Resistors and 3-State Outputs		✓	✓	✓		SCES074
SN74ALVTH162245	48	16-Bit Bus Transceivers with 3-State Outputs		✓	✓	✓		SCES331
SN74ALVTH162827	56	20-Bit Buffers/Drivers with Series Damping Resistors and 3-State Outputs		✓	✓	✓		SCES079

### commercial package description and availability

#### DSBGA (die-size ball grid array)†

YEA, YZA = 5/6/8 pins  
YEP, YZP = 5/6/8 pins

#### LFBGA (low-profile fine-pitch ball grid array)

GGM = 80/100 pins  
GKE, ZKE = 96 pins  
GKF, ZKF = 114 pins

#### VFBGA (very-thin-profile fine-pitch ball grid array)

GQN, ZQN = 20 pins  
GQL, ZQL = 56 pins (also includes 48-pin functions)

#### schedule

✓ = Now    ✚ = Planned

#### PDIP (plastic dual-in-line package)

P = 8 pins  
N = 14/16/20/24 pins  
NT = 24/28 pins

#### PLCC (plastic leaded chip carrier)

FN = 20/28/44/68/84 pins

#### SOIC (small-outline integrated circuit)

D = 8/14/16 pins  
DW = 16/18/20/24/28 pins

#### SOT (small-outline transistor)

PK = 3 pins  
DBV = 3/4/5 pins  
DCY = 4 pins  
DCK = 5/6 pins

#### QFN (quad flatpack no lead)

RGY = 14/16/20 pins  
RGQ = 56 pins

#### QFP (quad flatpack)

RC = 52 pins (FB only)  
PH = 80 pins (FIFOs only)  
PQ = 100/132 pins (FIFOs only)

#### LQFP (low-profile quad flatpack)

PZA = 80 pins

#### TQFP (plastic thin quad flatpack)

PAH = 52 pins  
PAG = 64 pins (FB only)  
PM = 64 pins  
PN = 80 pins  
PCA, PZ = 100 pins (FB only)  
PCB = 120 pins (FIFOs only)

#### SOP (small-outline package)

PS = 8 pins  
NS = 14/16/20/24 pins

#### QSOP (quarter-size small-outline package)

DBQ = 16/20/24 pins

#### SSOP (shrink small-outline package)

DCT = 8 pins  
DB = 14/16/20/24/28/30/38 pins  
DBQ = 16/20/24 pins  
DL = 28/48/56 pins

#### TSSOP (thin shrink small-outline package)

PW = 8/14/16/20/24/28 pins  
DGG = 48/56/64 pins

#### TVSOP (thin very small-outline package)

DGV = 14/16/20/24/48/56 pins  
DBB = 80/100 pins

#### VSSOP (very thin shrink small-outline package)

DCU = 8 pins

† JEDEC reference for wafer chip scale package (WCSP)



## **AS**

### **Advanced Schottky Logic**

The AS family of high-performance bipolar logic includes over 70 functions that offer high drive capabilities.

This family, combined with the ALS family, can be used to optimize system speed and power through performance budgeting where BiCMOS logic is used. By using AS in speed-critical paths and ALS where speed is less critical, designers can optimize speed and power performance.

The AS family includes gates, flip-flops, counters, drivers, transceivers, registered transceivers, readback latches, clock drivers, register files, and multiplexers.

See [www.ti.com/sc/logic](http://www.ti.com/sc/logic) for the most current data sheets.

# DEVICE SELECTION GUIDE

## AS

DEVICE	NO. PINS	DESCRIPTION	AVAILABILITY					LITERATURE REFERENCE
			MIL	PDIP	SOIC	SOP	SSOP	
SN74AS00	14	Quad 2-Input NAND Gates	✓	✓	✓	✓		SDAS187
SN74AS02	14	Quad 2-Input NOR Gates	✓	✓	✓	✓		SDAS111
SN74AS04	14	Hex Inverters	✓	✓	✓	✓		SDAS063
SN74AS08	14	Quad 2-Input AND Gates	✓	✓	✓	✓		SDAS191
SN74AS10	14	Triple 3-Input NAND Gates	✓	✓	✓	✓		SDAS002
SN74AS11	14	Triple 3-Input AND Gates	✓	✓	✓	✓		SDAS009
SN74AS20	14	Dual 4-Input NAND Gates	✓	✓	✓	✓		SDAS192
SN74AS21	14	Dual 4-Input AND Gates		✓	✓	✓		SDAS085
SN74AS27	14	Triple 3-Input NOR Gates	✓	✓	✓			SDAS112
SN74AS30	14	8-Input NAND Gates	✓	✓	✓	✓		SDAS010
SN74AS32	14	Quad 2-Input OR Gates	✓	✓	✓	✓	✓	SDAS113
SN74AS74A	14	Dual D-Type Flip-Flops with Set and Reset	✓	✓	✓	✓		SDAS143
SN74AS86A	14	Quad 2-Input Exclusive-OR Gates	✓	✓	✓			SDAS006
SN74AS109A	16	Dual Positive-Edge-Triggered J-K Flip-Flops with Set and Reset	✓	✓	✓	✓		SDAS198
SN74AS138	16	3-to-8 Line Inverting Decoders/Demultiplexers	✓	✓	✓	✓		SDAS055
SN74AS151	16	1-of-8 Data Selectors/Multiplexers		✓	✓	✓		SDAS205
SN74AS153	16	Dual 1-of-4 Data Selectors/Multiplexers		✓	✓	✓		SDAS206
SN74AS157	16	Quad 2-to-4 Line Data Selectors/Multiplexers		✓	✓	✓		SDAS081
SN74AS158	16	Quad 2-to-4 Line Data Selectors/Multiplexers		✓	✓	✓		SDAS081
SN74AS161	16	Synchronous 4-Bit Binary Counters	✓	✓	✓	✓		SDAS024
SN74AS163	16	Synchronous 4-Bit Binary Counters	✓	✓	✓	✓		SDAS024
SN74AS169A	16	Synchronous 4-Bit Up/Down Binary Counters	✓	✓	✓			SDAS125
SN74AS174	16	Hex D-Type Flip-Flops with Clear	✓	✓	✓	✓		SDAS207
SN74AS175B	16	Quad D-Type Flip-Flops with Clear	✓	✓	✓	✓		SDAS207
SN74AS181A	24	Arithmetic Logic Units/Function Generators	✓	✓	✓			SDAS209
SN74AS194	16	4-Bit Bidirectional Universal Shift Registers	✓	✓	✓			SDAS212
SN74AS240A	20	Octal Buffers/Drivers with 3-State Outputs	✓	✓	✓	✓		SDAS214
SN74AS241A	20	Octal Buffers/Drivers with 3-State Outputs	✓	✓	✓	✓		SDAS153
SN74AS244A	20	Octal Buffers and Line Drivers with 3-State Outputs	✓	✓	✓	✓		SDAS142
SN74AS245	20	Octal Bus Transceivers with 3-State Outputs	✓	✓	✓	✓		SDAS272
SN74AS250A	24	1-of-16 Data Generators/Multiplexers with 3-State Outputs	✓	✓	✓			SDAS137
SN74AS253A	16	Dual 1-of-4 Data Selectors/Multiplexers with 3-State Outputs		✓	✓			SDAS216

### commercial package description and availability

#### DSBGA (die-size ball grid array)†

YEA, YZA = 5/6/8 pins  
YEP, YZP = 5/6/8 pins

#### LFBGA (low-profile fine-pitch ball grid array)

GGM = 80/100 pins  
GKE, ZKE = 96 pins  
GKF, ZKF = 114 pins

#### VFBGA (very-thin-profile fine-pitch ball grid array)

GQN, ZQN = 20 pins  
GQL, ZQL = 56 pins (also includes 48-pin functions)

#### schedule

✓ = Now    ✚ = Planned

#### PDIP (plastic dual-in-line package)

P = 8 pins  
N = 14/16/20/24 pins  
NT = 24/28 pins

#### PLCC (plastic leaded chip carrier)

FN = 20/28/44/68/84 pins

#### SOIC (small-outline integrated circuit)

D = 8/14/16 pins  
DW = 16/18/20/24/28 pins

#### SOT (small-outline transistor)

PK = 3 pins  
DBV = 3/4/5 pins  
DCY = 4 pins  
DCK = 5/6 pins

#### QFN (quad flatpack no lead)

RGY = 14/16/20 pins  
RGQ = 56 pins

#### QFP (quad flatpack)

RC = 52 pins (FB only)  
PH = 80 pins (FIFOs only)  
PQ = 100/132 pins (FIFOs only)

#### LQFP (low-profile quad flatpack)

PZA = 80 pins

#### TQFP (plastic thin quad flatpack)

PAH = 52 pins  
PAG = 64 pins (FB only)  
PM = 64 pins  
PN = 80 pins  
PCA, PZ = 100 pins (FB only)  
PCB = 120 pins (FIFOs only)

#### SOP (small-outline package)

PS = 8 pins  
NS = 14/16/20/24 pins

#### QSOP (quarter-size small-outline package)

DBQ = 16/20/24 pins

#### SSOP (shrink small-outline package)

DCT = 8 pins  
DB = 14/16/20/24/28/30/38 pins  
DBQ = 16/20/24 pins  
DL = 28/48/56 pins

#### TSSOP (thin shrink small-outline package)

PW = 8/14/16/20/24/28 pins  
DGG = 48/56/64 pins

#### TVSOP (thin very small-outline package)

DGV = 14/16/20/24/48/56 pins  
DBB = 80/100 pins

#### VSSOP (very thin shrink small-outline package)

DCU = 8 pins

† JEDEC reference for wafer chip scale package (WCSP)



DEVICE	NO. PINS	DESCRIPTION	AVAILABILITY					LITERATURE REFERENCE
			MIL	PDIP	SOIC	SOP	SSOP	
SN74AS257	16	Quad 1-of-2 Data Selectors/Multiplexers with 3-State Outputs		✓	✓	✓		SDAS124
SN74AS258	16	Quad 1-of-2 Data Selectors/Multiplexers with 3-State Outputs		✓	✓	✓		SDAS124
SN74AS280	14	9-Bit Odd/Even Parity Generators/Checkers		✓	✓	✓		SDAS038
SN74AS286	14	9-Bit Parity Generators/Checkers with Bus-Driver Parity I/O Port	✓	✓	✓	✓		SDAS050
SN74AS298A	16	Quad 2-Input Multiplexers with Storage		✓	✓	✓		SDAS219
SN74AS373	20	Octal Transparent D-Type Latches with 3-State Outputs	✓	✓	✓	✓		SDAS083
SN74AS374	20	Octal D-Type Edge-Triggered Flip-Flops with 3-State Outputs	✓	✓	✓	✓		SDAS167
SN74AS533A	20	Octal Inverting Transparent Latches with 3-State Outputs		✓	✓			SDAS270
SN74AS573A	20	Octal D-Type Transparent Latches with 3-State Outputs	✓	✓	✓			SDAS048
SN74AS574	20	Octal Edge-Triggered D-Type Flip-Flops with 3-State Outputs	✓	✓	✓			SDAS165
SN74AS575	24	Octal Edge-Triggered D-Type Flip-Flops with 3-State Outputs	✓	✓	✓			SDAS165
SN74AS576	20	Octal Edge-Triggered D-Type Flip-Flops with 3-State Outputs	✓	✓	✓			SDAS065
SN74AS638A	20	Octal Bus Transceivers		✓	✓			SDAS123
SN74AS640	20	Octal Bus Transceivers with 3-State Outputs	✓	✓	✓	✓		SDAS122
SN74AS641	20	Octal Bus Transceivers with Open-Collector Outputs		✓	✓			SDAS300
SN74AS645	20	Octal Bus Transceivers with 3-State Outputs	✓	✓	✓			SDAS278
SN74AS648	24	Octal Registered Bus Transceivers with 3-State Outputs		✓	✓			SDAS039
SN74AS756	20	Octal Buffers and Line Drivers with Open-Collector Outputs	✓	✓	✓			SDAS040
SN74AS757	20	Octal Buffers and Line Drivers with Open-Collector Outputs		✓	✓	✓		SDAS040
SN74AS760	20	Octal Buffers and Line Drivers with Open-Collector Outputs	✓	✓	✓	✓		SDAS141
SN74AS804B	20	Hex 2-Input NAND Drivers	✓	✓	✓			SDAS022
SN74AS805B	20	Hex 2-Input NOR Drivers	✓	✓	✓			SDAS023
SN74AS808B	20	Hex 2-Input NOR Drivers	✓	✓	✓			SDAS018
SN74AS821A	24	10-Bit Bus-Interface Flip-Flops with 3-State Outputs	✓	✓	✓			SDAS230
SN74AS823A	24	9-Bit Bus-Interface Flip-Flops with 3-State Outputs	✓	✓	✓			SDAS231
SN74AS825A	24	8-Bit Bus-Interface Flip-Flops with 3-State Outputs	✓	✓	✓			SDAS020
SN74AS832B	20	Hex 2-Input OR Drivers	✓	✓	✓			SDAS017
SN74AS841A	24	10-Bit Bus-Interface D-Type Latches with 3-State Outputs		✓	✓			SDAS059
SN74AS867	24	Synchronous 8-Bit Up/Down Counters	✓	✓	✓			SDAS115
SN74AS869	24	Synchronous 8-Bit Up/Down Counters	✓	✓	✓			SDAS115
SN74AS873A	24	Dual 4-Bit D-Type Latches with 3-State Outputs	✓	✓	✓			SDAS036
SN74AS874	24	Dual 4-Bit Edge-Triggered D-Type Flip-Flops with 3-State Outputs		✓	✓			SDAS061
SN74AS876	24	Dual 4-Bit Edge-Triggered D-Type Flip-Flops with 3-State Outputs		✓	✓			SDAS061
SN74AS885	24	8-Bit Magnitude Comparators	✓	✓	✓			SDAS236
SN74AS1000A	14	Quad 2-Input NAND Buffers/Drivers	✓	✓	✓	✓		SDAS056
SN74AS1004A	14	Hex Inverting Drivers	✓	✓	✓	✓		SDAS074
SN74AS1008A	14	Quad 2-Input AND Buffers/Drivers		✓	✓			SDAS071
SN74AS1032A	14	Quad 2-Input OR Buffers/Drivers	✓	✓	✓			SDAS072
SN74AS1034A	14	Hex Drivers	✓	✓	✓	✓		SDAS053
SN74AS1804	20	Hex 2-Input NAND Drivers		✓				SDAS042
SN74AS4374B	20	Octal Edge-Triggered D-Type Dual-Rank Flip-Flops with 3-State Outputs		✓	✓	✓		SDAS109
SN74AS8003	8	Dual 2-Input Positive-NAND Gates					✓	SDAS305

# **AUC**

## **Advanced Ultra-Low-Voltage CMOS Logic**

AUC is the industry's first logic family that is optimized for 1.8 V, with operation from sub 1 V (0.8 V) to 2.5 V and the inputs are tolerant to 3.6 V.

This family meets a variety of demands that have been placed on digital electronic designs, including the move to lower supply voltages, faster speeds, smaller form factors, and lower power consumption, without compromising signal integrity. AUC was developed to meet the design parameters for advanced systems, such as telecommunications equipment, high-performance workstations, PC and networking servers, and next-generation portable consumer electronics.

As designers convert the core processors, ASICs, and memories of designs to lower voltages, they need the supporting low-voltage logic functions. AUC provides this support.

See [www.ti.com/sc/logic](http://www.ti.com/sc/logic) for the most current data sheets.

# DEVICE SELECTION GUIDE

## AUC

DEVICE	NO. PINS	DESCRIPTION	AVAILABILITY											LITERATURE REFERENCE	
			DSBGA	LFBGA	QFN	SOP	SOT	SSOP	TSSOP	TVSOP	VFBGA	VSSOP			
SN74AUC1G00	5	Single 2-Input Positive-NAND Gates	✓				✓								SCES368
SN74AUC1G02	5	Single 2-Input Positive-NOR Gates	✓				✓								SCES369
SN74AUC1G04	5	Single Inverter Gates	✓				✓								SCES370
SN74AUC1GU04	5	Single Inverter Gates	✓				✓								SCES371
SN74AUC1G06	5	Single Inverter Buffers/Drivers with Open-Drain Outputs	✓				✓								SCES372
SN74AUC1G07	5	Single Buffers/Drivers with Open-Drain Outputs	✓				✓								SCES373
SN74AUC1G08	5	Single 2-Input Positive-AND Gates	✓				✓								SCES374
SN74AUC1G10	6	Single 3-Input Positive-NAND Gates	+				+								Call
SN74AUC1G11	6	Single 3-Input Positive-AND Gates	+				+								Call
SN74AUC1G14	5	Single Schmitt-Trigger Inverters	✓				✓								SCES375
SN74AUC1G17	5	Single Schmitt-Trigger Buffers	✓				✓								SCES376
SN74AUC1G18	6	1-of-2 Noninverting Demultiplexers with 3-State Deselected Output	+				+								Call
SN74AUC1G19	6	1-of-2 Decoders/Demultiplexers	+				+								Call
SN74AUC1G27	6	Single 3-Input Positive-NOR Gates	+				+								Call
SN74AUC1G32	5	Single Input Positive-OR Gates	✓				✓								SCES377
SN74AUC1G57	6	Configurable Multiple-Function Gates	+				+								Call
SN74AUC1G58	6	Configurable Multiple-Function Gates	+				+								Call
SN74AUC1G66	5	Single Bilateral Analog Switches	✓				✓								SCES386
SN74AUC1G79	5	Single Positive-Edge-Triggered D-Type Flip-Flops	✓				✓								SCES387
SN74AUC1G80	5	Single Positive-Edge-Triggered D-Type Flip-Flops	✓				✓								SCES388
SN74AUC1G86	5	Single 2-Input Exclusive-OR Gates	✓				✓								SCES389
SN74AUC1G97	6	Configurable Multiple-Function Gates	+				+								Call
SN74AUC1G98	6	Configurable Multiple-Function Gates	+				+								Call

### commercial package description and availability

#### DSBGA (die-size ball grid array)†

YEA, YZA = 5/6/8 pins  
YEP, YZP = 5/6/8 pins

#### LFBGA (low-profile fine-pitch ball grid array)

GGM = 80/100 pins  
GKE, ZKE = 96 pins  
GKF, ZKF = 114 pins

#### VFBGA (very-thin-profile fine-pitch ball grid array)

GQN, ZQN = 20 pins  
GQL, ZQL = 56 pins (also includes 48-pin functions)

#### schedule

✓ = Now    + = Planned

#### PDIP (plastic dual-in-line package)

P = 8 pins  
N = 14/16/20/24 pins  
NT = 24/28 pins

#### PLCC (plastic leaded chip carrier)

FN = 20/28/44/68/84 pins

#### SOIC (small-outline integrated circuit)

D = 8/14/16 pins  
DW = 16/18/20/24/28 pins

#### SOT (small-outline transistor)

PK = 3 pins  
DBV = 3/4/5 pins  
DCY = 4 pins  
DCK = 5/6 pins

#### QFN (quad flatpack no lead)

RGY = 14/16/20 pins  
RGQ = 56 pins

#### QFP (quad flatpack)

RC = 52 pins (FB only)  
PH = 80 pins (FIFOs only)  
PQ = 100/132 pins (FIFOs only)

#### LQFP (low-profile quad flatpack)

PZA = 80 pins

#### TQFP (plastic thin quad flatpack)

PAH = 52 pins  
PAG = 64 pins (FB only)  
PM = 64 pins  
PN = 80 pins  
PCA, PZ = 100 pins (FB only)  
PCB = 120 pins (FIFOs only)

#### SOP (small-outline package)

PS = 8 pins  
NS = 14/16/20/24 pins

#### QSOP (quarter-size small-outline package)

DBQ = 16/20/24 pins

#### SSOP (shrink small-outline package)

DCT = 8 pins  
DB = 14/16/20/24/28/30/38 pins  
DBQ = 16/20/24 pins  
DL = 28/48/56 pins

#### TSSOP (thin shrink small-outline package)

PW = 8/14/16/20/24/28 pins  
DGG = 48/56/64 pins

#### TVSOP (thin very small-outline package)

DGV = 14/16/20/24/48/56 pins  
DBB = 80/100 pins

#### VSSOP (very thin shrink small-outline package)

DCU = 8 pins

† JEDEC reference for wafer chip scale package (WCSP)



DEVICE	NO. PINS	DESCRIPTION	AVAILABILITY										LITERATURE REFERENCE		
			DSBGA	LFBGA	QFN	SOP	SOT	SSOP	TSSOP	TVSOP	VFBGA	VSSOP			
SN74AUC1G125	5	Single Bus Buffer Gates with 3-State Outputs	✓				✓								SCES382
SN74AUC1G126	5	Single Bus Buffer Gates with 3-State Outputs	+				✓								SCES383
SN74AUC1G240	5	Single Buffers/Drivers with 3-State Outputs	+				✓								SCES384
SN74AUC1G332	6	Single 3-Input Positive-OR Gates	+				+								Call
SN74AUC1G386	6	Single 3-Input Positive-XOR Gates	+				+								Call
SN74AUC2G00	8	Dual 2-Input NAND Gates	✓				✓								SCES440
SN74AUC2G02	8	Dual 2-Input NOR Gates	+				✓								SCES441
SN74AUC2G04	6	Dual Inverters	✓				✓								SCES437
SN74AUC2GU04	6	Dual Inverters	+				✓								SCES438
SN74AUC2G06	6	Dual Inverter Buffers/Drivers with Open-Drain Outputs	✓				✓								SCES442
SN74AUC2G07	6	Dual Buffers/Drivers with Open-Drain Outputs	✓				✓								SCES443
SN74AUC2G08	8	Dual 2-Input AND Gates	+				+								Call
SN74AUC2G14	6	Dual Schmitt-Trigger Inverters	+				+								Call
SN74AUC2G17	6	Dual Schmitt-Trigger Buffers	+				+								Call
SN74AUC2G32	8	Dual 2-Input OR Gates	+				+								Call
SN74AUC2G34	6	Dual Buffer Gates	+				+								Call
SN74AUC2G53	8	Analog Multiplexers/Demultiplexers	+				+								Call
SN74AUC2G66	8	Dual Bilateral Switches	+				+								Call
SN74AUC2G74	8	Dual Edge-Triggered D-Type Flip-Flops with Clear and Preset	+				+								Call
SN74AUC2G79	8	Dual Positive-Edge-Triggered D-Type Flip-Flops	+				+								Call
SN74AUC2G80	8	Dual Positive-Edge-Triggered D-Type Flip-Flops	+				+								Call
SN74AUC2G86	8	Dual 2-Input Exclusive-OR Gates	+				+								Call
SN74AUC2G125	8	Dual Bus Buffer Gates with 3-State Outputs	+				+								Call
SN74AUC2G126	8	Dual Bus Buffers with 3-State Outputs	+				+								Call
SN74AUC2G157	8	Dual 2-to-1 Line Data Selectors/Multiplexers	+				+								Call
SN74AUC2G240	8	Dual Buffers/Drivers with 3-State Outputs	+				+								Call
SN74AUC2G241	8	Dual Buffers/Drivers with 3-State Outputs	+				+								Call
SN74AUC2G257	8	Dual 2-1 Line Data Selectors/Multiplexers with 3-State Outputs	+				+								Call
SN74AUC3G04	8	Triple Inverters	+				+								Call
SN74AUC3GU04	8	Triple Inverters	+				+								Call
SN74AUC3G06	8	Triple Inverter Buffers/Drivers with Open-Drain Outputs	+				+								Call

# DEVICE SELECTION GUIDE

## AUC

DEVICE	NO. PINS	DESCRIPTION	AVAILABILITY										LITERATURE REFERENCE		
			DSBGA	LFBGA	QFN	SOP	SOT	SSOP	TSSOP	TVSOP	VFBGA	VSSOP			
SN74AUC3G07	8	Triple Buffers/Drivers with Open-Drain Outputs	+					+							Call
SN74AUC3G14	8	Triple Schmitt-Trigger Inverters	+					+							Call
SN74AUC3G17	8	Triple Schmitt-Trigger Buffers	+					+							Call
SN74AUC3G34	8	Triple Buffer Gates	+					+							Call
SN74AUC240	20	Octal Buffers/Drivers with 3-State Outputs			✓										SCES430
SN74AUC244	20	Octal Buffers/Drivers with 3-State Outputs			✓										SCES432
SN74AUC245	20	Octal Bus Transceivers with 3-State Outputs			✓								+		SCES419
SN74AUC16240	48	16-Bit Buffers/Drivers with 3-State Outputs								✓	✓	✓			SCES390
SN74AUC16244	48/56	16-Bit Buffers/Drivers with 3-State Outputs								✓	✓		+		SCES399
SN74AUC16245	48	16-Bit Transceivers with 3-State Outputs								✓	✓	✓			SCES392
SN74AUC16373	48	16-Bit Transparent D-Type Latches with 3-State Outputs								✓	✓				SCES401
SN74AUC16374	48	16-Bit Edge-Triggered D-Type Flip-Flops with 3-State Outputs								✓	✓	✓			SCES403
SN74AUC16501	56	18-Bit Universal Bus Transceivers with 3-State Outputs								✓	✓				SCES418
SN74AUC32245	96	32-Bit Transceivers with 3-State Outputs		✓											SCES410
SN74AUCH240	20	Octal Buffers/Drivers with 3-State Outputs			✓										SCES431
SN74AUCH245	20	Octal Bus Transceivers with 3-State Outputs			✓										SCES420
SN74AUCH16244	48	16-Bit Buffers/Drivers with 3-State Outputs								✓	✓	✓			SCES391
SN74AUCH32244	96	32-Bit Buffers/Drivers with 3-State Outputs		✓											SCES412

## AVC

### Advanced Very-Low-Voltage CMOS Logic

TI's new AVC logic family provides designers the tools to create advanced high-speed systems with propagation delays of less than 2 ns. Though optimized for 2.5-V systems, AVC logic supports operating voltages between 1.2 V and 3.6 V. The AVC family features TI's DOC™ circuitry, which dynamically lowers circuit output impedance during signal transition for fast rise and fall times, and then raises the impedance after signal transmission to reduce ringing.

Trends in digital electronics design emphasize lower power consumption, lower supply voltages, faster operating speeds, smaller timing budgets, and heavier loads. Many designs are making the transition from 3.3 V to 2.5 V, with bus speeds increasing beyond 100 MHz. Signal integrity need not be compromised to meet these design requirements. TI's AVC family is designed to meet the needs of these high-speed, low-voltage systems, including next-generation high-performance workstations, PCs, networking servers, and telecommunications switching equipment.

Key features:

- Sub-2-ns maximum  $t_{pd}$  at 2.5 V for AVC16245
- Designed for next-generation, high-performance PCs, workstations, and servers
- DOC circuitry enhances high-speed, low-noise operation.
- Supports mixed-voltage systems
- Optimized for 2.5 V; operable from 1.2 V to 3.6 V
- Bus-hold feature eliminates need for external resistors on unused input pins.
- $I_{off}$  supports partial power down.

See [www.ti.com/sc/logic](http://www.ti.com/sc/logic) for the most current data sheets.



# DEVICE SELECTION GUIDE

## AVC

DEVICE	NO. PINS	DESCRIPTION	AVAILABILITY				LITERATURE REFERENCE
			LFBGA	TSSOP	TVSOP	VFBGA	
SN74AVC16244	48	16-Bit Buffers/Drivers with 3-State Outputs		✓	✓	✓	SCES150
SN74AVC16245	48	16-Bit Bus Transceivers with 3-State Outputs		✓	✓		SCES142
SN74AVC16269	56	12-Bit to 24-Bit Registered Bus Exchangers with 3-State Outputs			✓		SCES152
SN74AVC16334	48	16-Bit Universal Bus Drivers with 3-State Outputs		✓	✓		SCES154
SN74AVC16373	48	16-Bit Transparent D-Type Latches with 3-State Outputs		✓	✓	✓	SCES156
SN74AVC16374	48	16-Bit Edge-Triggered D-Type Flip-Flops with 3-State Outputs		✓	✓	✓	SCES158
SN74AVC16646	56	16-Bit Bus Transceivers and Registers with 3-State Outputs		✓	✓		SCES181
SN74AVC16722	64	20-Bit D-Type Flip-Flops with 3-State Outputs		✓			SCES166
SN74AVC16827	56	20-Bit Buffers/Drivers with 3-State Outputs		✓	✓		SCES176
SN74AVC16834	56	18-Bit Universal Bus Drivers with 3-State Outputs		✓	✓		SCES183
SN74AVC16835	56	18-Bit Universal Bus Drivers with 3-State Outputs		✓	✓		SCES168
SN74AVC32373	96	1.2-V/3.3-V 32-Bit Transparent D-Type Latches with 3-State Outputs	+				SCES327
SN74AVCA164245	48/56	16-Bit Dual-Supply Bus Transceivers with Configurable Voltage Translation and 3-State Outputs		✓	✓	✓	SCES395
SN74AVCAH164245	48/56	16-Bit Dual-Supply Bus Transceivers with Configurable Voltage Translation and 3-State Outputs		✓	✓	✓	SCES396
SN74AVCB164245	48/56	16-Bit Dual-Supply Bus Transceivers with Configurable Voltage Translation and 3-State Outputs		✓	✓	✓	SCES394
SN74AVCBH164245	48/56	16-Bit Dual-Supply Bus Transceivers with Configurable Voltage Translation and 3-State Outputs		✓	✓	✓	SCES393

### commercial package description and availability

#### DSBGA (die-size ball grid array)†

YEA, YZA = 5/6/8 pins  
YEP, YZP = 5/6/8 pins

#### LFBGA (low-profile fine-pitch ball grid array)

GGM = 80/100 pins  
GKE, ZKE = 96 pins  
GKF, ZKF = 114 pins

#### VFBGA (very-thin-profile fine-pitch ball grid array)

GQN, ZQN = 20 pins  
GQL, ZQL = 56 pins (also includes 48-pin functions)

#### schedule

✓ = Now    + = Planned

#### PDIP (plastic dual-in-line package)

P = 8 pins  
N = 14/16/20/24 pins  
NT = 24/28 pins

#### PLCC (plastic leaded chip carrier)

FN = 20/28/44/68/84 pins

#### SOIC (small-outline integrated circuit)

D = 8/14/16 pins  
DW = 16/18/20/24/28 pins

#### SOT (small-outline transistor)

PK = 3 pins  
DBV = 3/4/5 pins  
DCY = 4 pins  
DCK = 5/6 pins

#### QFN (quad flatpack no lead)

RGY = 14/16/20 pins  
RGQ = 56 pins

#### QFP (quad flatpack)

RC = 52 pins (FB only)  
PH = 80 pins (FIFOs only)  
PQ = 100/132 pins (FIFOs only)

#### LQFP (low-profile quad flatpack)

PZA = 80 pins

#### TQFP (plastic thin quad flatpack)

PAH = 52 pins  
PAG = 64 pins (FB only)  
PM = 64 pins  
PN = 80 pins  
PCA, PZ = 100 pins (FB only)  
PCB = 120 pins (FIFOs only)

#### SOP (small-outline package)

PS = 8 pins  
NS = 14/16/20/24 pins

#### QSOP (quarter-size small-outline package)

DBQ = 16/20/24 pins

#### SSOP (shrink small-outline package)

DCT = 8 pins  
DB = 14/16/20/24/28/30/38 pins  
DBQ = 16/20/24 pins  
DL = 28/48/56 pins

#### TSSOP (thin shrink small-outline package)

PW = 8/14/16/20/24/28 pins  
DGG = 48/56/64 pins

#### TVSOP (thin very small-outline package)

DGV = 14/16/20/24/48/56 pins  
DBB = 80/100 pins

#### VSSOP (very thin shrink small-outline package)

DCU = 8 pins

† JEDEC reference for wafer chip scale package (WCSP)

## **BCT**

### **BiCMOS Technology Logic**

BCT is a family of 8-, 9-, and 10-bit drivers, latches, transceivers, and registered transceivers. Designed specifically for bus-interface applications, BCT offers TTL I/O with high speeds, 64-mA output drive, and very low power in the disabled mode. Over 50 BCT functions are in production.

The BCT25xxx series of fast, high-drive bus-interface functions provides incident-wave switching required by large backplane applications. Designed specifically to ensure incident-wave switching down to 25  $\Omega$ , these low-impedance driver devices can maximize the speed and reliability of heavily loaded systems. Each device of this series delivers 188 mA of  $I_{OL}$  drive current.

Also included in TI's BCT family are devices with series damping resistors to reduce overshoot and undershoot that can occur in memory-driving applications.

See [www.ti.com/sc/logic](http://www.ti.com/sc/logic) for the most current data sheets.

## **64BCT**

### **64-Series BiCMOS Technology Logic**

The 64BCT family offers all the features found in TI's standard BCT family. In addition, the family is characterized for operation from  $-40^{\circ}\text{C}$  to  $85^{\circ}\text{C}$  and incorporates circuitry to protect the device in live-insertion applications.

See [www.ti.com/sc/logic](http://www.ti.com/sc/logic) for the most current data sheets.

# DEVICE SELECTION GUIDE

## BCT

DEVICE	NO. PINS	DESCRIPTION	AVAILABILITY					LITERATURE REFERENCE
			MIL	PDIP	SOIC	SOP	SSOP	
SN74BCT125A	14	Quad Bus Buffers with 3-State Outputs	✓	✓	✓	✓		SCBS032
SN74BCT126A	14	Quad Bus Buffers with 3-State Outputs	✓	✓	✓			SCBS252
SN74BCT240	20	Octal Buffers/Drivers with 3-State Outputs	✓	✓	✓	✓	✓	SCBS004
SN74BCT241	20	Octal Buffers/Drivers with 3-State Outputs	✓	✓	✓	✓		SCBS005
SN74BCT244	20	Octal Buffers and Line Drivers with 3-State Outputs	✓	✓	✓	✓	✓	SCBS006
SN74BCT245	20	Octal Bus Transceivers with 3-State Outputs	✓	✓	✓	✓	✓	SCBS013
SN74BCT373	20	Octal Transparent D-Type Latches with 3-State Outputs	✓	✓	✓	✓	✓	SCBS016
SN74BCT374	20	Octal Edge-Triggered D-Type Flip-Flops with 3-State Outputs	✓	✓	✓	✓		SCBS019
SN74BCT540A	20	Inverting Octal Buffers and Line Drivers with 3-State Outputs	✓	✓	✓	✓		SCBS012
SN74BCT541A	20	Octal Buffers and Line Drivers with 3-State Outputs	✓	✓	✓	✓		SCBS011
SN74BCT543	24	Octal Registered Transceivers with 3-State Outputs	✓	✓	✓	✓		SCBS026
SN74BCT573	20	Octal Transparent D-Type Latches with 3-State Outputs	✓	✓	✓	✓		SCBS071
SN74BCT574	20	Octal Edge-Triggered D-Type Flip-Flops with 3-State Outputs	✓	✓	✓	✓	✓	SCBS074
SN74BCT623	20	Octal Bus Transceivers with 3-State Outputs	✓	✓	✓	✓		SCBS020
SN74BCT640	20	Octal Bus Transceivers with 3-State Outputs	✓	✓	✓			SCBS025
SN74BCT756	20	Octal Buffers and Line Drivers with Open-Collector Outputs		✓	✓			SCBS056
SN74BCT757	20	Octal Buffers and Line Drivers with Open-Collector Outputs		✓	✓			SCBS041
SN74BCT760	20	Octal Buffers and Line Drivers with Open-Collector Outputs	✓	✓	✓	✓		SCBS034
SN74BCT2240	20	Octal Buffers and Line/MOS Drivers with Series Damping Resistors and 3-State Outputs	✓	✓	✓	✓	✓	SCBS030
SN74BCT2241	20	Octal Buffers and Line/MOS Drivers with Series Damping Resistors and 3-State Outputs		✓	✓	✓		SCBS035
SN74BCT2244	20	Octal Buffers/Line Drivers with Series Damping Resistors and 3-State Outputs	✓	✓	✓	✓		SCBS017
SN74BCT2245	20	Octal Transceivers and Line MOS Drivers with Series Damping Resistors and 3-State Outputs		✓	✓	✓	✓	SCBS102
SN74BCT2414	20	Dual 2-Line to 4-Line Memory Decoders with On-Chip Supply-Voltage Monitor		✓	✓			SCBS059
SN74BCT2827C	24	10-Bit Buffers/Drivers with Series Damping Resistors and 3-State Outputs		✓	✓			SCBS007
SN74BCT25244	24	25-Ω Octal Buffers/Drivers with 3-State Outputs		✓	✓	✓		SCBS064
SN74BCT25245	24	25-Ω Octal Bus Transceivers with 3-State Outputs		✓	✓	✓		SCBS053
SN74BCT25642	24	25-Ω Octal Bus Transceivers with Open-Collector Outputs		✓	✓			SCBS047
SN74BCT29821	24	10-Bit Bus-Interface Flip-Flops with 3-State Outputs		✓	✓			SCBS021
SN74BCT29825	24	Octal Bus-Interface Flip-Flops with 3-State Outputs		✓	✓			SCBS075
SN74BCT29827B	24	10-Bit Buffers/Drivers with 3-State Outputs		✓	✓	✓		SCBS008

### commercial package description and availability

#### DSBGA (die-size ball grid array)†

YEA, YZA = 5/6/8 pins  
YEP, YZP = 5/6/8 pins

#### LFBGA (low-profile fine-pitch ball grid array)

GGM = 80/100 pins  
GKE, ZKE = 96 pins  
GKF, ZKF = 114 pins

#### VFBGA (very-thin-profile fine-pitch ball grid array)

GQN, ZQN = 20 pins  
GQL, ZQL = 56 pins (also includes 48-pin functions)

#### schedule

✓ = Now    ✚ = Planned

#### PDIP (plastic dual-in-line package)

P = 8 pins  
N = 14/16/20/24 pins  
NT = 24/28 pins

#### PLCC (plastic leaded chip carrier)

FN = 20/28/44/68/84 pins

#### SOIC (small-outline integrated circuit)

D = 8/14/16 pins  
DW = 16/18/20/24/28 pins

#### SOT (small-outline transistor)

PK = 3 pins  
DBV = 3/4/5 pins  
DCY = 4 pins  
DCK = 5/6 pins

#### QFN (quad flatpack no lead)

RGY = 14/16/20 pins  
RGQ = 56 pins

#### QFP (quad flatpack)

RC = 52 pins (FB only)  
PH = 80 pins (FIFOs only)  
PQ = 100/132 pins (FIFOs only)

#### LQFP (low-profile quad flatpack)

PZA = 80 pins

#### TQFP (plastic thin quad flatpack)

PAH = 52 pins  
PAG = 64 pins (FB only)  
PM = 64 pins  
PN = 80 pins  
PCA, PZ = 100 pins (FB only)  
PCB = 120 pins (FIFOs only)

#### SOP (small-outline package)

PS = 8 pins  
NS = 14/16/20/24 pins

#### QSOP (quarter-size small-outline package)

DBQ = 16/20/24 pins

#### SSOP (shrink small-outline package)

DCT = 8 pins  
DB = 14/16/20/24/28/30/38 pins  
DBQ = 16/20/24 pins  
DL = 28/48/56 pins

#### TSSOP (thin shrink small-outline package)

PW = 8/14/16/20/24/28 pins  
DGG = 48/56/64 pins

#### TVSOP (thin very small-outline package)

DGV = 14/16/20/24/48/56 pins  
DBB = 80/100 pins

#### VSSOP (very thin shrink small-outline package)

DCU = 8 pins

† JEDEC reference for wafer chip scale package (WCSP)



DEVICE	NO. PINS	DESCRIPTION	AVAILABILITY					LITERATURE REFERENCE	
			MIL	PDIP	SOIC	SOP	SSOP		TSSOP
SN74BCT29843	24	9-Bit D-Type Bus-Interface Latches with 3-State Outputs		✓	✓				SCBS256
SN74BCT29863B	24	9-Bit Bus Transceivers with 3-State Outputs		✓	✓				SCBS015
SN74BCT29864B	24	9-Bit Bus Transceivers with 3-State Outputs		✓	✓				SCBS010

# DEVICE SELECTION GUIDE

## 64BCT

DEVICE	NO. PINS	DESCRIPTION	AVAILABILITY		LITERATURE REFERENCE
			PDIP	SOIC	
SN64BCT125A	14	Quad Bus Buffers with 3-State Outputs	✓	✓	SCBS052
SN64BCT126A	14	Quad Bus Buffers with 3-State Outputs	✓	✓	SCBS051
SN64BCT244	20	Octal Buffers and Line Drivers with 3-State Outputs	✓	✓	SCBS027
SN64BCT245	20	Octal Bus Transceivers with 3-State Outputs	✓	✓	SCBS040
SN64BCT757	20	Octal Buffers and Line Drivers with Open-Collector Outputs	✓	✓	SCBS479
SN64BCT25244	24	25-Ω Octal Buffers/Drivers with 3-State Outputs	✓	✓	SCBS477
SN64BCT25245	24	25-Ω Octal Bus Transceivers with 3-State Outputs	✓	✓	SCBS060

### commercial package description and availability

#### DSBGA (die-size ball grid array)†

YEA, YZA = 5/6/8 pins  
YEP, YZP = 5/6/8 pins

#### LFPGA (low-profile fine-pitch ball grid array)

GGM = 80/100 pins  
GKE, ZKE = 96 pins  
GKF, ZKF = 114 pins

#### VFBGA (very-thin-profile fine-pitch ball grid array)

GQN, ZQN = 20 pins  
GQL, ZQL = 56 pins (also includes 48-pin functions)

#### schedule

✓ = Now    ✚ = Planned

† JEDEC reference for wafer chip scale package (WCSP)

#### PDIP (plastic dual-in-line package)

P = 8 pins  
N = 14/16/20/24 pins  
NT = 24/28 pins

#### PLCC (plastic leaded chip carrier)

FN = 20/28/44/68/84 pins

#### SOIC (small-outline integrated circuit)

D = 8/14/16 pins  
DW = 16/18/20/24/28 pins

#### SOT (small-outline transistor)

PK = 3 pins  
DBV = 3/4/5 pins  
DCY = 4 pins  
DCK = 5/6 pins

#### QFN (quad flatpack no lead)

RGY = 14/16/20 pins  
RGQ = 56 pins

#### QFP (quad flatpack)

RC = 52 pins (FB only)  
PH = 80 pins (FIFOs only)  
PQ = 100/132 pins (FIFOs only)

#### LQFP (low-profile quad flatpack)

PZA = 80 pins

#### TQFP (plastic thin quad flatpack)

PAH = 52 pins  
PAG = 64 pins (FB only)  
PM = 64 pins  
PN = 80 pins  
PCA, PZ = 100 pins (FB only)  
PCB = 120 pins (FIFOs only)

#### SOP (small-outline package)

PS = 8 pins  
NS = 14/16/20/24 pins

#### QSOP (quarter-size small-outline package)

DBQ = 16/20/24 pins

#### SSOP (shrink small-outline package)

DCT = 8 pins  
DB = 14/16/20/24/28/30/38 pins  
DBQ = 16/20/24 pins  
DL = 28/48/56 pins

#### TSSOP (thin shrink small-outline package)

PW = 8/14/16/20/24/28 pins  
DGG = 48/56/64 pins

#### TVSOP (thin very small-outline package)

DGV = 14/16/20/24/48/56 pins  
DBB = 80/100 pins

#### VSSOP (very thin shrink small-outline package)

DCU = 8 pins



## **BTA**

### **Bus-Termination Arrays**

TI's BTA family offers a space-saving, efficient, and effective solution to bus-termination requirements. In high-speed digital systems with long transmission lines, reflecting waves on the line can cause voltage undershoots and overshoots that lead to malfunctions at the driven input. A BTA is a series of diodes that clamps a signal on a bus or any other signal trace using high-frequency logic to limit overshoot and undershoot problems.

See [www.ti.com/sc/logic](http://www.ti.com/sc/logic) for the most current data sheets.

# DEVICE SELECTION GUIDE

## BTA

DEVICE	NO. PINS	DESCRIPTION	AVAILABILITY					LITERATURE REFERENCE
			MIL	PDIP	SOIC	SSOP	TSSOP	
SN74F1016	20	16-Bit Schottky Barrier Diode R-C Bus-Termination Arrays			✓			SDFS093
SN74S1050	16	12-Bit Schottky Barrier Diode Bus-Termination Arrays		✓	✓			SDLS015
SN74S1051	16	12-Bit Schottky Barrier Diode Bus-Termination Arrays		✓	✓			SDLS018
SN74S1052	20	16-Bit Schottky Barrier Diode Bus-Termination Arrays		✓	✓			SDLS016
SN74S1053	20	16-Bit Schottky Barrier Diode Bus-Termination Arrays		✓	✓	✓		SDLS017
SN74F1056	16	8-Bit Schottky Barrier Diode Bus-Termination Arrays			✓			SDFS085
SN74ACT1071	14	10-Bit Bus-Termination Networks with Bus-Hold Function			✓			SCAS192
SN74ACT1073	20	16-Bit Bus-Termination Networks with Bus-Hold Function			✓			SCAS193
CD40117B	14	Programmable Dual 4-Bit Terminators	✓	✓			✓	SCHS101

### commercial package description and availability

#### DSBGA (die-size ball grid array)†

YEA, YZA = 5/6/8 pins  
YEP, YZP = 5/6/8 pins

#### LFPGA (low-profile fine-pitch ball grid array)

GGM = 80/100 pins  
GKE, ZKE = 96 pins  
GKF, ZKF = 114 pins

#### VFPGA (very-thin-profile fine-pitch ball grid array)

GQN, ZQN = 20 pins  
GQL, ZQL = 56 pins (also includes 48-pin functions)

#### schedule

✓ = Now    ✚ = Planned

† JEDEC reference for wafer chip scale package (WCSP)

#### PDIP (plastic dual-in-line package)

P = 8 pins  
N = 14/16/20/24 pins  
NT = 24/28 pins

#### PLCC (plastic leaded chip carrier)

FN = 20/28/44/68/84 pins

#### SOIC (small-outline integrated circuit)

D = 8/14/16 pins  
DW = 16/18/20/24/28 pins

#### SOT (small-outline transistor)

PK = 3 pins  
DBV = 3/4/5 pins  
DCY = 4 pins  
DCK = 5/6 pins

#### QFN (quad flatpack no lead)

RGY = 14/16/20 pins  
RGQ = 56 pins

#### QFP (quad flatpack)

RC = 52 pins (FB only)  
PH = 80 pins (FIFOs only)  
PQ = 100/132 pins (FIFOs only)

#### LQFP (low-profile quad flatpack)

PZA = 80 pins

#### TQFP (plastic thin quad flatpack)

PAH = 52 pins  
PAG = 64 pins (FB only)  
PM = 64 pins  
PN = 80 pins  
PCA, PZ = 100 pins (FB only)  
PCB = 120 pins (FIFOs only)

#### SOP (small-outline package)

PS = 8 pins  
NS = 14/16/20/24 pins

#### QSOP (quarter-size small-outline package)

DBQ = 16/20/24 pins

#### SSOP (shrink small-outline package)

DCT = 8 pins  
DB = 14/16/20/24/28/30/38 pins  
DBQ = 16/20/24 pins  
DL = 28/48/56 pins

#### TSSOP (thin shrink small-outline package)

PW = 8/14/16/20/24/28 pins  
DGG = 48/56/64 pins

#### TVSOP (thin very small-outline package)

DGV = 14/16/20/24/48/56 pins  
DBB = 80/100 pins

#### VSSOP (very thin shrink small-outline package)

DCU = 8 pins



## **CB3Q**

### **Low-Voltage High-Bandwidth Bus-Switch Crossbar Technology Logic**

Developed to complement TI's existing CBT and CBTLV bus-switch products, the new CB3Q family provides high-performance, low-power replacements for standard bus-interface devices when signal buffering (current drive) is not required. The CB3Q 2.5-V/3.3-V low-voltage, high-bandwidth, bus-switch family offers very low and flat on-state resistance, 0-V to 5-V rail-to-rail switching, and very low input/output capacitance to minimize capacitance loading and signal distortion. Specifically designed to support today's bandwidth-critical computing and networking applications, the CB3Q family provides a high-performance interface solution ideally suited for broadband communications and networking infrastructure equipment (switches, routers, hubs, wireless base stations, DSLAMs, LAN/WAN, network storage), as well as other data-intensive applications (gigabit-Ethernet routers, ATM switches, SONET/ATM multiplexers, servers, workstations, video processing, and PCI-based computing). The CB3Q bus-switch family offers the features and performance necessary to optimize your high-bandwidth system designs.

The CB3Q devices are available in advanced packaging, such as the quarter-size small-outline package (QSOP), small-outline integrated circuit (SOIC), shrink small-outline package (SSOP), thin shrink small-outline package (TSSOP), thin very small-outline package (TVSOP), and quad flatpack no-lead (QFN) package for reduced board area.

See [www.ti.com/sc/logic](http://www.ti.com/sc/logic) for additional information regarding the CB3Q product family.



# DEVICE SELECTION GUIDE

## CB3Q

DEVICE	NO. PINS	DESCRIPTION	AVAILABILITY			LITERATURE REFERENCE
			QSOP	TSSOP	TVSOP	
SN74CB3Q3306A	8	2.5-V/3.3-V Low-Voltage High-Bandwidth Dual FET Bus Switches		✓		SCDS113
SN74CB3Q3384A	24	2.5-V/3.3-V Low-Voltage High-Bandwidth 10-Bit FET Bus Switches	✓	✓	✓	SCDS114

### commercial package description and availability

#### DSBGA (die-size ball grid array)†

YEA, YZA = 5/6/8 pins  
YEP, YZP = 5/6/8 pins

#### LFBGA (low-profile fine-pitch ball grid array)

GGM = 80/100 pins  
GKE, ZKE = 96 pins  
GKF, ZKF = 114 pins

#### VFBGA (very-thin-profile fine-pitch ball grid array)

GQN, ZQN = 20 pins  
GQL, ZQL = 56 pins (also includes 48-pin functions)

#### schedule

✓ = Now    ✚ = Planned

† JEDEC reference for wafer chip scale package (WCSP)

#### PDIP (plastic dual-in-line package)

P = 8 pins  
N = 14/16/20/24 pins  
NT = 24/28 pins

#### PLCC (plastic leaded chip carrier)

FN = 20/28/44/68/84 pins

#### SOIC (small-outline integrated circuit)

D = 8/14/16 pins  
DW = 16/18/20/24/28 pins

#### SOT (small-outline transistor)

PK = 3 pins  
DBV = 3/4/5 pins  
DCY = 4 pins  
DCK = 5/6 pins

#### QFN (quad flatpack no lead)

RGY = 14/16/20 pins  
RGQ = 56 pins

#### QFP (quad flatpack)

RC = 52 pins (FB only)  
PH = 80 pins (FIFOs only)  
PQ = 100/132 pins (FIFOs only)

#### LQFP (low-profile quad flatpack)

PZA = 80 pins

#### TQFP (plastic thin quad flatpack)

PAH = 52 pins  
PAG = 64 pins (FB only)  
PM = 64 pins  
PN = 80 pins  
PCA, PZ = 100 pins (FB only)  
PCB = 120 pins (FIFOs only)

#### SOP (small-outline package)

PS = 8 pins  
NS = 14/16/20/24 pins

#### QSOP (quarter-size small-outline package)

DBQ = 16/20/24 pins

#### SSOP (shrink small-outline package)

DCT = 8 pins  
DB = 14/16/20/24/28/30/38 pins  
DBQ = 16/20/24 pins  
DL = 28/48/56 pins

#### TSSOP (thin shrink small-outline package)

PW = 8/14/16/20/24/28 pins  
DGG = 48/56/64 pins

#### TVSOP (thin very small-outline package)

DGV = 14/16/20/24/48/56 pins  
DBB = 80/100 pins

#### VSSOP (very thin shrink small-outline package)

DCU = 8 pins



## CB3T

### Low-Voltage Translator Bus-Switch Crossbar Technology Logic

Developed to complement TI's existing CBT and CBTLV bus-switch products, the new CB3T family provides high-performance, low-power replacements for standard bus-interface devices when signal buffering (current drive) is not required. The CB3T 2.5-V/3.3-V bidirectional voltage translator bus-switch family fully supports mixed-mode signal operation on all ports, and is ideally suited for mixed 2.3-V to 5.5-V system environments. The CB3T bus switches provide 5-V input to 3.3-V output level shifting with a 3.3-V  $V_{CC}$ , and 5-V or 3.3-V input to 2.5-V output level shifting with a 2.5-V  $V_{CC}$ . This voltage-translation feature allows the CB3T family to provide a high-performance interface between a myriad of components (memory, processors, logic, ASICs, I/O peripherals, etc.) that require the different signaling standards (TTL, LVTTTL, etc.) common in mixed-mode environments. Specifically designed to support today's portable computing and communications applications, the CB3T family provides a high-performance, low-power interface solution ideally suited for laptop computers, PDAs, and cell phones, as well as any accompanying docking stations. The CB3T bus-switch family offers the features and performance necessary to optimize both mixed-mode signal and power-critical portable system designs.

The CB3T devices are available in advanced packaging, such as the quarter-size small-outline package (QSOP), small-outline integrated circuit (SOIC), shrink small-outline package (SSOP), thin shrink small-outline package (TSSOP), thin very small-outline package (TVSOP), quad flatpack no-lead (QFN) package, and very thin shrink small-outline package (VSSOP) for reduced board area.

See [www.ti.com/sc/logic](http://www.ti.com/sc/logic) for additional information regarding the CB3T product family.

# DEVICE SELECTION GUIDE

## CB3T

DEVICE	NO. PINS	DESCRIPTION	AVAILABILITY				LITERATURE REFERENCE
			SSOP	TSSOP	TVSOP	VSSOP	
SN74CB3T3125	14/16	Quad FET Bus Switches		✓	✓		SCDS120
SN74CB3T3306	8	3.3-V Low-Voltage Dual FET Bus Switches with 5-V-Tolerant Level Shifter	✓			✓	SCDS119

### commercial package description and availability

#### DSBGA (die-size ball grid array)†

YEA, YZA = 5/6/8 pins  
YEP, YZP = 5/6/8 pins

#### LFBGA (low-profile fine-pitch ball grid array)

GGM = 80/100 pins  
GKE, ZKE = 96 pins  
GKF, ZKF = 114 pins

#### VFBGA (very-thin-profile fine-pitch ball grid array)

GQN, ZQN = 20 pins  
GQL, ZQL = 56 pins (also includes 48-pin functions)

#### schedule

✓ = Now   ✚ = Planned

† JEDEC reference for wafer chip scale package (WCSP)

#### PDIP (plastic dual-in-line package)

P = 8 pins  
N = 14/16/20/24 pins  
NT = 24/28 pins

#### PLCC (plastic leaded chip carrier)

FN = 20/28/44/68/84 pins

#### SOIC (small-outline integrated circuit)

D = 8/14/16 pins  
DW = 16/18/20/24/28 pins

#### SOT (small-outline transistor)

PK = 3 pins  
DBV = 3/4/5 pins  
DCY = 4 pins  
DCK = 5/6 pins

#### QFN (quad flatpack no lead)

RGY = 14/16/20 pins  
RGQ = 56 pins

#### QFP (quad flatpack)

RC = 52 pins (FB only)  
PH = 80 pins (FIFOs only)  
PQ = 100/132 pins (FIFOs only)

#### LQFP (low-profile quad flatpack)

PZA = 80 pins

#### TQFP (plastic thin quad flatpack)

PAH = 52 pins  
PAG = 64 pins (FB only)  
PM = 64 pins  
PN = 80 pins  
PCA, PZ = 100 pins (FB only)  
PCB = 120 pins (FIFOs only)

#### SOP (small-outline package)

PS = 8 pins  
NS = 14/16/20/24 pins

#### QSOP (quarter-size small-outline package)

DBQ = 16/20/24 pins

#### SSOP (shrink small-outline package)

DCT = 8 pins  
DB = 14/16/20/24/28/30/38 pins  
DBQ = 16/20/24 pins  
DL = 28/48/56 pins

#### TSSOP (thin shrink small-outline package)

PW = 8/14/16/20/24/28 pins  
DGG = 48/56/64 pins

#### TVSOP (thin very small-outline package)

DGV = 14/16/20/24/48/56 pins  
DBB = 80/100 pins

#### VSSOP (very thin shrink small-outline package)

DCU = 8 pins



## **CBT**

### **Crossbar Technology Logic**

Power and speed are two primary concerns in today's computing market. CBT can address these issues in bus-interface applications. CBT enables a bus-interface device to function as a very fast bus switch, effectively isolating buses when the switch is open and offering very little propagation delay when the switch is closed. These devices can function as high-speed bus interfaces between computer-system components, such as the central processing unit (CPU) and memory. CBT devices also can be used as 5-V to 3.3-V translators, allowing designers to mix 5-V or 3.3-V components in the same system. In addition, the new CBTxxxxC devices provide undershoot protection on all ports down to  $-2$  V.

The CBT devices are available in advanced packaging, such as the quad flatpack no-lead (QFN) package, small-outline integrated circuit (SOIC), small-outline transistor (SOT), quarter-size small-outline package (QSOP), shrink small-outline package (SSOP), thin shrink small-outline package (TSSOP), and thin very small-outline package (TVSOP) for reduced board area. Selected devices are offered in MicroStar BGA™ (LFBGA) and MicroStar Jr.™ (VFBGA) packages.

See [www.ti.com/sc/logic](http://www.ti.com/sc/logic) for the most current data sheets.

# DEVICE SELECTION GUIDE

## CBT

DEVICE	NO. PINS	DESCRIPTION	AVAILABILITY										LITERATURE REFERENCE		
			MIL	LFPGA	QFN	QSOP	SOIC	SOT	SSOP	TSSOP	TVSOP	VFPGA			
SN74CBT1G125	5	Single FET Bus Switches						✓							SCDS046
SN74CBTD1G125	5	Single FET Bus Switches with Level Shifting						✓							SCDS063
SN74CBT1G384	5	Single FET Bus Switches						✓							SCDS065
SN74CBTD1G384	5	Single FET Bus Switches with Level Shifting						✓							SCDS066
SN74CBT3125	14/16	Quad FET Bus Switches			✓	✓	✓			✓	✓	✓			SCDS021
SN74CBT3125C	14/16	Quad FET Bus Switches with Improved Undershoot Protection			+	+	+			+	+	+			Call
SN74CBT3126	14/16	Quad FET Bus Switches			✓	✓	✓			✓	✓	✓			SCDS020
SN74CBT3244	20	Octal FET Bus Switches			✓	✓	✓			✓	✓	✓	✓		SCDS001
SN74CBT3245A	20	Octal FET Bus Switches			✓	✓	✓			✓	✓	✓	✓		SCDS002
SN74CBT3251	16	1-of-8 FET Multiplexers/Demultiplexers			✓	✓	✓			✓	✓				SCDS019
SN74CBT3253	16	Dual 1-of-4 FET Multiplexers/Demultiplexers			✓	✓	✓			✓	✓				SCDS018
SN74CBT3257	16	4-Bit 1-of-2 FET Multiplexers/Demultiplexers			✓	✓	✓			✓	✓				SCDS017
SN74CBT3257C	16	4-Bit 1-of-2 FET Multiplexers/Demultiplexers with Improved Undershoot Protection			+	+	+			+	+				Call
SN74CBT3306	8	Dual FET Bus Switches						✓				✓			SCDS016
SN74CBTD3306	8	Dual FET Bus Switches with Level Shifting						✓				✓			SCDS030
SN74CBTS3306	8	Dual FET Bus Switches with Schottky Diode Clamping						✓				✓			SCDS029
SN74CBT3345	20	8-Bit FET Bus Switches					✓	✓		✓	✓	✓			SCDS027
SN74CBT3383	24	10-Bit FET Bus-Exchange Switches	✓				✓	✓		✓	✓	✓			SCDS003
SN74CBT3384A	24	10-Bit FET Bus Switches					✓	✓		✓	✓	✓			SCDS004
SN74CBTD3384	24	10-Bit FET Bus Switches with Level Shifting					✓	✓		✓	✓	✓			SCDS025
SN74CBTS3384	24	10-Bit FET Bus Switches with Schottky Diode Clamping					✓	✓		✓	✓	✓			SCDS024
SN74CBT3861	24	10-Bit FET Bus Switches					✓	✓		✓	✓	✓			SCDS061
SN74CBTD3861	24	10-Bit FET Bus Switches with Level Shifting					✓	✓		✓	✓	✓			SCDS084

### commercial package description and availability

#### DSBGA (die-size ball grid array)†

YEA, YZA = 5/6/8 pins  
YEP, YZP = 5/6/8 pins

#### LFPGA (low-profile fine-pitch ball grid array)

GGM = 80/100 pins  
GKE, ZKE = 96 pins  
GKF, ZKF = 114 pins

#### VFPGA (very-thin-profile fine-pitch ball grid array)

GQN, ZQN = 20 pins  
GQL, ZQL = 56 pins (also includes 48-pin functions)

#### schedule

✓ = Now    + = Planned

#### PDIP (plastic dual-in-line package)

P = 8 pins  
N = 14/16/20/24 pins  
NT = 24/28 pins

#### PLCC (plastic leaded chip carrier)

FN = 20/28/44/68/84 pins

#### SOIC (small-outline integrated circuit)

D = 8/14/16 pins  
DW = 16/18/20/24/28 pins

#### SOT (small-outline transistor)

PK = 3 pins  
DBV = 3/4/5 pins  
DCY = 4 pins  
DCK = 5/6 pins

#### QFN (quad flatpack no lead)

RGY = 14/16/20 pins  
RGQ = 56 pins

#### QFP (quad flatpack)

RC = 52 pins (FB only)  
PH = 80 pins (FIFOs only)  
PQ = 100/132 pins (FIFOs only)

#### LQFP (low-profile quad flatpack)

PZA = 80 pins

#### TQFP (plastic thin quad flatpack)

PAH = 52 pins  
PAG = 64 pins (FB only)  
PM = 64 pins  
PN = 80 pins  
PCA, PZ = 100 pins (FB only)  
PCB = 120 pins (FIFOs only)

#### SOP (small-outline package)

PS = 8 pins  
NS = 14/16/20/24 pins

#### QSOP (quarter-size small-outline package)

DBQ = 16/20/24 pins

#### SSOP (shrink small-outline package)

DCT = 8 pins  
DB = 14/16/20/24/28/30/38 pins  
DBQ = 16/20/24 pins  
DL = 28/48/56 pins

#### TSSOP (thin shrink small-outline package)

PW = 8/14/16/20/24/28 pins  
DGG = 48/56/64 pins

#### TVSOP (thin very small-outline package)

DGV = 14/16/20/24/48/56 pins  
DBB = 80/100 pins

#### VSSOP (very thin shrink small-outline package)

DCU = 8 pins

† JEDEC reference for wafer chip scale package (WCSP)



DEVICE	NO. PINS	DESCRIPTION	AVAILABILITY										LITERATURE REFERENCE	
			MIL	LFBGA	QFN	QSOP	SOIC	SOT	SSOP	TSSOP	TVSOP	VFBGA		
SN74CBT6800A	24	10-Bit FET Bus Switches with Precharged Outputs for Live Insertion				✓	✓		✓	✓	✓			SCDS005
SN74CBTK6800	24	10-Bit FET Bus Switches with Precharged Outputs and Active-Clamp Undershoot-Protection Circuit				✓	✓		✓	✓	✓			SCDS107
SN74CBTS6800	24	10-Bit FET Bus Switches with Precharged Outputs and Diode Clamping				✓	✓		✓	✓	✓			SCDS102
SN74CBT16209A	48	18-Bit FET Bus-Exchange Switches	✓						✓	✓	✓			SCDS006
SN74CBT16210	48	20-Bit FET Bus Switches							✓	✓	✓			SCDS033
SN74CBTD16210	48	20-Bit FET Bus Switches							✓	✓	✓			SCDS049
SN74CBT16211A	56	24-Bit FET Bus Switches							✓	✓	✓	✓		SCDS028
SN74CBTD16211	56	24-Bit FET Bus Switches with Level Shifting							✓	✓	✓			SCDS048
SN74CBTH16211	56	24-Bit FET Bus Switches with Bus Hold							✓	✓	✓			SCDS062
SN74CBTS16211	56	24-Bit FET Bus Switches with Schottky Diode Clamping							✓	✓	✓			SCDS050
SN74CBT16212A	56	24-Bit FET Bus-Exchange Switches	✓						✓	✓	✓	✓		SCDS007
SN74CBTS16212	56	24-Bit FET Bus-Exchange Switches with Schottky Diode Clamping							✓	✓	✓			SCDS036
SN74CBT16213	56	24-Bit FET Bus-Exchange Switches							✓	✓				SCDS026
SN74CBT16214	56	12-Bit 1-of-3 FET Multiplexers/Demultiplexers							✓	✓				SCDS008
SN74CBT16214C	56	12-Bit 1-of-3 FET Multiplexers/Demultiplexers with Improved Undershoot Protection								+	+			Call
SN74CBT16232	56	Synchronous 16-Bit 1-of-2 FET Multiplexers/Demultiplexers							✓	✓				SCDS009
SN74CBT16233	56	16-Bit 1-of-2 FET Multiplexers/Demultiplexers							✓	✓	✓			SCDS010
SN74CBT16244	48	16-Bit FET Bus Switches	✓						✓	✓	✓			SCDS031
SN74CBT16245	48	16-Bit FET Bus Switches							✓	✓	✓			SCDS070
SN74CBTK16245	48	16-Bit FET Bus Switches with Active-Clamp Undershoot-Protection Circuit							✓	✓	✓			SCDS105
SN74CBT16292	56	12-Bit 1-of-2 FET Multiplexers/Demultiplexers with Internal Pulldown Resistors							✓	✓	✓			SCDS053
SN74CBT16390	56	16-Bit to 32-Bit FET Multiplexer/Demultiplexer Bus Switches							✓	✓	✓			SCDS035
SN74CBT16861	48	20-Bit FET Bus Switches							✓	✓	✓	+		SCDS068
SN74CBTR16861	48	20-Bit FET Bus Switches with Series Damping Resistors							✓	✓	✓			SCDS078
SN74CBT32245	96	32-Bit FET Bus Switches		✓										SCDS104
SN74CBTK32245	96	32-Bit FET Bus Switches with Active-Clamp Undershoot-Protection Circuit		✓										SCDS106

# DEVICE SELECTION GUIDE

## CBT

---

DEVICE	NO. PINS	DESCRIPTION	AVAILABILITY									LITERATURE REFERENCE		
			MIL	LFBGA	QFN	QSOP	SOIC	SOT	SSOP	TSSOP	TVSOP		VFBGA	
SN74CBT162292	56	12-Bit 1-of-2 Multiplexers/Demultiplexers with Internal Pulldown Resistors								✓	✓	✓		SCDS052
SN74CBT34X245	80	32-Bit FET Bus Switches											✓	SCDS089

---

## **CBTLV**

### **Low-Voltage Crossbar Technology Logic**

TI developed the SN74CBTLV family of 3.3-V bus switches to complement its existing SN74CBT family of 5-V bus switches. TI was the first to offer these devices, designed for 3.3 V, in its continuing drive to provide low-voltage solutions.

CBTLV devices can be used in multiprocessor systems as fast bus connections, bus-exchange switches for crossbar systems, ping-pong memory connections, or bus-byte swapping. They also can be used to replace relays, improving connect/disconnect speed and eliminating relay reliability problems. The CBTLV family, designed to operate at 3.3 V, furthers the goal of an integrated system operating with LVTTTL voltages.

The CBTLV devices are available in industry-leading packaging options, such as the small-outline integrated circuit (SOIC), small-outline transistor (SOT), small-outline package (SOP), quarter-size small-outline package (QSOP), shrink small-outline package (SSOP), thin small-outline package (TSSOP), and thin very small-outline package (TVSOP) for reduced board area.

See [www.ti.com/sc/logic](http://www.ti.com/sc/logic) for the most current data sheets.



# DEVICE SELECTION GUIDE

## CBTLV

DEVICE	NO. PINS	DESCRIPTION	AVAILABILITY							LITERATURE REFERENCE		
			QFN	QSOP	SOIC	SOP	SOT	SSOP	TSSOP		TVSOP	
SN74CBTLV1G125	5	Single FET Bus Switches					✓				SCDS057	
SN74CBTLV3125	14/16	Quad FET Bus Switches	✓	✓	✓	✓			✓	✓	✓	SCDS037
SN74CBTLV3126	14/16	Quad FET Bus Switches	✓	✓	✓				✓	✓	✓	SCDS038
SN74CBTLV3245A	20	Octal FET Bus Switches	✓	✓	✓	✓				✓	✓	SCDS034
SN74CBTLV3251	16	1-of-8 FET Multiplexers/Demultiplexers	✓	✓	✓				✓	✓	✓	SCDS054
SN74CBTLV3253	16	Dual 1-of-4 FET Multiplexers/Demultiplexers	✓	✓	✓				✓	✓	✓	SCDS039
SN74CBTLV3257	16	4-Bit 1-of-2 FET Multiplexers/Demultiplexers	✓	✓	✓				✓	✓	✓	SCDS040
SN74CBTLV3383	24	10-Bit FET Bus-Exchange Switches		✓	✓				✓	✓	✓	SCDS047
SN74CBTLV3384	24	10-Bit FET Bus Switches		✓	✓				✓	✓	✓	SCDS059
SN74CBTLV3857	24	10-Bit FET Bus Switches with Internal Pulldown Resistors		✓	✓				✓	✓	✓	SCDS085
SN74CBTLV3861	24	10-Bit FET Bus Switches		✓	✓	✓				✓	✓	SCDS041
SN74CBTLV16210	48	20-Bit FET Bus Switches							✓	✓	✓	SCDS042
SN74CBTLV16211	56	24-Bit FET Bus Switches							✓	✓	✓	SCDS043
SN74CBTLV16212	56	24-Bit FET Bus-Exchange Switches							✓	✓	✓	SCDS044
SN74CBTLV16292	56	12-Bit 1-of-2 FET Multiplexers/Demultiplexers with Internal Pulldown Resistors							✓	✓	✓	SCDS055
SN74CBTLVR16292	56	12-Bit 1-of-2 FET Multiplexers/Demultiplexers with Internal Pulldown Resistors							✓	✓		SCDS056
SN74CBTLV16800	48	20-Bit FET Bus Switches with Precharged Outputs							✓	✓	✓	SCDS045

### commercial package description and availability

#### DSBGA (die-size ball grid array)†

YEA, YZA = 5/6/8 pins  
YEP, YZP = 5/6/8 pins

#### LFGBA (low-profile fine-pitch ball grid array)

GGM = 80/100 pins  
GKE, ZKE = 96 pins  
GKF, ZKF = 114 pins

#### VFBGA (very-thin-profile fine-pitch ball grid array)

GQN, ZQN = 20 pins  
GQL, ZQL = 56 pins (also includes 48-pin functions)

#### schedule

✓ = Now    ✚ = Planned

#### PDIP (plastic dual-in-line package)

P = 8 pins  
N = 14/16/20/24 pins  
NT = 24/28 pins

#### PLCC (plastic leaded chip carrier)

FN = 20/28/44/68/84 pins

#### SOIC (small-outline integrated circuit)

D = 8/14/16 pins  
DW = 16/18/20/24/28 pins

#### SOT (small-outline transistor)

PK = 3 pins  
DBV = 3/4/5 pins  
DCY = 4 pins  
DCK = 5/6 pins

#### QFN (quad flatpack no lead)

RGY = 14/16/20 pins  
RGQ = 56 pins

#### QFP (quad flatpack)

RC = 52 pins (FB only)  
PH = 80 pins (FIFOs only)  
PQ = 100/132 pins (FIFOs only)

#### LQFP (low-profile quad flatpack)

PZA = 80 pins

#### TQFP (plastic thin quad flatpack)

PAH = 52 pins  
PAG = 64 pins (FB only)  
PM = 64 pins  
PN = 80 pins  
PCA, PZ = 100 pins (FB only)  
PCB = 120 pins (FIFOs only)

#### SOP (small-outline package)

PS = 8 pins  
NS = 14/16/20/24 pins

#### QSOP (quarter-size small-outline package)

DBQ = 16/20/24 pins

#### SSOP (shrink small-outline package)

DCT = 8 pins  
DB = 14/16/20/24/28/30/38 pins  
DBQ = 16/20/24 pins  
DL = 28/48/56 pins

#### TSSOP (thin shrink small-outline package)

PW = 8/14/16/20/24/28 pins  
DGG = 48/56/64 pins

#### TVSOP (thin very small-outline package)

DGV = 14/16/20/24/48/56 pins  
DBB = 80/100 pins

#### VSSOP (very thin shrink small-outline package)

DCU = 8 pins

† JEDEC reference for wafer chip scale package (WCSP)

## **CD4000**

### **CMOS B-Series Integrated Circuits**

The CD4000 family is a CMOS B series of devices, with a maximum dc supply-voltage rating of 20 V. The family has a large number of functions, including analog switches, monostable multivibrators, level converters, counters, timers, display drivers, phase-locked loops (PLLs), and other functions. The wide operating voltage range of this family allows use of the CD4000 products in varied applications, including instrumentation, control, and communications.

Key features:

- Wide variety of functions
- High noise immunity
- Low power consumption
- Propagation delay time similar to LSTTL products
- 5-, 10-, and 15-V parametric ratings
- High fanout, typically 10
- Excellent temperature stability

TI's CD4000 products were acquired from Harris Semiconductor in December 1998.

See [www.ti.com/sc/logic](http://www.ti.com/sc/logic) for the most current data sheets.

# DEVICE SELECTION GUIDE

## CD4000

DEVICE	NO. PINS	DESCRIPTION	AVAILABILITY					LITERATURE REFERENCE
			MIL	PDIP	SOIC	SOP	TSSOP	
CD4001B	14	Quad 2-Input NOR Gates	✓	✓	✓	✓	✓	SCHS015
CD4001UB	14	Quad 2-Input Unbuffered NOR Gates	✓	✓	✓	✓	✓	SCHS016
CD4002B	14	Dual 4-Input NOR Gates	✓	✓	✓	✓	✓	SCHS015
CD4007UB	14	Dual Unbuffered Complementary Pairs Plus Inverter	✓	✓	✓	✓	✓	SCHS018
CD4009UB	16	Hex Inverting Buffers/Converters	✓	✓	✓	✓	✓	SCHS020
CD4010B	16	Hex Buffers/Converters		✓		✓	✓	SCHS020
CD4010UB	16	Hex Buffers/Converters	✓					Call
CD4011B	14	Quad 2-Input NAND Gates	✓	✓	✓	✓	✓	SCHS021
CD4011UB	14	Quad 2-Input Unbuffered NAND Gates	✓	✓	✓	✓	✓	SCHS022
CD4012B	14	Dual 4-Input NAND Gates	✓	✓	✓	✓	✓	SCHS021
CD4013B	14	Dual D-Type Flip-Flops	✓	✓	✓	✓	✓	SCHS023
CD4014B	16	8-Stage Static Shift Registers	✓	✓	✓	✓	✓	SCHS024
CD4015B	16	Dual 4-Stage Static Shift Registers	✓	✓		✓	✓	SCHS025
CD4016B	14	Quad Bilateral Switches	✓	✓	✓	✓	✓	SCHS026
CD4017B	16	Decade Counters/Dividers with 1-of-10 Decoded Outputs	✓	✓		✓	✓	SCHS027
CD4018B	16	Divide-by-N Counters	✓	✓	✓	✓	✓	SCHS028
CD4019B	16	Quad AND/OR Select Gates	✓	✓	✓	✓	✓	SCHS029
CD4020B	16	12-Stage Ripple-Carry Binary Counters/Dividers	✓	✓		✓	✓	SCHS030
CD4021B	16	8-Stage Static Shift Registers	✓	✓		✓	✓	SCHS024
CD4022B	16	Octal Counters/Dividers with 1-of-8 Decoded Outputs	✓	✓		✓	✓	SCHS027
CD4023B	14	Triple 3-Input NAND Gates	✓	✓	✓	✓	✓	SCHS021
CD4024B	14	7-Stage Ripple-Carry Binary Counters/Dividers	✓	✓	✓	✓	✓	SCHS030
CD4025B	14	Triple 3-Input NOR Gates	✓	✓	✓	✓	✓	SCHS015
CD4026B	16	Decade Counters/Drivers with Decoded 7-Segment Display Outputs	✓	✓		✓	✓	SCHS031
CD4027B	16	Dual J-K Master-Slave Flip-Flops	✓	✓	✓	✓	✓	SCHS032
CD4028B	16	BCD-to-Decimal Decoders	✓	✓		✓	✓	SCHS033
CD4029B	16	Presetable Up/Down Binary or BCD-Decade Counters	✓	✓	✓	✓	✓	SCHS034
CD4030B	14	Quad Exclusive-OR Gates	✓	✓	✓	✓	✓	SCHS035
CD4031B	16	64-Stage Static Shift Registers	✓	✓		✓	✓	SCHS036
CD4033B	16	Decade Counters/Drivers with Decoded 7-Segment Display Outputs	✓	✓		✓	✓	SCHS031
CD4034B	24	8-Stage Static Bidirectional Parallel/Serial Input/Output Bus Registers	✓	✓	✓	✓	✓	SCHS037
CD4035B	16	4-Stage Parallel-In/Parallel-Out Shift Registers	✓	✓	✓	✓	✓	SCHS038
CD4040B	16	12-Stage Ripple-Carry Binary Counters/Dividers	✓	✓		✓	✓	SCHS030
CD4041UB	14	Quad True/Complement Buffers	✓	✓	✓	✓	✓	SCHS039
CD4042B	16	Quad Clocked D Latches	✓	✓	✓	✓	✓	SCHS040
CD4043B	16	Quad NOR R/S Latches with 3-State Outputs	✓	✓	✓	✓	✓	SCHS041
CD4044B	16	Quad NAND R/S Latches with 3-State Outputs	✓	✓	✓	✓	✓	SCHS041
CD4045B	16	21-Stage Counters	✓	✓		✓	✓	SCHS042
CD4046B	16	Micropower Phase-Locked Loops with VCO	✓	✓		✓	✓	SCHS043
CD4047B	14	Low-Power Monostable/Astable Multivibrators	✓	✓	✓	✓	✓	SCHS044

### commercial package description and availability

#### schedule

- ✓ = Now
- + = Planned

See Appendix A for package information.



DEVICE	NO. PINS	DESCRIPTION	AVAILABILITY					LITERATURE REFERENCE
			MIL	PDIP	SOIC	SOP	TSSOP	
CD4048B	16	Multifunction Expandable 8-Input Gates	✓	✓	✓	✓	✓	SCHS045
CD4049UB	16	Hex Buffers/Converters	✓	✓	✓	✓	✓	SCHS046
CD4050B	16	Hex Buffers/Converters	✓	✓	✓	✓	✓	SCHS046
CD4051B	16	8-Channel Analog Multiplexers/Demultiplexers with Logic-Level Conversion	✓	✓	✓	✓	✓	SCHS047
CD4052B	16	Dual 4-Channel Analog Multiplexers/Demultiplexers with Logic-Level Conversion	✓	✓	✓	✓	✓	SCHS047
CD4053B	16	Triple 2-Channel Analog Multiplexers/Demultiplexers with Logic-Level Conversion	✓	✓	✓	✓	✓	SCHS047
CD4054B	16	4-Segment Liquid Crystal Display Drivers	✓	✓	✓	✓	✓	SCHS048
CD4055B	16	BCD to 7-Segment Liquid Crystal Decoders/Drivers with Display-Frequency Output	✓	✓	✓	✓	✓	SCHS048
CD4056B	16	BCD to 7-Segment Liquid Crystal Decoders/Drivers with Strobed Latch Function	✓	✓	✓	✓	✓	SCHS048
CD4059A	24	Programmable Divide-by-N Counters	✓	✓	✓			SCHS109
CD4060B	16	14-Stage Binary-Ripple Counters/Dividers and Oscillator	✓	✓	✓	✓	✓	SCHS049
CD4063B	16	4-Bit Magnitude Comparators	✓	✓	✓	✓	✓	SCHS050
CD4066B	14	Quad Bilateral Switches	✓	✓	✓	✓	✓	SCHS051
CD4067B	24	Single 16-Channel Analog Multiplexers/Demultiplexers	✓	✓	✓	✓	✓	SCHS052
CD4068B	14	8-Input NAND/AND Gates	✓	✓	✓	✓	✓	SCHS053
CD4069UB	14	Hex Inverters	✓	✓	✓	✓	✓	SCHS054
CD4070B	14	Quad Exclusive-OR Gates	✓	✓	✓	✓	✓	SCHS055
CD4071B	14	Quad 2-Input OR Gates	✓	✓	✓	✓	✓	SCHS056
CD4072B	14	Dual 4-Input OR Gates	✓	✓	✓	✓	✓	SCHS056
CD4073B	14	Triple 3-Input AND Gates	✓	✓	✓	✓	✓	SCHS057
CD4075B	14	Triple 3-Input OR Gates	✓	✓	✓	✓	✓	SCHS056
CD4076B	16	4-Bit D-Type Registers	✓	✓	✓	✓	✓	SCHS058
CD4077B	14	Quad Exclusive-NOR Gates	✓	✓	✓	✓	✓	SCHS055
CD4078B	14	8-Input NOR/OR Gates	✓	✓	✓	✓	✓	SCHS059
CD4081B	14	Quad 2-Input AND Gates	✓	✓	✓	✓	✓	SCHS057
CD4082B	14	Dual 4-Input AND Gates	✓	✓	✓	✓	✓	SCHS057
CD4085B	14	Dual 2-Wide 2-Input AND-OR-Invert Gates	✓	✓	✓	✓	✓	SCHS060
CD4086B	14	Expandable 4-Wide 2-Input AND-OR-Invert Gates	✓	✓	✓	✓	✓	SCHS061
CD4089B	16	4-Bit Binary Rate Multipliers	✓	✓		✓	✓	SCHS062
CD4093B	14	Quad 2-Input NAND Schmitt Triggers	✓	✓	✓	✓	✓	SCHS115
CD4094B	16	8-Stage Shift-and-Store Bus Registers	✓	✓		✓	✓	SCHS063
CD4097B	24	Differential 8-Channel Analog Multiplexers/Demultiplexers	✓	✓	✓	✓	✓	SCHS052
CD4098B	16	Dual Monostable Multivibrators	✓	✓			✓	SCHS065
CD4099B	16	8-Bit Addressable Latches	✓	✓		✓	✓	SCHS066
CD4502B	16	Strobed Hex Inverters/Buffers	✓	✓		✓	✓	SCHS067
CD4503B	16	Hex Buffers	✓	✓	✓	✓	✓	SCHS068
CD4504B	16	Hex Voltage-Level Shifters for TTL-to-CMOS or CMOS-to-CMOS Operation	✓	✓			✓	SCHS069
CD4508B	24	Dual 4-Bit Latches	✓	✓	✓	✓	✓	SCHS070
CD4510B	16	Presetable BCD Up/Down Counters	✓	✓		✓	✓	SCHS071
CD4511B	16	BCD to 7-Segment Latch Decoder Drivers	✓	✓		✓	✓	SCHS072
CD4512B	16	8-Channel Data Selectors	✓	✓	✓	✓	✓	SCHS073
CD4514B	24	4-Bit Latches/4-to-16 Line Decoders	✓	✓	✓			SCHS074
CD4515B	24	4-Bit Latches/4-to-16 Line Decoders	✓	✓	✓			SCHS074
CD4516B	16	Presetable Binary Up/Down Counters	✓	✓		✓	✓	SCHS071

# DEVICE SELECTION GUIDE

## CD4000

DEVICE	NO. PINS	DESCRIPTION	AVAILABILITY					LITERATURE REFERENCE
			MIL	PDIP	SOIC	SOP	TSSOP	
CD4517B	16	Dual 64-Stage Static Shift Registers	✓	✓				SCHS075
CD4518B	16	Dual BCD Up Counters	✓	✓		✓	✓	SCHS076
CD4520B	16	Dual Binary Up Counters	✓	✓		✓	✓	SCHS076
CD4521B	16	24-Stage Frequency Dividers	✓	✓		✓	✓	SCHS078
CD4522B	16	Programmable BCD Divide-by-N Counters	✓	✓	✓	✓	✓	SCHS079
CD4527B	16	BCD Rate Multipliers	✓	✓		✓	✓	SCHS080
CD4532B	16	8-Bit Priority Encoders	✓	✓	✓	✓	✓	SCHS082
CD4536B	16	Programmable Timers	✓	✓	✓	✓	✓	SCHS083
CD4541B	14	Programmable Timers	✓	✓	✓	✓	✓	SCHS085
CD4543B	16	BCD to 7-Segment Latches/Decoders/Drivers for Liquid-Crystal Displays	✓	✓	✓	✓	✓	SCHS086
CD4555B	16	Dual Binary 1-of-4 Decoders/Demultiplexers	✓	✓	✓	✓	✓	SCHS087
CD4556B	16	Dual Binary 1-of-4 Decoders/Demultiplexers	✓	✓	✓			SCHS087
CD4572UB	16	Hex Gates (4 Inverters, 2-Input NOR, 2-Input NAND)	✓	✓	✓	✓	✓	SCHS090
CD4585B	16	4-Bit Magnitude Comparators	✓	✓		✓	✓	SCHS091
CD4724B	16	8-Bit Addressable Latches	✓	✓		✓	✓	SCHS092
CD14538B	16	Dual-Precision Monostable Multivibrators	✓	✓	✓	✓	✓	SCHS093
CD40102B	16	2-Decade BCD Presettable Synchronous Down Counters	✓	✓		✓	✓	SCHS095
CD40103B	16	8-Bit Binary Presettable Synchronous Down Counters	✓	✓		✓	✓	SCHS095
CD40106B	14	Hex Schmitt Triggers	✓	✓	✓	✓	✓	SCHS096
CD40107B	8	Dual 2-Input NAND Buffers/Drivers	✓	✓		✓	✓	SCHS097
CD40109B	16	Quad Low- to High-Voltage Level Shifters	✓	✓	✓	✓	✓	SCHS098
CD40110B	16	Decade Up-Down Counters/Latches/7-Segment Display Drivers	✓	✓				SCHS099
CD40117B	14	Programmable Dual 4-Bit Terminators	✓	✓	✓	✓	✓	SCHS100
CD40147B	16	10-Line to 4-Line BCD Priority Encoders	✓	✓	✓	✓	✓	SCHS102
CD40161B	16	Programmable 4-Bit Binary Counters with Asynchronous Clear	✓	✓		✓	✓	SCHS103
CD40174B	16	Hex D-Type Flip-Flops	✓	✓	✓	✓	✓	SCHS104
CD40175B	16	Quad D-Type Flip-Flops	✓	✓	✓	✓	✓	SCHS105
CD40192B	16	Presettable Binary Up/Down Counters with Dual Clock and Reset	✓	✓		✓	✓	SCHS106
CD40193B	16	Presettable Binary Up/Down Counters with Dual Clock and Reset	✓	✓		✓	✓	SCHS106
CD40194B	16	4-Bit Bidirectional Universal Shift Registers		✓		✓	✓	SCHS107
CD40257B	16	Quad 2-Line to 1-Line Data Selectors/Multiplexers	✓	✓	✓	✓	✓	SCHS108

## **74F**

### **Fast Logic**

74F logic is a general-purpose family of high-speed advanced bipolar logic. TI provides over 50 functions in the 74F family, including gates, buffers/drivers, bus transceivers, flip-flops, latches, counters, multiplexers, and demultiplexers.

See [www.ti.com/sc/logic](http://www.ti.com/sc/logic) for the most current data sheets.

# DEVICE SELECTION GUIDE

## 74F

DEVICE	NO. PINS	DESCRIPTION	AVAILABILITY					LITERATURE REFERENCE
			MIL	PDIP	SOIC	SOP	SSOP	
SN74F00	14	Quad 2-Input NAND Gates	✓	✓	✓	✓		SDFS035
SN74F02	14	Quad 2-Input NOR Gates	✓	✓	✓	✓		SDFS036
SN74F04	14	Hex Inverters	✓	✓	✓	✓		SDFS037
SN74F08	14	Quad 2-Input AND Gates		✓	✓	✓	✓	SDFS038
SN74F10	14	Triple 3-Input NAND Gates	✓	✓	✓	✓		SDFS039
SN74F11	14	Triple 3-Input AND Gates	✓	✓	✓	✓		SDFS040
SN74F20	14	Dual 4-Input NAND Gates	✓	✓	✓	✓		SDFS041
SN74F21	14	Dual 4-Input AND Gates		✓	✓			SDFS006
SN74F27	14	Triple 3-Input NOR Gates	✓	✓	✓	✓		SDFS042
SN74F30	14	8-Input NAND Gates	✓	✓	✓	✓		SDFS043
SN74F32	14	Quad 2-Input OR Gates	✓	✓	✓	✓		SDFS044
SN74F38	14	Quad 2-Input NAND Gates	✓	✓	✓	✓		SDFS013
SN74F74	14	Dual D-Type Flip-Flops with Set and Reset	✓	✓	✓	✓		SDFS046
SN74F86	14	Quad 2-Input Exclusive-OR Gates		✓	✓	✓		SDFS019
SN74F109	16	Dual Positive-Edge-Triggered J-K Flip Flops with Set and Reset	✓	✓	✓	✓		SDFS047
SN74F112	16	Dual Negative-Edge-Triggered J-K Flip-Flops with Set and Reset		✓	✓	✓		SDFS048
SN74F125	14	Quad Bus Buffers with 3-State Outputs		✓	✓	✓		SDFS016
SN74F126	14	Quad Bus Buffers with 3-State Outputs		✓	✓	✓		SDFS017
SN74F138	16	3-to-8 Line Inverting Decoders/Demultiplexers	✓	✓	✓	✓		SDFS051
SN74F151B	16	1-of-8 Data Selectors/Multiplexers		✓	✓	✓		SDFS023
SN74F153	16	Dual 1-of-4 Data Selectors/Multiplexers	✓	✓	✓	✓		SDFS052
SN74F157A	16	Quad 2-to-4 Line Data Selectors/Multiplexers	✓	✓	✓	✓		SDFS053
SN74F161A	16	Synchronous 4-Bit Binary Counters		✓	✓	✓	✓	SDFS056
SN74F163A	16	Synchronous 4-Bit Binary Counters		✓	✓	✓	✓	SDFS088
SN74F169	16	Synchronous 4-Bit Up/Down Binary Counters		✓	✓			SDFS089
SN74F174A	16	Hex D-Type Flip-Flops with Clear		✓	✓	✓		SDFS029
SN74F175	16	Quad D-Type Flip-Flops with Clear		✓	✓	✓		SDFS058
SN74F240	20	Octal Buffers/Drivers with 3-State Outputs	✓	✓	✓	✓	✓	SDFS061
SN74F241	20	Octal Buffers/Drivers with 3-State Outputs	✓	✓	✓	✓		SDFS090
SN74F244	20	Octal Buffers and Line Drivers with 3-State Outputs	✓	✓	✓	✓	✓	SDFS063
SN74F245	20	Octal Bus Transceivers with 3-State Outputs	✓	✓	✓	✓	✓	SDFS010
SN74F251B	16	1-of-8 Data Selectors/Multiplexers with 3-State Outputs		✓	✓			SDFS066

### commercial package description and availability

#### DSBGA (die-size ball grid array)†

YEA, YZA = 5/6/8 pins  
YEP, YZP = 5/6/8 pins

#### LFBGA (low-profile fine-pitch ball grid array)

GGM = 80/100 pins  
GKE, ZKE = 96 pins  
GKF, ZKF = 114 pins

#### VFBGA (very-thin-profile fine-pitch ball grid array)

GQN, ZQN = 20 pins  
GQL, ZQL = 56 pins (also includes 48-pin functions)

#### schedule

✓ = Now    ✚ = Planned

#### PDIP (plastic dual-in-line package)

P = 8 pins  
N = 14/16/20/24 pins  
NT = 24/28 pins

#### PLCC (plastic leaded chip carrier)

FN = 20/28/44/68/84 pins

#### SOIC (small-outline integrated circuit)

D = 8/14/16 pins  
DW = 16/18/20/24/28 pins

#### SOT (small-outline transistor)

PK = 3 pins  
DBV = 3/4/5 pins  
DCY = 4 pins  
DCK = 5/6 pins

#### QFN (quad flatpack no lead)

RGY = 14/16/20 pins  
RGQ = 56 pins

#### QFP (quad flatpack)

RC = 52 pins (FB only)  
PH = 80 pins (FIFOs only)  
PQ = 100/132 pins (FIFOs only)

#### LQFP (low-profile quad flatpack)

PZA = 80 pins

#### TQFP (plastic thin quad flatpack)

PAH = 52 pins  
PAG = 64 pins (FB only)  
PM = 64 pins  
PN = 80 pins  
PCA, PZ = 100 pins (FB only)  
PCB = 120 pins (FIFOs only)

#### SOP (small-outline package)

PS = 8 pins  
NS = 14/16/20/24 pins

#### QSOP (quarter-size small-outline package)

DBQ = 16/20/24 pins

#### SSOP (shrink small-outline package)

DCT = 8 pins  
DB = 14/16/20/24/28/30/38 pins  
DBQ = 16/20/24 pins  
DL = 28/48/56 pins

#### TSSOP (thin shrink small-outline package)

PW = 8/14/16/20/24/28 pins  
DGG = 48/56/64 pins

#### TVSOP (thin very small-outline package)

DGV = 14/16/20/24/48/56 pins  
DBB = 80/100 pins

#### VSSOP (very thin shrink small-outline package)

DCU = 8 pins

† JEDEC reference for wafer chip scale package (WCSP)



DEVICE	NO. PINS	DESCRIPTION	AVAILABILITY					LITERATURE REFERENCE
			MIL	PDIP	SOIC	SOP	SSOP	
SN74F253	16	Dual 1-of-4 Data Selectors/Multiplexers with 3-State Outputs		✓	✓	✓		SDFS064
SN74F257	16	Quad 1-of-2 Data Selectors/Multiplexers with 3-State Outputs		✓	✓	✓		SDFS065
SN74F258	16	Quad 1-of-2 Data Selectors/Multiplexers with 3-State Outputs		✓	✓	✓		SDFS067
SN74F260	14	Dual 5-Input NOR Gates		✓	✓	✓		SDFS012
SN74F280B	14	9-Bit Odd/Even Parity Generators/Checkers		✓	✓	✓		SDFS008
SN74F283	16	9-Bit Binary Full Adders with Fast Carry	✓	✓	✓	✓		SDFS069
SN74F299	20	8-Bit Universal Shift/Storage Registers		✓	✓			SDFS071
SN74F373	20	Octal Transparent D-Type Latches with 3-State Outputs	✓	✓	✓	✓	✓	SDFS076
SN74F374	20	Octal Edge-Triggered D-Type Flip-Flops with 3-State Outputs	✓	✓	✓	✓	✓	SDFS077
SN74F377A	20	Octal D-Type Flip-Flops with Enable		✓	✓			SDFS018
SN74F520	20	8-Bit Identity Comparators ( $\overline{P = Q}$ ) with Input Pullup Resistors		✓	✓			SDFS081
SN74F521	20	8-Bit Identity Comparators ( $P = Q$ )	✓	✓	✓	✓		SDFS091
SN74F541	20	Octal Buffers and Line Drivers with 3-State Outputs	✓	✓	✓	✓		SDFS021
SN74F543	24	Octal Registered Transceivers with 3-State Outputs		✓	✓	✓	✓	SDFS025
SN74F573	20	Octal Transparent D-Type Latches with 3-State Outputs		✓	✓			SDFS011
SN74F574	20	Octal Edge-Triggered D-Type Flip-Flops with 3-State Outputs		✓	✓	✓		SDFS005
SN74F623	20	Octal Bus Transceivers with 3-State Outputs	✓	✓	✓			SDFS087
SN74F657	24	Octal Bus Transceivers with Parity Generators/Checkers and 3-State Outputs		✓	✓			SDFS027
SN74F1016	20	16-Bit Schottky Barrier Diode R-C Bus-Termination Arrays			✓			SDFS093
SN74F1056	16	8-Bit Schottky Barrier Diode Bus-Termination Arrays			✓			SDFS085
SN74F2244	20	Octal Buffers/Line Drivers with Series Damping Resistors and 3-State Outputs		✓	✓		✓	SDFS095
SN74F2245	20	Octal Bus Transceivers with Series Damping Resistors and 3-State Outputs		✓	✓		✓	SDFS099
SN74F2373	20	25-Ω Octal Transparent D-Type Latches with 3-State Outputs		✓	✓		✓	SDFS100



## **FB+/BTL**

### **FutureBus+/ Backplane Transceiver Logic**

The FB+ series of devices is designed for use in double-terminated high-speed bus applications and is fully compatible with IEEE Std 896-1991 (FutureBus+) and IEEE Std 1194.1-1991 (BTL). These transceivers are available in 7-, 8-, 9-, and 18-bit versions for 5-V CMOS or TTL-to-BTL and BTL-to-TTL translations. Other features include BTL drive up to 100 mA, low (5 pF to 6 pF maximum) B-port  $C_{iO}$ ,  $t_{pd}$  performance below 5 ns, and B-port BIAS  $V_{CC}$  pins for live insertion.

One device, the 18-bit 'FB1653, offers 5-V CMOS, TTL- or LVTTTL-to-BTL and BTL-to-LVTTTL translations.

See [www.ti.com/sc/logic](http://www.ti.com/sc/logic) for the most current data sheets.

# DEVICE SELECTION GUIDE

## FB+/BTL

DEVICE	NO. PINS	DESCRIPTION	AVAILABILITY			LITERATURE REFERENCE
			MIL	QFP	TQFP	
SN74FB1650	100	18-Bit TTL/BTL Universal Storage Transceivers			✓	SCBS178
SN74FB1651	100	17-Bit TTL/BTL Universal Storage Transceivers with Buffered Clock Lines			✓	SCBS177
SN74FB1653	100	17-Bit LVTTTL/BTL Universal Storage Transceivers with Buffered Clock Lines			✓	SCBS702
SN74FB2031	52	9-Bit TTL/BTL Address/Data Transceivers	✓	✓		SCBS176
SN74FB2033A	52	8-Bit TTL/BTL Registered Transceivers	✓	✓		SCBS174
SN74FB2033K	52	8-Bit TTL/BTL Registered Transceivers			✓	SCBS472
SN74FB2040	52	8-Bit TTL/BTL Transceivers	✓	✓		SCBS173
SN74FB2041A	52	7-Bit TTL/BTL Transceivers			✓	SCBS172

### commercial package description and availability

#### DSBGA (die-size ball grid array)†

YEA, YZA = 5/6/8 pins  
YEP, YZP = 5/6/8 pins

#### LFPGA (low-profile fine-pitch ball grid array)

GGM = 80/100 pins  
GKE, ZKE = 96 pins  
GKF, ZKF = 114 pins

#### VFPGA (very-thin-profile fine-pitch ball grid array)

GQN, ZQN = 20 pins  
GQL, ZQL = 56 pins (also includes 48-pin functions)

#### schedule

✓ = Now    ✚ = Planned

#### PDIP (plastic dual-in-line package)

P = 8 pins  
N = 14/16/20/24 pins  
NT = 24/28 pins

#### PLCC (plastic leaded chip carrier)

FN = 20/28/44/68/84 pins

#### SOIC (small-outline integrated circuit)

D = 8/14/16 pins  
DW = 16/18/20/24/28 pins

#### SOT (small-outline transistor)

PK = 3 pins  
DBV = 3/4/5 pins  
DCY = 4 pins  
DCK = 5/6 pins

#### QFN (quad flatpack no lead)

RGY = 14/16/20 pins  
RGQ = 56 pins

#### QFP (quad flatpack)

RC = 52 pins (FB only)  
PH = 80 pins (FIFOs only)  
PQ = 100/132 pins (FIFOs only)

#### LQFP (low-profile quad flatpack)

PZA = 80 pins

#### TQFP (plastic thin quad flatpack)

PAH = 52 pins  
PAG = 64 pins (FB only)  
PM = 64 pins  
PN = 80 pins  
PCA, PZ = 100 pins (FB only)  
PCB = 120 pins (FIFOs only)

#### SOP (small-outline package)

PS = 8 pins  
NS = 14/16/20/24 pins

#### QSOP (quarter-size small-outline package)

DBQ = 16/20/24 pins

#### SSOP (shrink small-outline package)

DCT = 8 pins  
DB = 14/16/20/24/28/30/38 pins  
DBQ = 16/20/24 pins  
DL = 28/48/56 pins

#### TSSOP (thin shrink small-outline package)

PW = 8/14/16/20/24/28 pins  
DGG = 48/56/64 pins

#### TVSOP (thin very small-outline package)

DGV = 14/16/20/24/48/56 pins  
DBB = 80/100 pins

#### VSSOP (very thin shrink small-outline package)

DCU = 8 pins

† JEDEC reference for wafer chip scale package (WCSP)



## FCT

### Fast CMOS TTL Logic

The FCT product family is designed for high-current-drive bus-interface applications. The FCT family is fabricated using a CMOS 6- $\mu\text{m}$  technology to provide up to 40-mA or 64-mA current sink capability, with typical propagation delays of 5 ns (CD74FCT245). The family is optimized to operate at 5 V and is pin-function compatible with most standard bipolar and CMOS logic families.

The FCT family of devices has several features for efficient bus interfacing. The family does not have input or output diodes to  $V_{CC}$ , and most FCT devices have 3-state outputs. Bus noise is minimized with 1-V, or less, typical ground bounce ( $V_{olp}$ , 5-V  $V_{CC}$ , 25°C) and limited output voltage swing (3.5 V typical).

The FCT family includes 8-, 9-, and 10-bit bus-interface devices.

Key features:

- 5-V operation
- 5-ns typical propagation delay (CD74FCT245)
- Low quiescent power consumption
- 1-V typical  $V_{olp}$

TI's FCT family was acquired from Harris Semiconductor in December 1998.

See [www.ti.com/sc/logic](http://www.ti.com/sc/logic) for the most current data sheets.

# DEVICE SELECTION GUIDE

## FCT

DEVICE	NO. PINS	DESCRIPTION	AVAILABILITY				LITERATURE REFERENCE	
			MIL	PDIP	QSOP	SOIC		SSOP
CY29FCT52CT	24	Octal Registered Transceivers with 3-State Outputs			✓	✓	✓	SCCS010
CY74FCT138AT	16	1-of-8 Decoders			✓	✓	✓	SCCS013
CY74FCT138CT	16	1-of-8 Decoders	✓		✓	✓	✓	SCCS013
CY74FCT138T	16	1-of-8 Decoders			✓		✓	SCCS013
CY74FCT157AT	16	Quad 2-Input Multiplexers			✓	✓	✓	SCCS014
CY74FCT157CT	16	Quad 2-Input Multiplexers			✓	✓	✓	SCCS014
CY74FCT163CT	16	Synchronous 4-Bit Binary Counters			✓	✓	✓	SCCS015
CY74FCT163T	16	Synchronous 4-Bit Binary Counters	✓					SCCS015
CY74FCT191AT	16	Presetable Synchronous 4-Bit Up/Down Binary Counters				✓		SCCS016
CY74FCT191CT	16	Presetable Synchronous 4-Bit Up/Down Binary Counters			✓	✓	✓	SCCS016
CY74FCT240AT	20	Octal Buffers/Drivers with 3-State Outputs	✓		✓	✓	✓	SCCS017
CY74FCT240CT	20	Octal Buffers/Drivers with 3-State Outputs			✓	✓	✓	SCCS017
CY74FCT240T	20	Octal Buffers/Drivers with 3-State Outputs			✓	✓	✓	SCCS017
CD74FCT244	20	Octal Buffers and Line Drivers with 3-State Outputs		✓		✓		SCHS270
CD74FCT244AT	20	Octal Buffers and Line Drivers with 3-State Outputs		✓				SCHS270
CY74FCT244AT	20	Octal Buffers and Line Drivers with 3-State Outputs	✓	✓	✓	✓		SCCS017
CY74FCT244CT	20	Octal Buffers and Line Drivers with 3-State Outputs	✓		✓	✓	✓	SCCS017
CY74FCT244DT	20	Octal Buffers and Line Drivers with 3-State Outputs			✓	✓	✓	SCCS017
CY74FCT244T	20	Octal Buffers and Line Drivers with 3-State Outputs	✓		✓	✓	✓	SCCS017
CD74FCT245	20	Octal Bus Transceivers with 3-State Outputs		✓		✓		SCHS271
CY74FCT245AT	20	Octal Bus Transceivers with 3-State Outputs	✓	✓	✓	✓	✓	SCCS018
CY74FCT245CT	20	Octal Bus Transceivers with 3-State Outputs	✓		✓	✓	✓	SCCS018
CY74FCT245DT	20	Octal Bus Transceivers with 3-State Outputs			✓		✓	SCCS018
CY74FCT245T	20	Octal Bus Transceivers with 3-State Outputs	✓		✓	✓	✓	SCCS018
CY74FCT257AT	16	Quad 1-of-2 Data Selectors/Multiplexers with 3-State Outputs			✓		✓	SCCS019
CY74FCT257CT	16	Quad 1-of-2 Data Selectors/Multiplexers with 3-State Outputs			✓	✓	✓	SCCS019
CY74FCT257T	16	Quad 1-of-2 Data Selectors/Multiplexers with 3-State Outputs			✓		✓	SCCS019
CD74FCT273	20	Octal D-Type Flip-Flops with Clear		✓		✓		SCHS254
CY74FCT273AT	20	Octal D-Type Flip-Flops with Clear	✓		✓	✓	✓	SCCS020
CY74FCT273CT	20	Octal D-Type Flip-Flops with Clear			✓	✓	✓	SCCS020
CY74FCT273T	20	Octal D-Type Flip-Flops with Clear			✓	✓	✓	SCCS020
CY74FCT373AT	20	Octal Transparent D-Type Latches with 3-State Outputs	✓		✓	✓	✓	SCCS021
CY74FCT373CT	20	Octal Transparent D-Type Latches with 3-State Outputs			✓	✓	✓	SCCS021
CY74FCT373T	20	Octal Transparent D-Type Latches with 3-State Outputs				✓		SCCS021
CD74FCT374	20	Octal Transparent D-Type Latches with 3-State Outputs		✓		✓		SCHS256
CY74FCT374AT	20	Octal Transparent D-Type Latches with 3-State Outputs	✓	✓	✓	✓	✓	SCCS022
CY74FCT374CT	20	Octal Transparent D-Type Latches with 3-State Outputs	✓		✓	✓	✓	SCCS022
CY74FCT374T	20	Octal Transparent D-Type Latches with 3-State Outputs	✓		✓	✓	✓	SCCS022
CY74FCT377AT	20	Octal D-Type Flip-Flops with Enable			✓	✓	✓	SCCS023
CY74FCT377CT	20	Octal D-Type Flip-Flops with Enable	✓		✓	✓	✓	SCCS023
CY74FCT377T	20	Octal D-Type Flip-Flops with Enable			✓		✓	SCCS023

### commercial package description and availability

#### schedule

- ✓ = Now
- ✦ = Planned

See Appendix A for package information.



DEVICE	NO. PINS	DESCRIPTION	AVAILABILITY					LITERATURE REFERENCE
			MIL	PDIP	QSOP	SOIC	SSOP	
CY74FCT399AT	16	Quad 2-Input Multiplexers with Storage				✓	✓	SCCS024
CY74FCT399CT	16	Quad 2-Input Multiplexers with Storage				✓		SCCS024
CY74FCT480AT	24	Dual 8-Bit Parity Generators/Checkers		✓	✓		✓	SCCS025
CY74FCT480BT	24	Dual 8-Bit Parity Generators/Checkers	✓	✓	✓	✓	✓	SCCS025
CY29FCT520AT	24	8-Bit Multi-Level Pipeline Registers		✓		✓		SCCS011
CY29FCT520BT	24	8-Bit Multi-Level Pipeline Registers				✓		SCCS011
CY29FCT520CT	24	8-Bit Multi-Level Pipeline Registers				✓		SCCS011
CD74FCT540	20	Inverting Octal Buffers and Line Drivers with 3-State Outputs		✓		✓		SCHS257
CY74FCT540CT	20	Inverting Octal Buffers and Line Drivers with 3-State Outputs			✓		✓	SCCS029
CD74FCT541	20	Octal Buffers and Line Drivers with 3-State Outputs		✓		✓		SCHS257
CY74FCT541AT	20	Octal Buffers and Line Drivers with 3-State Outputs		✓	✓	✓	✓	SCCS029
CY74FCT541CT	20	Octal Buffers and Line Drivers with 3-State Outputs			✓	✓	✓	SCCS029
CY74FCT541T	20	Octal Buffers and Line Drivers with 3-State Outputs				✓		SCCS029
CD74FCT543	24	Octal Registered Transceivers with 3-State Outputs		✓		✓		SCHS258
CY74FCT543AT	24	Octal Registered Transceivers with 3-State Outputs			✓	✓	✓	SCCS030
CY74FCT543CT	24	Octal Registered Transceivers with 3-State Outputs			✓	✓	✓	SCCS030
CY74FCT543T	24	Octal Registered Transceivers with 3-State Outputs	✓		✓	✓	✓	SCCS030
CD74FCT564	20	Octal Inverting D-Type Flip-Flops with 3-State Outputs		✓		✓		SCHS259
CD74FCT573	20	Octal Transparent D-Type Latches with 3-State Outputs		✓	✓	✓	✓	SCHS260
CD74FCT573AT	20	Octal Transparent D-Type Latches with 3-State Outputs		✓				SCHS260
CY74FCT573AT	20	Octal Transparent D-Type Latches with 3-State Outputs		✓	✓	✓	✓	SCCS021
CY74FCT573CT	20	Octal Transparent D-Type Latches with 3-State Outputs			✓	✓	✓	SCCS021
CY74FCT573T	20	Octal Transparent D-Type Latches with 3-State Outputs			✓	✓	✓	SCCS021
CD74FCT574	20	Octal Edge-Triggered D-Type Flip-Flops with 3-State Outputs		✓		✓		SCHS259
CY74FCT574AT	20	Octal Edge-Triggered D-Type Flip-Flops with 3-State Outputs	✓		✓	✓	✓	SCCS022
CY74FCT574CT	20	Octal Edge-Triggered D-Type Flip-Flops with 3-State Outputs			✓	✓	✓	SCCS022
CY74FCT574T	20	Octal Edge-Triggered D-Type Flip-Flops with 3-State Outputs			✓	✓	✓	SCCS022
CD74FCT623	20	Octal Bus Transceivers with 3-State Outputs				✓		SCHS296
CY74FCT646AT	24	Octal Registered Bus Transceivers with 3-State Outputs			✓	✓	✓	SCCS031
CY74FCT646CT	24	Octal Registered Bus Transceivers with 3-State Outputs	✓		✓	✓	✓	SCCS031
CY74FCT646T	24	Octal Registered Bus Transceivers with 3-State Outputs			✓	✓	✓	SCCS031
CY74FCT652AT	24	Octal Bus Transceivers and Registers with 3-State Outputs			✓	✓	✓	SCCS032
CY74FCT652CT	24	Octal Bus Transceivers and Registers with 3-State Outputs			✓	✓	✓	SCCS032
CY74FCT652T	24	Octal Bus Transceivers and Registers with 3-State Outputs			✓		✓	SCCS032
CY29FCT818AT	24	Diagnostic Scan Registers	✓					SCCS012
CY29FCT818CT	24	Diagnostic Scan Registers		✓	✓	✓	✓	SCCS012
CY74FCT821AT	24	10-Bit Bus-Interface Flip-Flops with 3-State Outputs			✓	✓	✓	SCCS033
CY74FCT821BT	24	10-Bit Bus-Interface Flip-Flops with 3-State Outputs		✓		✓		SCCS033
CY74FCT821CT	24	10-Bit Bus-Interface Flip-Flops with 3-State Outputs			✓	✓	✓	SCCS033
CY74FCT823AT	24	9-Bit Bus-Interface Flip-Flops with 3-State Outputs		✓	✓	✓	✓	SCCS033
CY74FCT823BT	24	9-Bit Bus-Interface Flip-Flops with 3-State Outputs		✓				SCCS033
CY74FCT823CT	24	9-Bit Bus-Interface Flip-Flops with 3-State Outputs			✓	✓	✓	SCCS033
CY74FCT825CT	24	8-Bit Bus-Interface Flip-Flops with 3-State Outputs			✓		✓	SCCS033
CY74FCT827AT	24	10-Bit Buffers/Drivers with 3-State Outputs			✓	✓	✓	SCCS034
CY74FCT827CT	24	10-Bit Buffers/Drivers with 3-State Outputs			✓	✓	✓	SCCS034

# DEVICE SELECTION GUIDE

## FCT

DEVICE	NO. PINS	DESCRIPTION	AVAILABILITY				LITERATURE REFERENCE	
			MIL	PDIP	QSOP	SOIC		SSOP
CY74FCT841AT	24	10-Bit Bus-Interface D-Type Latches with 3-State Outputs	✓			✓		SCCS035
CY74FCT841BT	24	10-Bit Bus-Interface D-Type Latches with 3-State Outputs		✓				SCCS035
CY74FCT841CT	24	10-Bit Bus-Interface D-Type Latches with 3-State Outputs			✓	✓	✓	SCCS035
CD74FCT843A	24	9-Bit Bus-Interface D-Type Latches with 3-State Outputs				✓		SCHS267
CY74FCT2240AT	20	Octal Buffers/Line Drivers with Series Damping Resistors and 3-State Outputs			✓		✓	SCCS036
CY74FCT2240CT	20	Octal Buffers/Line Drivers with Series Damping Resistors and 3-State Outputs			✓	✓	✓	SCCS036
CY74FCT2240T	20	Octal Buffers/Line Drivers with Series Damping Resistors and 3-State Outputs				✓		SCCS036
CY74FCT2244AT	20	Octal Buffers/Line Drivers with Series Damping Resistors and 3-State Outputs			✓	✓	✓	SCCS036
CY74FCT2244CT	20	Octal Buffers/Line Drivers with Series Damping Resistors and 3-State Outputs			✓	✓	✓	SCCS036
CY74FCT2244T	20	Octal Buffers/Line Drivers with Series Damping Resistors and 3-State Outputs			✓	✓	✓	SCCS036
CY74FCT2245AT	20	Octal Bus Transceivers with Series Damping Resistors and 3-State Outputs		✓	✓	✓	✓	SCCS037
CY74FCT2245CT	20	Octal Bus Transceivers with Series Damping Resistors and 3-State Outputs			✓	✓	✓	SCCS037
CY74FCT2245T	20	Octal Bus Transceivers with Series Damping Resistors and 3-State Outputs			✓	✓	✓	SCCS037
CY74FCT2257AT	16	Quad 1-of-2 Data Selectors/Multiplexers with Series Damping Resistors and 3-State Outputs			✓		✓	SCCS038
CY74FCT2257CT	16	Quad 1-of-2 Data Selectors/Multiplexers with Series Damping Resistors and 3-State Outputs			✓	✓	✓	SCCS038
CY74FCT2373AT	20	Octal Transparent D-Type Latches with Series Damping Resistors and 3-State Outputs			✓		✓	SCCS039
CY74FCT2373CT	20	Octal Transparent D-Type Latches with Series Damping Resistors and 3-State Outputs			✓	✓	✓	SCCS039
CY74FCT2373T	20	Octal Transparent D-Type Latches with Series Damping Resistors and 3-State Outputs			✓		✓	SCCS039
CY74FCT2374AT	20	Octal Transparent D-Type Latches with Series Damping Resistors and 3-State Outputs			✓	✓	✓	SCCS040
CY74FCT2374CT	20	Octal Transparent D-Type Latches with Series Damping Resistors and 3-State Outputs			✓	✓	✓	SCCS040
CY74FCT2374T	20	Octal Transparent D-Type Latches with Series Damping Resistors and 3-State Outputs				✓		SCCS040
CY74FCT2541AT	20	Octal Line Drivers/MOS Drivers with 3-State Outputs			✓	✓	✓	SCCS041
CY74FCT2541CT	20	Octal Line Drivers/MOS Drivers with 3-State Outputs			✓	✓	✓	SCCS041
CY74FCT2541T	20	Octal Line Drivers/MOS Drivers with 3-State Outputs			✓	✓	✓	SCCS041
CY74FCT2543AT	24	Octal Registered Transceivers with Series Damping Resistors and 3-State Outputs			✓	✓	✓	SCCS042
CY74FCT2543CT	24	Octal Registered Transceivers with Series Damping Resistors and 3-State Outputs			✓	✓	✓	SCCS042
CY74FCT2543T	24	Octal Registered Transceivers with Series Damping Resistors and 3-State Outputs			✓		✓	SCCS042
CY74FCT2573AT	20	Octal Transparent D-Type Latches with Series Damping Resistors and 3-State Outputs			✓		✓	SCCS039

DEVICE	NO. PINS	DESCRIPTION	AVAILABILITY					LITERATURE REFERENCE	
			MIL	PDIP	QSOP	SOIC	SSOP		TSSOP
CY74FCT2573CT	20	Octal Transparent D-Type Latches with Series Damping Resistors and 3-State Outputs			✓	✓	✓	SCCS039	
CY74FCT2573T	20	Octal Transparent D-Type Latches with Series Damping Resistors and 3-State Outputs				✓		SCCS039	
CY74FCT2574AT	20	Octal Transparent D-Type Latches with Series Damping Resistors and 3-State Outputs			✓	✓	✓	SCCS040	
CY74FCT2574CT	20	Octal Transparent D-Type Latches with Series Damping Resistors and 3-State Outputs			✓	✓	✓	SCCS040	
CY74FCT2574T	20	Octal Transparent D-Type Latches with Series Damping Resistors and 3-State Outputs				✓		SCCS040	
CY74FCT2646AT	24	Octal Registered Bus Transceivers with Series Damping Resistors and 3-State Outputs			✓		✓	SCCS043	
CY74FCT2646CT	24	Octal Registered Bus Transceivers with Series Damping Resistors and 3-State Outputs			✓		✓	SCCS043	
CY74FCT2652AT	24	Octal Bus Transceivers and Registers with Series Damping Resistors and 3-State Outputs			✓		✓	SCCS044	
CY74FCT2652CT	24	Octal Bus Transceivers and Registers with Series Damping Resistors and 3-State Outputs			✓		✓	SCCS044	
CY74FCT2827AT	24	10-Bit Buffers/Drivers with Series Damping Resistors and 3-State Outputs			✓		✓	SCCS045	
CY74FCT2827CT	24	10-Bit Buffers/Drivers with Series Damping Resistors and 3-State Outputs			✓		✓	SCCS045	
CD74FCT2952A	24	Octal Bus Transceivers and Registers with 3-State Outputs				✓		SCBS720	
CY74FCT16240AT	48	16-Bit Buffers/Drivers with 3-State Outputs					✓	SCCS027	
CY74FCT16244AT	48	16-Bit Buffers/Drivers with 3-State Outputs					✓	✓	SCCS028
CY74FCT16244CT	48	16-Bit Buffers/Drivers with 3-State Outputs					✓	✓	SCCS028
CY74FCT16244T	48	16-Bit Buffers/Drivers with 3-State Outputs					✓	✓	SCCS028
CY74FCT16245AT	48	16-Bit Bus Transceivers with 3-State Outputs					✓	✓	SCCS026
CY74FCT16245CT	48	16-Bit Bus Transceivers with 3-State Outputs					✓	✓	SCCS026
CY74FCT16245T	48	16-Bit Bus Transceivers with 3-State Outputs					✓	✓	SCCS026
CY74FCT16373AT	48	16-Bit Transparent D-Type Latches with 3-State Outputs					✓	✓	SCCS054
CY74FCT16373CT	48	16-Bit Transparent D-Type Latches with 3-State Outputs					✓	✓	SCCS054
CY74FCT16374AT	48	16-Bit Edge-Triggered D-Type Flip-Flops with 3-State Outputs					✓	✓	SCCS055
CY74FCT16374CT	48	16-Bit Edge-Triggered D-Type Flip-Flops with 3-State Outputs					✓	✓	SCCS055
CY74FCT16374T	48	16-Bit Edge-Triggered D-Type Flip-Flops with 3-State Outputs					✓		SCCS055
CY74FCT16500CT	56	18-Bit Universal Bus Transceivers with 3-State Outputs					✓	✓	SCCS056
CY74FCT16501AT	56	18-Bit Universal Bus Transceivers with 3-State Outputs					✓		SCCS057
CY74FCT16543AT	56	16-Bit Registered Transceivers with 3-State Outputs						✓	SCCS059
CY74FCT16543CT	56	16-Bit Registered Transceivers with 3-State Outputs					✓		SCCS059
CY74FCT16543T	56	16-Bit Registered Transceivers with 3-State Outputs					✓		SCCS059
CY74FCT16646AT	56	16-Bit Bus Transceivers and Registers with 3-State Outputs					✓		SCCS060
CY74FCT16646CT	56	16-Bit Bus Transceivers and Registers with 3-State Outputs					✓		SCCS060
CY74FCT16646T	56	16-Bit Bus Transceivers and Registers with 3-State Outputs					✓		SCCS060
CY74FCT16652AT	56	16-Bit Bus Transceivers and Registers with 3-State Outputs					✓		SCCS061
CY74FCT16652CT	56	16-Bit Bus Transceivers and Registers with 3-State Outputs					✓		SCCS061
CY74FCT16823AT	56	18-Bit D-Type Flip-Flops with 3-State Outputs						✓	SCCS062
CY74FCT16823CT	56	18-Bit D-Type Flip-Flops with 3-State Outputs					✓	✓	SCCS062

# DEVICE SELECTION GUIDE

## FCT

DEVICE	NO. PINS	DESCRIPTION	AVAILABILITY					LITERATURE REFERENCE	
			MIL	PDIP	QSOP	SOIC	SSOP		TSSOP
CY74FCT16827AT	56	20-Bit Buffers/Drivers with 3-State Outputs					✓		SCCS064
CY74FCT16827CT	56	20-Bit Buffers/Drivers with 3-State Outputs					✓	✓	SCCS064
CY74FCT16841AT	56	20-Bit Bus-Interface D-Type Latches with 3-State Outputs					✓		SCCS067
CY74FCT16841CT	56	20-Bit Bus-Interface D-Type Latches with 3-State Outputs					✓		SCCS067
CY74FCT16952AT	56	16-Bit Registered Transceivers with 3-State Outputs					✓		SCCS065
CY74FCT16952CT	56	16-Bit Registered Transceivers with 3-State Outputs						✓	SCCS065
CY74FCT162240CT	48	16-Bit Buffers/Drivers with 3-State Outputs					✓	✓	SCCS027
CY74FCT162244AT	48	16-Bit Buffers/Drivers with 3-State Outputs					✓	✓	SCCS028
CY74FCT162244CT	48	16-Bit Buffers/Drivers with 3-State Outputs					✓	✓	SCCS028
CY74FCT162244T	48	16-Bit Buffers/Drivers with 3-State Outputs					✓	✓	SCCS028
CY74FCT162H244AT	48	16-Bit Buffers/Drivers with Bus Hold and 3-State Outputs						✓	SCCS028
CY74FCT162H244CT	48	16-Bit Buffers/Drivers with Bus Hold and 3-State Outputs					✓		SCCS028
CY74FCT162245AT	48	16-Bit Bus Transceivers with 3-State Outputs					✓	✓	SCCS026
CY74FCT162245CT	48	16-Bit Bus Transceivers with 3-State Outputs					✓	✓	SCCS026
CY74FCT162245T	48	16-Bit Bus Transceivers with 3-State Outputs					✓	✓	SCCS026
CY74FCT162H245AT	48	16-Bit Bus Transceivers with Bus Hold and 3-State Outputs					✓	✓	SCCS026
CY74FCT162H245CT	48	16-Bit Bus Transceivers with Bus Hold and 3-State Outputs					✓	✓	SCCS026
CY74FCT162373AT	48	16-Bit Transparent D-Type Latches with 3-State Outputs					✓	✓	SCCS054
CY74FCT162373CT	48	16-Bit Transparent D-Type Latches with 3-State Outputs					✓	✓	SCCS054
CY74FCT162374AT	48	16-Bit Edge-Triggered D-Type Flip-Flops with 3-State Outputs					✓	✓	SCCS055
CY74FCT162374CT	48	16-Bit Edge-Triggered D-Type Flip-Flops with 3-State Outputs					✓	✓	SCCS055
CY74FCT162374T	48	16-Bit Edge-Triggered D-Type Flip-Flops with 3-State Outputs					✓		SCCS055
CY74FCT162500AT	56	18-Bit Universal Bus Transceivers with 3-State Outputs					✓		SCCS056
CY74FCT162500CT	56	18-Bit Universal Bus Transceivers with 3-State Outputs					✓		SCCS056
CY74FCT162501AT	56	18-Bit Universal Bus Transceivers with 3-State Outputs					✓	✓	SCCS057
CY74FCT162501CT	56	18-Bit Universal Bus Transceivers with 3-State Outputs					✓	✓	SCCS057
CY74FCT162H501CT	56	18-Bit Universal Bus Transceivers with Bus Hold and 3-State Outputs					✓	✓	SCCS057
CY74FCT162543AT	56	16-Bit Registered Transceivers with 3-State Outputs						✓	SCCS059
CY74FCT162543CT	56	16-Bit Registered Transceivers with 3-State Outputs					✓	✓	SCCS059
CY74FCT162543T	56	16-Bit Registered Transceivers with 3-State Outputs					✓		SCCS059
CY74FCT162H543CT	56	16-Bit Registered Transceivers with Bus Hold and 3-State Outputs						✓	SCCS059
CY74FCT162646AT	56	16-Bit Bus Transceivers and Registers with 3-State Outputs					✓	✓	SCCS060
CY74FCT162646CT	56	16-Bit Bus Transceivers and Registers with 3-State Outputs					✓	✓	SCCS060
CY74FCT162652AT	56	16-Bit Bus Transceivers and Registers with 3-State Outputs					✓		SCCS061
CY74FCT162652CT	56	16-Bit Bus Transceivers and Registers with 3-State Outputs					✓	✓	SCCS061
CY74FCT162823AT	56	18-Bit D-Type Flip-Flops with 3-State Outputs						✓	SCCS062
CY74FCT162823CT	56	18-Bit D-Type Flip-Flops with 3-State Outputs					✓	✓	SCCS062
CY74FCT162827AT	56	20-Bit Buffers/Drivers with 3-State Outputs					✓		SCCS064
CY74FCT162827BT	56	20-Bit Buffers/Drivers with 3-State Outputs					✓		SCCS064
CY74FCT162827CT	56	20-Bit Buffers/Drivers with 3-State Outputs						✓	SCCS064
CY74FCT162841CT	56	20-Bit Bus-Interface D-Type Latches with 3-State Outputs					✓	✓	SCCS067
CY74FCT162952AT	56	16-Bit Registered Transceivers with 3-State Outputs						✓	SCCS065
CY74FCT162952BT	56	16-Bit Registered Transceivers with 3-State Outputs					✓		SCCS065
CY74FCT162H952AT	56	16-Bit Registered Transceivers with Bus Hold and 3-State Outputs						✓	SCCS065
CY74FCT162H952CT	56	16-Bit Registered Transceivers with Bus Hold and 3-State Outputs					✓		SCCS065



# **FIFO**

## **First-In, First-Out Memories**

Today's competitive environment creates a constant need for greater system performance. One common method to optimize system performance involves the use of a first-in, first-out (FIFO) memory to eliminate the data bottlenecks common between digital signal processors (DSPs), high-speed processors, industry-standard buses, memory devices, and analog front ends (AFEs). TI offers a wide range of FIFO devices designed for use in a variety of systems, including real-time DSP applications, telecommunications, internetworking, medical/industrial imaging, precision instrumentation, and high-bandwidth computing.

### **New DSP-Sync FIFO Products**

Designed to work directly with TI DSPs that drive today's digital revolution, TI's new DSP-sync FIFOs provide a glueless DSP interface and offer the features necessary to enhance your DSP-based system designs. These new DSP-sync FIFOs leverage TI's most advanced processing technology to create world-class FIFO performance and set new levels in cost efficiency.

Visit the TI FIFO home page at <http://www.ti.com/sc/fifo> for a comprehensive overview of TI's FIFO product line, new product releases, data sheets, application reports, and pricing.

# DEVICE SELECTION GUIDE

## FIFO

DEVICE	NO. PINS	CLOCK (MHz)	DESCRIPTION	AVAILABILITY								LITERATURE REFERENCE
				MIL	PDIP	SOIC	SSOP	PLCC	QFP	LQFP	TQFP	
<b>36-Bit Synchronous FIFOs</b>												
SN74ABT3611	132, 120	67	64 × 36, 5-V Synchronous FIFOs						✓	✓	SCBS127	
SN74ABT3613	132, 120	67	64 × 36, 5-V Synchronous FIFO						✓	✓	SCBS128	
SN74ABT3612	132, 120	67	64 × 36 × 2, 5-V Synchronous Bidirectional FIFOs						✓	✓	SCBS129	
SN74ABT3614	132, 120	67	64 × 36 × 2, 5-V Synchronous Bidirectional FIFOs	✓					✓	✓	SCBS126	
SN74ACT3622	132, 120	67	256 × 36 × 2, 5-V Synchronous Bidirectional FIFOs						✓	✓	SCAS247	
SN74ACT3631	132, 120	67	512 × 36, 5-V Synchronous FIFOs						✓	✓	SCAS246	
SN74ACT3632	132, 120	67	512 × 36 × 2, 5-V Synchronous Bidirectional FIFOs	✓					✓	✓	SCAS224	
SN74ACT3641	132, 120	67	1K × 36, 5-V Synchronous FIFOs	✓					✓	✓	SCAS338	
SN74ACT3651	132, 120	67	2K × 36, 5-V Synchronous FIFOs						✓	✓	SCAS439	
SN74ALVC3631	132, 120	100	512 × 36, 3.3-V Synchronous FIFOs						✓	✓	SDMS025	
SN74ALVC3641	132, 120	100	1K × 36, 3.3-V Synchronous FIFOs						✓	✓	SDMS025	
SN74ALVC3651	132, 120	100	2K × 36, 3.3-V Synchronous FIFOs						✓	✓	SDMS025	
SN74V3640	128	166	1024 × 36, 3.3-V Synchronous FIFOs							✓	SCAS668	
SN74V3650	128	166	2048 × 36, 3.3-V Synchronous FIFOs							✓	SCAS668	
SN74V3660	128	166	4096 × 36, 3.3-V Synchronous FIFOs							✓	SCAS668	
SN74V3670	128	166	8192 × 36, 3.3-V Synchronous FIFOs							✓	SCAS668	
SN74V3680	128	166	16384 × 36, 3.3-V Synchronous FIFOs							✓	SCAS668	
SN74V3690	128	166	32768 × 36, 3.3-V Synchronous FIFOs							✓	SCAS668	
<b>32-Bit Synchronous FIFOs</b>												
SN74ACT3638	132, 120	67	512 × 32 × 2, 5-V Synchronous Bidirectional FIFOs						✓	✓	SCAS228	

### commercial package description and availability

#### DSBGA (die-size ball grid array)†

YEA, YZA = 5/6/8 pins  
YEP, YZP = 5/6/8 pins

#### LFBGA (low-profile fine-pitch ball grid array)

GGM = 80/100 pins  
GKE, ZKE = 96 pins  
GKF, ZKF = 114 pins

#### VFBGA (very-thin-profile fine-pitch ball grid array)

GQN, ZQN = 20 pins  
GQL, ZQL = 56 pins (also includes 48-pin functions)

#### schedule

✓ = Now    ✚ = Planned

#### PDIP (plastic dual-in-line package)

P = 8 pins  
N = 14/16/20/24 pins  
NT = 24/28 pins

#### PLCC (plastic leaded chip carrier)

FN = 20/28/44/68/84 pins

#### SOIC (small-outline integrated circuit)

D = 8/14/16 pins  
DW = 16/18/20/24/28 pins

#### SOT (small-outline transistor)

PK = 3 pins  
DBV = 3/4/5 pins  
DCY = 4 pins  
DCK = 5/6 pins

#### QFN (quad flatpack no lead)

RGY = 14/16/20 pins  
RGQ = 56 pins

#### QFP (quad flatpack)

RC = 52 pins (FB only)  
PH = 80 pins (FIFOs only)  
PQ = 100/132 pins (FIFOs only)

#### LQFP (low-profile quad flatpack)

PZA = 80 pins

#### TQFP (plastic thin quad flatpack)

PAH = 52 pins  
PAG = 64 pins (FB only)  
PM = 64 pins  
PN = 80 pins  
PCA, PZ = 100 pins (FB only)  
PCB = 120 pins (FIFOs only)

#### SOP (small-outline package)

PS = 8 pins  
NS = 14/16/20/24 pins

#### QSOP (quarter-size small-outline package)

DBQ = 16/20/24 pins

#### SSOP (shrink small-outline package)

DCT = 8 pins  
DB = 14/16/20/24/28/30/38 pins  
DBQ = 16/20/24 pins  
DL = 28/48/56 pins

#### TSSOP (thin shrink small-outline package)

PW = 8/14/16/20/24/28 pins  
DGG = 48/56/64 pins

#### TVSOP (thin very small-outline package)

DGV = 14/16/20/24/48/56 pins  
DBB = 80/100 pins

#### VSSOP (very thin shrink small-outline package)

DCU = 8 pins

† JEDEC reference for wafer chip scale package (WCSP)

DEVICE	NO. PINS	CLOCK (MHz)	DESCRIPTION	AVAILABILITY							LITERATURE REFERENCE		
				MIL	PDIP	SOIC	SSOP	PLCC	QFP	LQFP		TQFP	LFPGA
<b>18-Bit Synchronous FIFOs</b>													
SN74ACT7813	56	67	64 × 18, 5-V Synchronous FIFOs				✓					SCAS199	
SN74ACT7805	56	67	256 × 18, 5-V Synchronous FIFOs				✓					SCAS201	
SN74ACT7803	56	67	512 × 18, 5-V Synchronous FIFOs				✓					SCAS191	
SN74ABT7819	80	100	512 × 18 × 2, 5-V Synchronous Bidirectional FIFOs	✓					✓		✓	SCBS125	
SN74ACT7811	68, 80	67	1K × 18, 5-V Synchronous FIFOs	✓				✓			✓	SCAS151	
SN74ACT7881	68, 80	67	1K × 18, 5-V Synchronous FIFOs	✓				✓			✓	SCAS227	
SN74ACT7882	68, 80	67	2K × 18, 5-V Synchronous FIFOs					✓			✓	SCAS445	
SN74ALVC7813	56	50	64 × 18, 3.3-V Synchronous FIFOs				✓					SCAS594	
SN74ALVC7805	56	50	256 × 18, 3.3-V Synchronous FIFOs				✓					SCAS593	
SN74ALVC7803	56	50	512 × 18, 3.3-V Synchronous FIFOs				✓					SCAS436	
SN74V215	64	133	512 × 18, 3.3-V Synchronous FIFOs								✓	SCAS636	
SN74V225	64	133	1K × 18, 3.3-V Synchronous FIFOs								✓	SCAS636	
SN74V235	64	133	2K × 18, 3.3-V Synchronous FIFOs								✓	SCAS636	
SN74V245	64	133	4K × 18, 3.3-V Synchronous FIFOs								✓	SCAS636	
SN74V263	80, 100	166	8K × 18/16K × 9, 3.3-V Synchronous FIFOs							✓		+	SCAS669
SN74V273	80, 100	166	16K × 18/32K × 9, 3.3-V Synchronous FIFOs							✓		+	SCAS669
SN74V283	80, 100	166	32K × 18/64K × 9, 3.3-V Synchronous FIFOs							✓		+	SCAS669
SN74V293	80, 100	166	64K × 18/128K × 9, 3.3-V Synchronous FIFOs							✓		+	SCAS669
<b>18-Bit Asynchronous FIFOs</b>													
SN74ACT7814	56	50	64 × 18, 5-V Asynchronous FIFOs				✓					SCAS209	
SN74ACT7806	56	50	256 × 18, 5V Asynchronous FIFOs0				✓					SCAS438	
SN74ACT7804	56	50	512 × 18, 5-V Asynchronous FIFOs				✓					SCAS204	
SN74ABT7820	80	67	512 × 18 × 2, 5-V Asynchronous Bidirectional FIFOs	✓					✓		✓	SCAS206	
SN74ACT7802	80	40	1K × 18, 5-V Asynchronous FIFOs					✓			✓	SCAS187	
SN74ALVC7814	56	40	64 × 18, 3.3-V Asynchronous FIFOs				✓					SCAS592	
SN74ALVC7806	56	40	256 × 18, 3.3-V Asynchronous FIFOs				✓					SCAS591	
SN74ALVC7804	56	40	512 × 18, 3.3-V Asynchronous FIFOs				✓					SCAS437	
<b>9-Bit FIFOs</b>													
SN74ACT2235	44, 64	50	1K × 9 × 2, 5-V Asynchronous Bidirectional FIFOs					✓			✓	SCAS148	
SN74ACT7807	44, 64	67	2K × 9, 5-V Synchronous FIFOs					✓			✓	SCAS200	
SN74ACT7808	44, 64	50	2K × 9, 5-V Asynchronous FIFOs					✓			✓	SCAS205	

# DEVICE SELECTION GUIDE

## FIFO

DEVICE	NO. PINS	CLOCK (MHz)	DESCRIPTION	AVAILABILITY							LITERATURE REFERENCE
				MIL	PDIP	SOIC	SSOP	PLCC	QFP	LQFP	
<b>1-Bit Telecommunication FIFOs</b>											
SN74ACT2226	24	22	64 × 1 × 2, 5-V Independent Synchronous FIFOs			✓					SCAS219
SN74ACT2227	28	60	64 × 1 × 2, 5-V Independent Synchronous FIFOs			✓					SCAS220
SN74ACT2228	24	22	256 × 1 × 2, 5-V Independent Synchronous FIFOs			✓					SCAS219
SN74ACT2229	28	60	256 × 1 × 2, 5-V Independent Synchronous FIFOs			✓					SCAS220
<b>Mature Products</b>											
SN74LS224A	16	10	16 × 4, 5-V Synchronous FIFOs	✓	✓						SDLS023
SN74ALS232B	16, 20	40	16 × 4, 5-V Asynchronous FIFOs		✓	✓		✓			SCAS251
SN74ALS236	16	30	16 × 4, 5-V Asynchronous FIFOs		✓						SDAS107
CD40105B	16	3	16 × 4, 5-V Asynchronous FIFOs	✓	✓						SCHS096
CD74HC40105	16	12	16 × 4, 5-V Asynchronous FIFOs	✓	✓	✓					SCHS222
CD74HCT40105	16	12	16 × 4, 5-V Asynchronous FIFOs	✓	✓	✓					SCHS222
SN74S225	20	10	16 × 5, 5-V Asynchronous FIFOs		✓						SDLS207
SN74ALS229B	20	40	16 × 5, 5-V Asynchronous FIFOs		✓	✓					SDAS090
SN74ALS233B	20	40	16 × 5, 5-V Asynchronous FIFOs		✓	✓		✓			SCAS253

## GTL

### Gunning Transceiver Logic

GTL devices are high-speed transceivers operating at LVTTTL logic levels on the A port and at GTL/GTL+ signal levels on the B port. The devices are designed with faster edge rates for point-to-point applications in which hot insertion is not a requirement. The devices operate at the JEDEC JESD8-3 GTL or at the higher threshold-voltage/lower noise-margin GTL+ signal levels. Use GTLP devices in applications that require a slower edge rate for optimal signal-integrity performance.

GTL family features:

- 3.3-V or 3.3-/5-V  $V_{CC}$  operation with 5-V-tolerant LVTTTL I/Os (except 'GTL1655) permits the devices to act as 5-V CMOS/TTL or 3.3-V LVTTTL-to-GTL+/GTL and GTL+/GTL-to-3.3-V LVTTTL translators.
- OEC™ circuitry reduces line reflections, electromagnetic interference (EMI), and improves overall signal integrity.
- B-port drive of 50 mA and 100 mA ('GTL1655 only) allows the designer flexibility in matching the device to the application.
- $I_{off}$  circuitry prevents damage during partial-power-down situations.
- Power-up 3-state (PU3S) and BIAS  $V_{CC}$  circuitry ('GTL1655 only) permit true live-insertion capability.
- Bus-hold circuitry (A port only) eliminates floating inputs by holding them at the last valid logic state. No external pullup or pulldown resistors are needed for unused or undriven inputs, which reduces power, cost, and board layout time.

See <http://www.ti.com/sc/gtl> for further information. TI provides a wide range of design assistance, including application support, application reports, free samples, demonstration backplane, and HSPICE/IBIS simulation models.

# DEVICE SELECTION GUIDE

## GTL

DEVICE	NO. PINS	DESCRIPTION	AVAILABILITY			LITERATURE REFERENCE
			MIL	SSOP	TSSOP	
SN74GTL1655	64	16-Bit LVTTTL-to-GTL/GTL+ Universal Bus Transceivers with Live Insertion			✓	SCBS696
SN74GTL16612	56	18-Bit LVTTTL-to-GTL/GTL+ Universal Bus Transceivers	✓	✓	✓	SCBS480
SN74GTL16616	56	17-Bit LVTTTL-to-GTL/GTL+ Universal Bus Transceivers with Buffered Clock Outputs		✓	✓	SCBS481
SN74GTL16622A	64	18-Bit LVTTTL-to-GTL/GTL+ Registered Bus Transceivers			✓	SCBS673
SN74GTL16923	64	18-Bit LVTTTL-to-GTL/GTL+ Registered Bus Transceivers			✓	SCBS674

### commercial package description and availability

#### DSBGA (die-size ball grid array)†

YEA, YZA = 5/6/8 pins  
YEP, YZP = 5/6/8 pins

#### LFBGA (low-profile fine-pitch ball grid array)

GGM = 80/100 pins  
GKE, ZKE = 96 pins  
GKF, ZKF = 114 pins

#### VFPGA (very-thin-profile fine-pitch ball grid array)

GQN, ZQN = 20 pins  
GQL, ZQL = 56 pins (also includes 48-pin functions)

#### schedule

✓ = Now   ✚ = Planned

#### PDIP (plastic dual-in-line package)

P = 8 pins  
N = 14/16/20/24 pins  
NT = 24/28 pins

#### PLCC (plastic leaded chip carrier)

FN = 20/28/44/68/84 pins

#### SOIC (small-outline integrated circuit)

D = 8/14/16 pins  
DW = 16/18/20/24/28 pins

#### SOT (small-outline transistor)

PK = 3 pins  
DBV = 3/4/5 pins  
DCY = 4 pins  
DCK = 5/6 pins

#### QFN (quad flatpack no lead)

RGY = 14/16/20 pins  
RGQ = 56 pins

#### QFP (quad flatpack)

RC = 52 pins (FB only)  
PH = 80 pins (FIFOs only)  
PQ = 100/132 pins (FIFOs only)

#### LQFP (low-profile quad flatpack)

PZA = 80 pins

#### TQFP (plastic thin quad flatpack)

PAH = 52 pins  
PAG = 64 pins (FB only)  
PM = 64 pins  
PN = 80 pins  
PCA, PZ = 100 pins (FB only)  
PCB = 120 pins (FIFOs only)

#### SOP (small-outline package)

PS = 8 pins  
NS = 14/16/20/24 pins

#### QSOP (quarter-size small-outline package)

DBQ = 16/20/24 pins

#### SSOP (shrink small-outline package)

DCT = 8 pins  
DB = 14/16/20/24/28/30/38 pins  
DBQ = 16/20/24 pins  
DL = 28/48/56 pins

#### TSSOP (thin shrink small-outline package)

PW = 8/14/16/20/24/28 pins  
DGG = 48/56/64 pins

#### TVSOP (thin very small-outline package)

DGV = 14/16/20/24/48/56 pins  
DBB = 80/100 pins

#### VSSOP (very thin shrink small-outline package)

DCU = 8 pins

† JEDEC reference for wafer chip scale package (WCSP)



# GTLP

## Gunning Transceiver Logic Plus

GTLP devices are high-speed CMOS transceivers specifically designed for heavily loaded parallel backplane applications. The reduced output swing (<1 V), reduced input threshold levels, differential input, and OEC™ and TI-OPC™ circuitry on the GTLP rising and falling edges reduces EMI and improves overall signal integrity, allowing higher backplane clock frequencies. This increases the bandwidth for manufacturers developing improved data-communication solutions.

GTLP solves high-performance parallel backplane designers' needs:

- Offers higher backplane data rates (100+ Mbps) for increased data-throughput requirements, lower EMI, and lower power consumption
- $I_{off}$ , power-up 3-state (PU3S), and BIAS  $V_{CC}$  circuitry support true live-insertion capability for easy internal precharging of the backplane I/O pins for applications in which active backplane data cannot be suspended or disturbed during card insertion or removal.

GTLP family features:

- 3.3-V  $V_{CC}$  with 5-V-tolerant LVTTTL I/Os permits GTLP devices to act as 5-V CMOS, TTL, or LVTTTL-to-GTLP and GTLP-to-LVTTTL or TTL translators.
- A-port (LVTTTL side) balanced drive of  $\pm 24$  mA
- B-port (GTLP side) open drain sinks either 50 mA or 100 mA of current, allowing the designer flexibility in matching the best device to the backplane characteristics, which are dependent on the length, slot spacing, and distributed capacitance (among other factors).
- Edge-rate control (ERC) circuitry allows either fast or slow edge rates.
- One-third the static power consumption of BiCMOS logic devices
- A-port bus-hold circuitry (GTLPH only) eliminates floating inputs by holding them at the last valid logic state.

See <http://www.ti.com/sc/gtlp> for further information. TI provides a wide range of design assistance, including application reports and support, free samples, demonstration backplane, and HSPICE/IBIS simulation models.

### Migration Path From GTLPH16912

MEDIUM-DRIVE UNIVERSAL BUS TRANSCEIVER  
 '16601 Pinout – 18 Bits With OE, LE, CLK, and CE Controls

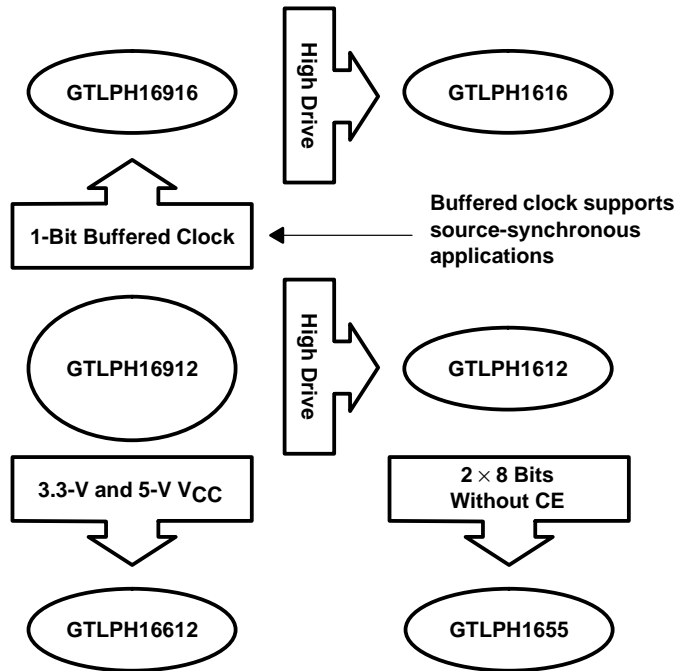

### Migration Path From GTLPH16945

MEDIUM-DRIVE BUS TRANSCEIVER  
 '16245 Pinout – 2 × 8 Bits With Separate DIR and OE Controls

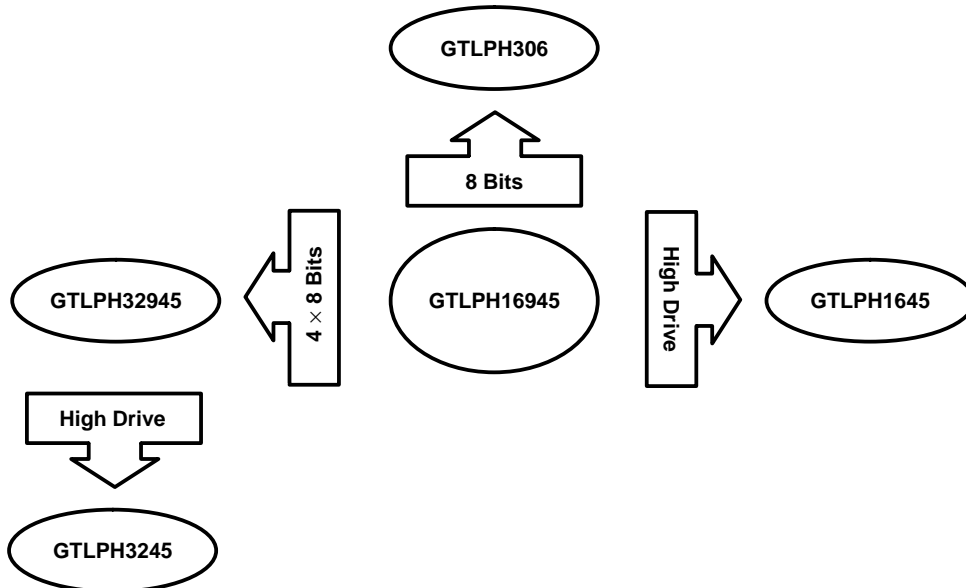



DEVICE	NO. PINS	DESCRIPTION	AVAILABILITY						LITERATURE REFERENCE	
			LFBGA	QFN	SOIC	SSOP	TSSOP	TVSOP		VFBGA
SN74GTLPH306	24	8-Bit LVTTTL-to-GTLP Bus Transceivers			✓		✓	✓	SCES284	
SN74GTLPH817	24	GTLP-to-LVTTTL 1-to-6 Fanout Drivers			✓		✓	✓	SCES285	
SN74GTLPH1394	16	2-Bit LVTTTL-to-GTLP Adjustable-Edge-Rate Bus Transceivers with Selectable Polarity		✓	✓		✓	✓	SCES286	
SN74GTLPH1395	20	Dual 1-Bit LVTTTL-to-GTLP Adjustable-Edge-Rate Bus Transceivers with Split LVTTTL Port, Feedback Path, and Selectable Polarity			✓		✓	✓	✓	SCES349
SN74GTLPH1612	64	18-Bit LVTTTL-to-GTLP Adjustable-Edge-Rate Universal Bus Transceivers					✓		SCES287	
SN74GTLPH1616	64	17-Bit LVTTTL-to-GTLP Adjustable-Edge-Rate Universal Bus Transceivers with Buffered Clock Outputs					✓		SCES346	
SN74GTLPH1645	56	16-Bit LVTTTL-to-GTLP Adjustable-Edge-Rate Bus Transceivers					✓	✓	✓	SCES290
SN74GTLPH1655	64	16-Bit LVTTTL-to-GTLP Adjustable-Edge-Rate Universal Bus Transceivers					✓		SCES294	
SN74GTLPH2033	48	8-Bit LVTTTL-to-GTLP Adjustable-Edge-Rate Registered Transceivers with Split LVTTTL Port and Feedback Path					✓	✓	✓	SCES352
SN74GTLPH2034	48	8-Bit LVTTTL-to-GTLP Adjustable-Edge-Rate Registered Transceivers with Split LVTTTL Port and Feedback Path					✓	✓	✓	SCES353
SN74GTLPH3245	114	32-Bit LVTTTL-to-GTLP Adjustable-Edge-Rate Bus Transceivers	✓							SCES291
SN74GTLPH16612	56	18-Bit LVTTTL to GTLP Universal Bus Transceivers				✓	✓		SCES326	
SN74GTLPH16912	56	18-Bit LVTTTL-to-GTLP Universal Bus Transceivers					✓	✓	SCES288	
SN74GTLPH16916	56	17-Bit LVTTTL-to-GTLP Universal Bus Transceivers with Buffered Clock Outputs					✓	✓	SCES347	
SN74GTLPH16927	56	18-Bit LVTTTL-to-GTLP Bus Transceivers with Source-Synchronous Clock Outputs					✓	✓	✓	SCES413
SN74GTLPH16945	48/56	16-Bit LVTTTL-to-GTLP Bus Transceivers					✓	✓	+	SCES292
SN74GTLPH21395	20	Dual 1-Bit LVTTTL-to-GTLP Adjustable-Edge-Rate Bus Transceivers with Split LVTTTL Port, Feedback Path, and Selectable Polarity			✓		✓	✓	✓	SCES350

**commercial package description and availability**

**DSBGA** (die-size ball grid array)†

YEA, YZA = 5/6/8 pins  
YEP, YZP = 5/6/8 pins

**LFBGA** (low-profile fine-pitch ball grid array)

GGM = 80/100 pins  
GKE, ZKE = 96 pins  
GKF, ZKF = 114 pins

**VFBGA** (very-thin-profile fine-pitch ball grid array)

GQN, ZQN = 20 pins  
GQL, ZQL = 56 pins (also includes 48-pin functions)

**schedule**

✓ = Now ✦ = Planned

**PDIP** (plastic dual-in-line package)

P = 8 pins  
N = 14/16/20/24 pins  
NT = 24/28 pins

**PLCC** (plastic leaded chip carrier)

FN = 20/28/44/68/84 pins

**SOIC** (small-outline integrated circuit)

D = 8/14/16 pins  
DW = 16/18/20/24/28 pins

**SOT** (small-outline transistor)

PK = 3 pins  
DBV = 3/4/5 pins  
DCY = 4 pins  
DCK = 5/6 pins

**QFN** (quad flatpack no lead)

RGY = 14/16/20 pins  
RGQ = 56 pins

**QFP** (quad flatpack)

RC = 52 pins (FB only)  
PH = 80 pins (FIFOs only)  
PQ = 100/132 pins (FIFOs only)

**LQFP** (low-profile quad flatpack)

PZA = 80 pins

**TQFP** (plastic thin quad flatpack)

PAH = 52 pins  
PAG = 64 pins (FB only)  
PM = 64 pins  
PN = 80 pins  
PCA, PZ = 100 pins (FB only)  
PCB = 120 pins (FIFOs only)

**SOP** (small-outline package)

PS = 8 pins  
NS = 14/16/20/24 pins

**QSOP** (quarter-size small-outline package)

DBQ = 16/20/24 pins

**SSOP** (shrink small-outline package)

DCT = 8 pins  
DB = 14/16/20/24/28/30/38 pins  
DBQ = 16/20/24 pins  
DL = 28/48/56 pins

**TSSOP** (thin shrink small-outline package)

PW = 8/14/16/20/24/28 pins  
DGG = 48/56/64 pins

**TVSOP** (thin very small-outline package)

DGV = 14/16/20/24/48/56 pins  
DBB = 80/100 pins

**VSSOP** (very thin shrink small-outline package)

DCU = 8 pins

† JEDEC reference for wafer chip scale package (WCSP)

# DEVICE SELECTION GUIDE

## GTLP

DEVICE	NO. PINS	DESCRIPTION	AVAILABILITY						LITERATURE REFERENCE	
			LFBGA	QFN	SOIC	SSOP	TSSOP	TVSOP		VFBGA
SN74GTLP22033	48/56	8-Bit LVTTTL-to-GTLP Adjustable-Edge-Rate Registered Transceivers with Split LVTTTL Port and Feedback Path					✓	✓	✓	SCES354
SN74GTLP22034	48, 56	8-Bit LVTTTL-to-GTLP Adjustable-Edge-Rate Registered Transceivers with Split LVTTTL Port and Feedback Path					✓	✓	✓	SCES355
SN74GTLP32912	96	36-Bit LVTTTL-to-GTLP Universal Bus Transceivers	✓						✓	SCES379
SN74GTLP32916	96	34-Bit LVTTTL-to-GTLP Universal Bus Transceivers with Buffered Clock Outputs	✓						✓	SCES380
SN74GTLP32945	96	32-Bit LVTTTL-to-GTLP Bus Transceivers	✓							SCES293

# SN74GTLP1394

Specifically designed for use with the Texas Instruments TSB14AA1 1394 backplane layer controller family to transmit 1394 backplane serial bus across parallel backplanes

- ◆ The 1394 backplane serial bus plays a supportive role in backplane systems, providing a means for diagnostics, system enhancement, and peripheral monitoring.
- ◆ High-performance, multi-slot, parallel-backplane-optimized GTLP edge rates easily support data transfer rates of 25 Mbps (S25), 50 Mbps (S50), and 100 Mbps (S100).
- ◆ GTLP vs LVDS solutions
  - ◆ Single-chip solution
  - ◆ Easier to implement
- ◆ GTLP vs BTL/FB+ solutions
  - ◆ Better signal integrity
  - ◆ More cost effective
  - ◆ Less power consumption

64-Bit Data Bus      32- to 64-Bit Address Bus

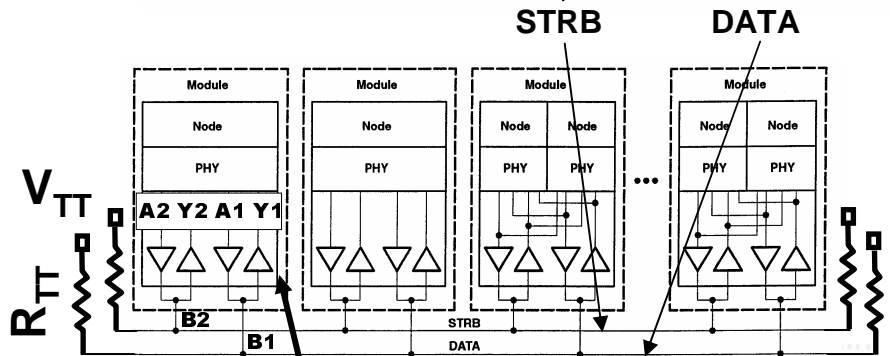
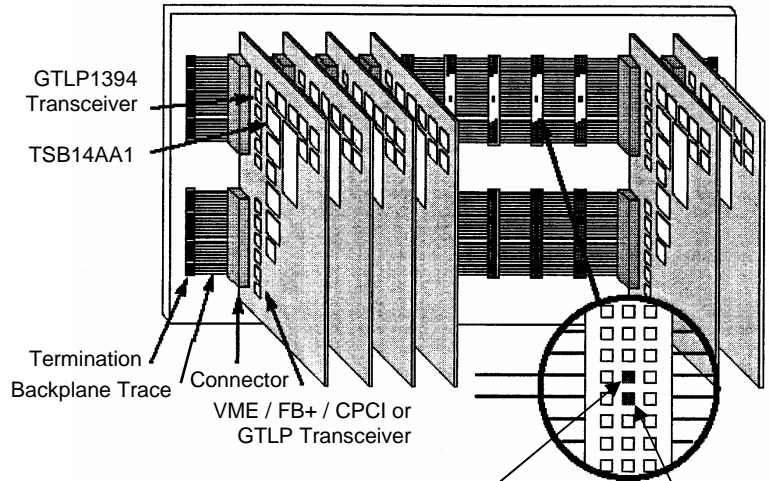

**SN74GTLP1394 main features include:**

- LVTTTL to GTLP bidirectional translator
- High GTLP drive (100 mA)
- TI-OPC™ overshoot protection circuitry
- BIAS  $V_{CC}$  supports true live insertion.
- 3.3-V  $V_{CC}$  with 5-V tolerance
- \$3.75 in lots of 1000
- 16-pin SOIC (D & DR), TSSOP (PWR), and TVSOP (DGVR) packages

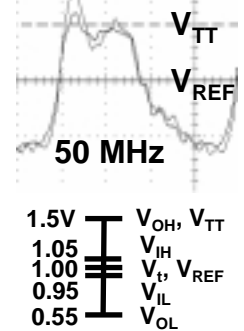
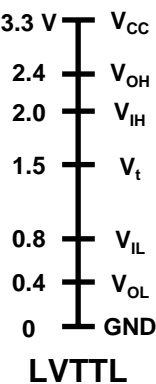

[www.ti.com/sc/1394](http://www.ti.com/sc/1394)

[www.ti.com/sc/gtlp](http://www.ti.com/sc/gtlp)

## **HC/HCT**

### **High-Speed CMOS Logic**

TI offers a full family of HC/HCT devices for low-power, medium- to low-speed applications. The recent addition of products acquired from Harris Semiconductor has added a wide range of additional functions. Over 250 HC and HCT device types are available, including gates, latches, flip-flops, buffers/drivers, counters, multiplexers, transceivers, and registered transceivers. The HC/HCT family is a popular, reliable logic family, with 6-mA output current drive at 5-V  $V_{CC}$  (HC/HCT) and 20- $\mu$ A output current drive 3.3-V  $V_{CC}$  (HC only).

While HCMOS can be used in most new designs, TI recommends Advanced High-Speed CMOS (AHC) as a reliable and effortless migration path from the HC family. AHC delivers the same low noise as HC, with one-half the static power consumption of HC, at a competitive price.

The HC family offers CMOS inputs and outputs, while the HCT family offers TTL inputs with CMOS outputs.

See [www.ti.com/sc/logic](http://www.ti.com/sc/logic) for the most current data sheets.

# DEVICE SELECTION GUIDE

## HC

DEVICE	NO. PINS	DESCRIPTION	AVAILABILITY						LITERATURE REFERENCE
			MIL	PDIP	SOIC	SOP	SSOP	TSSOP	
CD74HC00	14	Quad 2-Input NAND Gates	✓	✓	✓				SCHS116
SN74HC00	14	Quad 2-Input NAND Gates	✓	✓	✓	✓		✓	SCLS181
CD74HC02	14	Quad 2-Input NOR Gates	✓	✓	✓				SCHS125
SN74HC02	14	Quad 2-Input NOR Gates	✓	✓	✓	✓	✓	✓	SCLS076
CD74HC03	14	Quad 2-Input NAND Gates with Open-Drain Outputs	✓	✓	✓				SCHS126
SN74HC03	14	Quad 2-Input NAND Gates with Open-Drain Outputs	✓	✓	✓	✓			SCLS077
CD74HC04	14	Hex Inverters	✓	✓	✓				SCHS117
SN74HC04	14	Hex Inverters	✓	✓	✓	✓		✓	SCLS078
CD74HCU04	14	Hex Unbuffered Inverters	✓	✓	✓				SCHS127
SN74HCU04	14	Hex Unbuffered Inverters	✓	✓	✓	✓	✓	✓	SCLS079
SN74HC05	14	Hex Inverters with Open-Drain Outputs	✓	✓	✓	✓	✓		SCLS080
CD74HC08	14	Quad 2-Input AND Gates	✓	✓	✓				SCHS118
SN74HC08	14	Quad 2-Input AND Gates	✓	✓	✓	✓		✓	SCLS081
CD74HC10	14	Triple 3-Input NAND Gates	✓	✓	✓				SCHS128
SN74HC10	14	Triple 3-Input NAND Gates	✓	✓	✓	✓		✓	SCLS083
CD74HC11	14	Triple 3-Input AND Gates	✓	✓	✓				SCHS273
SN74HC11	14	Triple 3-Input AND Gates	✓	✓	✓	✓		✓	SCLS084
CD74HC14	14	Hex Schmitt-Trigger Inverters	✓	✓	✓				SCHS129
SN74HC14	14	Hex Schmitt-Trigger Inverters	✓	✓	✓	✓		✓	SCLS085
CD74HC20	14	Dual 4-Input NAND Gates	✓	✓	✓				SCHS130
SN74HC20	14	Dual 4-Input NAND Gates	✓	✓	✓		✓	✓	SCLS086
CD74HC21	14	Dual 4-Input AND Gates	✓	✓	✓	✓			SCHS131
SN74HC21	14	Dual 4-Input AND Gates	✓	✓	✓			✓	SCLS087
CD74HC27	14	Triple 3-Input NOR Gates	✓	✓	✓	✓			SCHS132
SN74HC27	14	Triple 3-Input NOR Gates	✓	✓	✓	✓			SCLS088
CD74HC30	14	8-Input NAND Gates	✓	✓	✓	✓		✓	SCHS121
CD74HC32	14	Quad 2-Input OR Gates	✓	✓	✓				SCHS274
SN74HC32	14	Quad 2-Input OR Gates	✓	✓	✓	✓	✓	✓	SCLS200
CD74HC42	16	4-Line BCD to 10-Line Decimal Decoders	✓	✓	✓				SCHS133
SN74HC42	16	4-Line BCD to 10-Line Decimal Decoders	✓	✓	✓	✓			SCLS091
CD74HC73	14	Dual J-K Edge-Triggered Flip-Flops with Reset	✓	✓	✓				SCHS134
CD74HC74	14	Dual D-Type Flip-Flops with Set and Reset	✓	✓	✓				SCHS124

### commercial package description and availability

#### DSBGA (die-size ball grid array)†

YEA, YZA = 5/6/8 pins  
YEP, YZP = 5/6/8 pins

#### LFBGA (low-profile fine-pitch ball grid array)

GGM = 80/100 pins  
GKE, ZKE = 96 pins  
GKF, ZKF = 114 pins

#### VFBGA (very-thin-profile fine-pitch ball grid array)

GQN, ZQN = 20 pins  
GQL, ZQL = 56 pins (also includes 48-pin functions)

#### schedule

✓ = Now    ✚ = Planned

#### PDIP (plastic dual-in-line package)

P = 8 pins  
N = 14/16/20/24 pins  
NT = 24/28 pins

#### PLCC (plastic leaded chip carrier)

FN = 20/28/44/68/84 pins

#### SOIC (small-outline integrated circuit)

D = 8/14/16 pins  
DW = 16/18/20/24/28 pins

#### SOT (small-outline transistor)

PK = 3 pins  
DBV = 3/4/5 pins  
DCY = 4 pins  
DCK = 5/6 pins

#### QFN (quad flatpack no lead)

RGY = 14/16/20 pins  
RGQ = 56 pins

#### QFP (quad flatpack)

RC = 52 pins (FB only)  
PH = 80 pins (FIFOs only)  
PQ = 100/132 pins (FIFOs only)

#### LQFP (low-profile quad flatpack)

PZA = 80 pins

#### TQFP (plastic thin quad flatpack)

PAH = 52 pins  
PAG = 64 pins (FB only)  
PM = 64 pins  
PN = 80 pins  
PCA, PZ = 100 pins (FB only)  
PCB = 120 pins (FIFOs only)

#### SOP (small-outline package)

PS = 8 pins  
NS = 14/16/20/24 pins

#### QSOP (quarter-size small-outline package)

DBQ = 16/20/24 pins

#### SSOP (shrink small-outline package)

DCT = 8 pins  
DB = 14/16/20/24/28/30/38 pins  
DBQ = 16/20/24 pins  
DL = 28/48/56 pins

#### TSSOP (thin shrink small-outline package)

PW = 8/14/16/20/24/28 pins  
DGG = 48/56/64 pins

#### TVSOP (thin very small-outline package)

DGV = 14/16/20/24/48/56 pins  
DBB = 80/100 pins

#### VSSOP (very thin shrink small-outline package)

DCU = 8 pins

† JEDEC reference for wafer chip scale package (WCSP)

DEVICE	NO. PINS	DESCRIPTION	AVAILABILITY						LITERATURE REFERENCE
			MIL	PDIP	SOIC	SOP	SSOP	TSSOP	
SN74HC74	14	Dual D-Type Flip-Flops with Set and Reset	✓	✓	✓	✓	✓	✓	SCLS094
CD74HC75	16	Dual 2-Bit Bistable Transparent Latches	✓	✓	✓	✓		✓	SCHS135
CD74HC85	16	4-Bit Magnitude Comparators	✓	✓	✓	✓		✓	SCHS136
CD74HC86	14	Quad 2-Input Exclusive-OR Gates	✓	✓	✓				SCHS137
SN74HC86	14	Quad 2-Input Exclusive-OR Gates	✓	✓	✓	✓		✓	SCLS100
CD74HC93	14	4-Bit Binary Ripple Counters		✓	✓				SCHS138
CD74HC107	14	Dual Negative-Edge-Triggered J-K Flip-Flops with Reset	✓	✓	✓				SCHS139
CD74HC109	16	Dual Positive-Edge-Triggered J-K Flip Flops with Set and Reset	✓	✓	✓				SCHS140
SN74HC109	16	Dual Positive-Edge-Triggered J-K Flip Flops with Set and Reset	✓	✓	✓				SCLS098
CD74HC112	16	Dual Negative-Edge-Triggered J-K Flip-Flops with Set and Reset	✓	✓	✓	✓		✓	SCHS141
SN74HC112	16	Dual Negative-Edge-Triggered J-K Flip-Flops with Set and Reset	✓	✓	✓	✓			SCLS099
CD74HC123	16	Dual Retriggerable Monostable Multivibrators with Reset	✓	✓	✓	✓		✓	SCHS142
CD74HC125	14	Quad Bus Buffers with 3-State Outputs	✓	✓	✓				SCHS143
SN74HC125	14	Quad Bus Buffers with 3-State Outputs	✓	✓	✓	✓	✓		SCLS104
CD74HC126	14	Quad Bus Buffers with 3-State Outputs	✓	✓	✓				SCHS144
SN74HC126	14	Quad Bus Buffers with 3-State Outputs	✓	✓	✓	✓	✓	✓	SCLS103
CD74HC132	14	Quad 2-Input NAND Gates with Schmitt-Trigger Inputs	✓	✓	✓				SCHS145
SN74HC132	14	Quad 2-Input NAND Gates with Schmitt-Trigger Inputs	✓	✓	✓		✓	✓	SCLS034
CD74HC137	16	3-to-8 Line Decoders/Demultiplexers with Address Latches		✓		✓		✓	SCHS146
CD74HC138	16	3-to-8 Line Inverting Decoders/Demultiplexers	✓	✓	✓				SCHS147
SN74HC138	16	3-to-8 Line Inverting Decoders/Demultiplexers	✓	✓	✓	✓	✓	✓	SCLS107
CD74HC139	16	Dual 2-to-4 Line Decoders/Demultiplexers	✓	✓	✓				SCHS148
SN74HC139	16	Dual 2-to-4 Line Decoders/Demultiplexers	✓	✓	✓	✓	✓	✓	SCLS108
CD74HC147	16	10-to-4 Line Priority Encoders	✓	✓	✓	✓		✓	SCHS149
SN74HC148	16	8-to-3 Line Priority Encoders	✓	✓	✓	✓			SCLS109
CD74HC151	16	1-of-8 Data Selectors/Multiplexers	✓	✓	✓				SCHS150
SN74HC151	16	1-of-8 Data Selectors/Multiplexers	✓	✓	✓	✓		✓	SCLS110
CD74HC153	16	Dual 1-of-4 Data Selectors/Multiplexers	✓	✓	✓				SCHS151
SN74HC153	16	Dual 1-of-4 Data Selectors/Multiplexers	✓	✓	✓	✓		✓	SCLS112
CD74HC154	24	4-to-16 Line Decoders/Demultiplexers	✓	✓	✓				SCHS152
CD74HC157	16	Quad 2-to-4 Line Data Selectors/Multiplexers	✓	✓	✓				SCHS153
SN74HC157	16	Quad 2-to-4 Line Data Selectors/Multiplexers	✓	✓	✓	✓		✓	SCLS113
SN74HC158	16	Quad 2-to-4 Line Data Selectors/Multiplexers	✓	✓	✓	✓		✓	SCLS296
CD74HC161	16	Synchronous 4-Bit Binary Counters	✓	✓	✓				SCHS154
SN74HC161	16	Synchronous 4-Bit Binary Counters	✓	✓	✓	✓		✓	SCLS297
CD74HC163	16	Synchronous 4-Bit Binary Counters	✓	✓	✓				SCHS154
SN74HC163	16	Synchronous 4-Bit Binary Counters	✓	✓	✓	✓		✓	SCLS298
CD74HC164	14	8-Bit Serial-In, Parallel-Out Shift Registers	✓	✓	✓			✓	SCHS155
SN74HC164	14	8-Bit Serial-In, Parallel-Out Shift Registers	✓	✓	✓	✓		✓	SCLS115
CD74HC165	16	8-Bit Parallel-In, Serial-Out Shift Registers	✓	✓	✓				SCHS156
SN74HC165	16	8-Bit Parallel-In, Serial-Out Shift Registers	✓	✓	✓	✓	✓	✓	SCLS116
CD74HC166	16	8-Bit Parallel-Load Shift Registers	✓	✓	✓			✓	SCHS157
SN74HC166	16	8-Bit Parallel-Load Shift Registers	✓	✓	✓	✓			SCLS117
CD74HC173	16	Quad D-Type Flip-Flops with 3-State Outputs	✓	✓	✓	✓		✓	SCHS158

# DEVICE SELECTION GUIDE

## HC

DEVICE	NO. PINS	DESCRIPTION	AVAILABILITY						LITERATURE REFERENCE
			MIL	PDIP	SOIC	SOP	SSOP	TSSOP	
CD74HC174	16	Hex D-Type Flip-Flops with Clear	✓	✓	✓				SCHS159
SN74HC174	16	Hex D-Type Flip-Flops with Clear	✓	✓	✓	✓		✓	SCLS119
CD74HC175	16	Quad D-Type Flip-Flops with Clear	✓	✓	✓				SCHS160
SN74HC175	16	Quad D-Type Flip-Flops with Clear	✓	✓	✓	✓		✓	SCLS299
CD74HC190	16	Presetable Synchronous 4-Bit Up/Down BCD Decade Counters	✓	✓		✓		✓	SCHS275
CD74HC191	16	Presetable Synchronous 4-Bit Up/Down Binary Counters	✓	✓	✓				SCHS162
SN74HC191	16	Presetable Synchronous 4-Bit Up/Down Binary Counters	✓	✓	✓	✓			SCLS121
CD74HC192	16	BCD Presetable Synchronous 4-Bit Up/Down Decade Counters	✓	✓		✓		✓	SCHS163
CD74HC193	16	Presetable Synchronous 4-Bit Up/Down Binary Counters	✓	✓	✓				SCHS163
SN74HC193	16	Presetable Synchronous 4-Bit Up/Down Binary Counters	✓	✓	✓	✓		✓	SCLS122
CD74HC194	16	4-Bit Bidirectional Universal Shift Registers	✓	✓	✓	✓		✓	SCHS164
CD74HC195	16	4-Bit Parallel Access Shift Registers	✓	✓	✓	✓		✓	SCHS165
CD74HC221	16	Dual Monostable Multivibrators with Schmitt-Trigger Inputs	✓	✓	✓	✓		✓	SCHS166
CD74HC237	16	3-to-8 Line Decoders/Demultiplexers with Address Latches	✓	✓	✓	✓		✓	SCHS146
CD74HC238	16	3-to-8 Line Decoders/Demultiplexers	✓	✓	✓	✓		✓	SCHS147
CD74HC240	20	Octal Buffers/Drivers with 3-State Outputs	✓	✓	✓				SCHS167
SN74HC240	20	Octal Buffers/Drivers with 3-State Outputs	✓	✓	✓	✓		✓	SCLS128
SN74HC240A	20	Octal Buffers/Drivers with 3-State Outputs		✓				✓	Call
CD74HC241	20	Octal Buffers/Drivers with 3-State Outputs		✓	✓				SCHS167
SN74HC241	20	Octal Buffers/Drivers with 3-State Outputs	✓	✓	✓	✓		✓	SCLS300
CD74HC243	14	Quad Bus-Transceivers with 3-State Outputs	✓	✓	✓				SCHS168
CD74HC244	20	Octal Buffers and Line Drivers with 3-State Outputs	✓	✓	✓				SCHS167
SN74HC244	20	Octal Buffers and Line Drivers with 3-State Outputs	✓	✓	✓	✓	✓	✓	SCLS130
CD74HC245	20	Octal Bus Transceivers with 3-State Outputs	✓	✓	✓				SCHS119
SN74HC245	20	Octal Bus Transceivers with 3-State Outputs	✓	✓	✓	✓	✓	✓	SCLS131
CD74HC251	16	1-of-8 Data Selectors/Multiplexers with 3-State Outputs	✓	✓	✓				SCHS169
SN74HC251	16	1-of-8 Data Selectors/Multiplexers with 3-State Outputs	✓	✓	✓	✓	✓	✓	SCLS132
CD74HC253	16	Dual 1-of-4 Data Selectors/Multiplexers with 3-State Outputs		✓	✓				SCHS170
SN74HC253	16	Dual 1-of-4 Data Selectors/Multiplexers with 3-State Outputs	✓	✓	✓	✓	✓		SCLS133
CD74HC257	16	Quad 1-of-2 Data Selectors/Multiplexers with 3-State Outputs	✓	✓	✓				SCHS171
SN74HC257	16	Quad 1-of-2 Data Selectors/Multiplexers with 3-State Outputs	✓	✓	✓	✓		✓	SCLS224
CD74HC258	16	Quad 1-of-2 Data Selectors/Multiplexers with 3-State Outputs			✓				SCHS276
SN74HC258	16	Quad 1-of-2 Data Selectors/Multiplexers with 3-State Outputs		✓	✓	✓		✓	SCLS224
CD74HC259	16	8-Bit Addressable Latches	✓	✓	✓				SCHS173
SN74HC259	16	8-Bit Addressable Latches	✓	✓	✓	✓		✓	SCLS134
SN74HC266	14	Quad 2-Input Exclusive-NOR Gates with Open-Drain Outputs		✓	✓	✓			SCLS135
CD74HC273	20	Octal D-Type Flip-Flops with Clear	✓	✓	✓				SCHS174
SN74HC273	20	Octal D-Type Flip-Flops with Clear	✓	✓	✓	✓	✓	✓	SCLS136
CD74HC280	14	9-Bit Odd/Even Parity Generators/Checkers	✓	✓	✓				SCHS175
CD74HC283	16	9-Bit Binary Full Adders with Fast Carry	✓	✓	✓				SCHS176
CD74HC297	16	Digital Phase-Locked Loops	✓	✓					SCHS177
CD74HC299	20	8-Bit Universal Shift/Storage Registers	✓	✓	✓				SCHS178
CD74HC354	20	8-Line to 1-Line Data Selectors/Multiplexers/Registers	✓	✓					SCHS179
CD74HC365	16	Hex Buffers/Line Drivers with 3-State Outputs	✓	✓	✓			✓	SCHS180

DEVICE	NO. PINS	DESCRIPTION	AVAILABILITY						LITERATURE REFERENCE
			MIL	PDIP	SOIC	SOP	SSOP	TSSOP	
SN74HC365	16	Hex Buffers/Line Drivers with 3-State Outputs	✓	✓	✓	✓			SCLS308
CD74HC366	16	Hex Inverting Buffers/Line Drivers with 3-State Outputs	✓	✓	✓				SCHS180
CD74HC367	16	Hex Buffers/Line Drivers with 3-State Outputs	✓	✓	✓				SCHS181
SN74HC367	16	Hex Buffers/Line Drivers with 3-State Outputs	✓	✓	✓	✓		✓	SCLS309
CD74HC368	16	Hex Inverting Buffers/Line Drivers with 3-State Outputs	✓	✓	✓				SCHS181
SN74HC368	16	Hex Inverting Buffers/Line Drivers with 3-State Outputs	✓	✓	✓	✓	✓	✓	SCLS310
CD74HC373	20	Octal Transparent D-Type Latches with 3-State Outputs	✓	✓	✓				SCHS182
SN74HC373	20	Octal Transparent D-Type Latches with 3-State Outputs	✓	✓	✓	✓	✓	✓	SCLS140
CD74HC374	20	Octal D-Type Edge-Triggered Flip-Flops with 3-State Outputs	✓	✓	✓				SCHS183
SN74HC374	20	Octal D-Type Edge-Triggered Flip-Flops with 3-State Outputs	✓	✓	✓	✓	✓	✓	SCLS141
CD74HC377	20	Octal D-Type Flip-Flops with Enable	✓	✓	✓				SCHS184
SN74HC377	20	Octal D-Type Flip-Flops with Enable	✓	✓	✓	✓			SCLS307
CD74HC390	16	Dual 4-Bit Decade Counters		✓	✓				SCHS185
CD74HC393	14	Dual 4-Bit Binary Counters	✓	✓	✓				SCHS186
SN74HC393	14	Dual 4-Bit Binary Counters	✓	✓	✓	✓	✓	✓	SCLS143
CD74HC423	16	Dual Retriggerable Monostable Multivibrators with Reset		✓	✓	✓			SCHS142
CD74HC533	20	Octal Inverting Transparent Latches with 3-State Outputs	✓	✓					SCHS187
CD74HC534	20	Octal D-Type Inverting Flip-Flops with 3-State Outputs	✓	✓					SCHS188
CD74HC540	20	Inverting Octal Buffers and Line Drivers with 3-State Outputs	✓	✓	✓			✓	SCHS189
SN74HC540	20	Inverting Octal Buffers and Line Drivers with 3-State Outputs	✓	✓	✓	✓			SCLS007
CD74HC541	20	Octal Buffers and Line Drivers with 3-State Outputs	✓	✓	✓				SCHS189
SN74HC541	20	Octal Buffers and Line Drivers with 3-State Outputs	✓	✓	✓	✓	✓	✓	SCLS305
CD74HC563	20	Octal Inverting Transparent Latches with 3-State Outputs	✓	✓	✓				SCHS187
SN74HC563	20	Octal Inverting Transparent Latches with 3-State Outputs		✓	✓				SCLS145
CD74HC564	20	Octal D-Type Inverting Flip-Flops with 3-State Outputs	✓	✓	✓				SCHS188
CD74HC573	20	Octal Transparent D-Type Latches with 3-State Outputs	✓	✓	✓				SCHS182
SN74HC573A	20	Octal Transparent D-Type Latches with 3-State Outputs	✓	✓	✓		✓	✓	SCLS147
CD74HC574	20	Octal Edge-Triggered D-Type Flip-Flops with 3-State Outputs	✓	✓	✓				SCHS183
SN74HC574	20	Octal Edge-Triggered D-Type Flip-Flops with 3-State Outputs	✓	✓	✓	✓		✓	SCLS148
SN74HC590A	16	8-Bit Binary Counters with 3-State Output Registers	✓	✓	✓				SCLS039
SN74HC594	16	8-Bit Shift Registers with Output Registers		✓	✓				SCLS040
SN74HC595	16	8-Bit Shift Registers with 3-State Output Registers	✓	✓	✓	✓			SCLS041
CD74HC597	16	8-Bit Shift Registers with Input Latches	✓	✓	✓	✓			SCHS191
SN74HC623	20	Octal Bus Transceivers with 3-State Outputs		✓	✓	✓			SCLS149
CD74HC640	20	Octal Bus Transceivers with 3-State Outputs	✓	✓	✓				SCHS192
SN74HC640	20	Octal Bus Transceivers with 3-State Outputs	✓	✓	✓	✓		✓	SCLS303
SN74HC645	20	Octal Bus Transceivers with 3-State Outputs	✓	✓	✓	✓			SCLS304
CD74HC646	24	Octal Registered Bus Transceivers with 3-State Outputs	✓	✓	✓				SCHS193
SN74HC646	24	Octal Registered Bus Transceivers with 3-State Outputs		✓	✓				SCLS150
CD74HC652	24	Octal Bus Transceivers and Registers with 3-State Outputs		✓					SCHS194
SN74HC652	24	Octal Bus Transceivers and Registers with 3-State Outputs		✓	✓				SCLS151
CD74HC670	16	4-by-4 Register Files with 3-State Outputs	✓	✓	✓				SCHS195
SN74HC682	20	8-Bit Magnitude Comparators		✓	✓				SCLS018
SN74HC684	20	8-Bit Magnitude Comparators		✓	✓				SCLS340



# DEVICE SELECTION GUIDE

## HC

DEVICE	NO. PINS	DESCRIPTION	AVAILABILITY						LITERATURE REFERENCE
			MIL	PDIP	SOIC	SOP	SSOP	TSSOP	
CD74HC688	20	8-Bit Magnitude Comparators	✓	✓	✓	✓		✓	SCHS196
SN74HC688	20	8-Bit Magnitude Comparators	✓	✓	✓			✓	SCLS010
CD74HC4002	14	Dual 4-Input NOR Gates	✓	✓	✓	✓		✓	SCHS197
CD74HC4015	16	Dual 4-Stage Static Shift Registers	✓	✓	✓				SCHS198
CD74HC4016	14	Quad Bilateral Switches		✓	✓				SCHS199
CD74HC4017	16	Decade Counters/Dividers with 1-of-10 Decoded Outputs	✓	✓	✓	✓		✓	SCHS200
CD74HC4020	16	12-Stage Ripple-Carry Binary Counters/Dividers	✓	✓	✓				SCHS201
SN74HC4020	16	12-Stage Ripple-Carry Binary Counters/Dividers	✓	✓	✓	✓		✓	SCLS158
CD74HC4024	14	7-Stage Ripple-Carry Binary Counters/Dividers	✓	✓	✓			✓	SCHS202
CD74HC4040	16	12-Stage Ripple-Carry Binary Counters/Dividers	✓	✓	✓	✓			SCHS203
SN74HC4040	16	12-Stage Ripple-Carry Binary Counters/Dividers	✓	✓	✓	✓	✓	✓	SCLS160
CD74HC4046A	16	Micropower Phase-Locked Loops with VCO	✓	✓	✓	✓		✓	SCHS204
CD74HC4049	16	Hex Buffers/Converters	✓	✓	✓	✓		✓	SCHS205
CD74HC4050	16	Hex Buffers/Converters	✓	✓	✓	✓		✓	SCHS205
CD74HC4051	16	8-Channel Analog Multiplexers/Demultiplexers with Logic Level Conversion	✓	✓	✓	✓		✓	SCHS122
CD74HC4052	16	Dual 4-Channel Analog Multiplexers/Demultiplexers with Logic Level Conversion	✓	✓	✓	✓			SCHS122
CD74HC4053	16	Triple 2-Channel Analog Multiplexers/Demultiplexers with Logic Level Conversion	✓	✓	✓	✓		✓	SCHS122
CD74HC4059	24	Programmable Divide-by-N Counters	✓	✓	✓				SCHS206
CD74HC4060	16	14-Stage Binary-Ripple Counters/Dividers and Oscillators	✓	✓	✓			✓	SCHS207
SN74HC4060	16	14-Stage Binary-Ripple Counters/Dividers and Oscillators		✓	✓	✓		✓	SCLS161
CD74HC4066	14	Quad Bilateral Switches	✓	✓	✓				SCHS208
SN74HC4066	14	Quad Bilateral Switches		✓	✓	✓	✓	✓	SCLS325
CD74HC4067	24	Single 16-Channel Analog Multiplexers/Demultiplexers	✓	✓	✓		✓		SCHS209
CD74HC4075	14	Triple 3-Input OR Gates	✓	✓	✓	✓		✓	SCHS210
CD74HC4094	16	8-Stage Shift-and-Store Bus Registers	✓	✓	✓	✓		✓	SCHS211
CD74HC4316	16	Quad Analog Switches with Level Translation	✓	✓	✓	✓		✓	SCHS212
CD74HC4351	20	Analog 1-of-8 Multiplexers/Demultiplexers with Latch	✓	✓	✓				SCHS213
CD74HC4352	20	Analog Dual 1-of-4 Multiplexers/Demultiplexers with Latch	✓	✓					SCHS213
CD74HC4511	16	BCD to 7-Segment Latch Decoder Drivers	✓	✓	✓			✓	SCHS214
CD74HC4514	24	4-Bit Latches/4-to-16 Line Decoders	✓	✓	✓				SCHS215
CD74HC4515	24	4-Bit Latches/4-to-16 Line Decoders	✓	✓	✓				SCHS215
CD74HC4518	16	Dual BCD Up Counters		✓					SCHS216
CD74HC4520	16	Dual Binary Up Counters	✓	✓	✓				SCHS216
CD74HC4538	16	Dual Retriggerable Precision Monostable Multivibrators	✓	✓	✓	✓		✓	SCHS123
CD74HC4543	16	BCD to 7-Segment Latches/Decoders/Drivers for Liquid-Crystal Displays		✓					SCHS217
SN74HC7001	14	Quad 2-Input AND Gates with Schmitt-Trigger Inputs		✓	✓	✓			SCLS035
SN74HC7002	14	Quad 2-Input NOR Gates with Schmitt-Trigger Inputs		✓	✓	✓		✓	SCLS033
SN74HC7032	14	Quad 2-Input OR Gates with Schmitt-Trigger Inputs		✓	✓	✓			SCLS036
CD74HC7046A	16	Phase-Locked Loops with VCO and Lock Detector		✓	✓				SCHS218
CD74HC7266	14	Quad 2-Input Exclusive NOR Gates	✓	✓	✓				SCHS219
CD74HC40103	16	8-Bit Binary Presettable Synchronous Down Counters	✓	✓	✓				SCHS221

DEVICE	NO. PINS	DESCRIPTION	AVAILABILITY							LITERATURE REFERENCE
			MIL	PDIP	SOIC	SOP	SSOP	TSSOP	TVSOP	
CD74HCT00	14	Quad 2-Input NAND Gates	✓	✓	✓					SCHS116
SN74HCT00	14	Quad 2-Input NAND Gates		✓	✓	✓		✓		SCLS062
CD74HCT02	14	Quad 2-Input NOR Gates	✓	✓	✓					SCHS125
SN74HCT02	14	Quad 2-Input NOR Gates		✓	✓	✓		✓		SCLS065
CD74HCT03	14	Quad 2-Input NAND Gates with Open-Drain Outputs	✓	✓	✓					SCHS126
CD74HCT04	14	Hex Inverters	✓	✓	✓					SCHS117
SN74HCT04	14	Hex Inverters	✓	✓	✓	✓		✓		SCLS042
CD74HCT08	14	Quad 2-Input AND Gates	✓	✓	✓					SCHS118
SN74HCT08	14	Quad 2-Input AND Gates		✓	✓	✓	✓	✓		SCLS063
CD74HCT10	14	Triple 3-Input NAND Gates	✓	✓	✓					SCHS128
CD74HCT11	14	Triple 3-Input AND Gates	✓	✓	✓					SCHS273
CD74HCT14	14	Hex Schmitt-Trigger Inverters	✓	✓	✓					SCHS129
SN74HCT14	14	Hex Schmitt-Trigger Inverters	✓	✓	✓		✓	✓	✓	SCLS225
CD74HCT20	14	Dual 4-Input NAND Gates	✓	✓	✓					SCHS130
CD74HCT21	14	Dual 4-Input AND Gates		✓	✓					SCHS131
CD74HCT27	14	Triple 3-Input NOR Gates	✓	✓	✓					SCHS132
CD74HCT30	14	8-Input NAND Gates	✓	✓	✓					SCHS121
CD74HCT32	14	Quad 2-Input OR Gates	✓	✓	✓					SCHS274
SN74HCT32	14	Quad 2-Input OR Gates		✓	✓		✓	✓		SCLS064
CD74HCT42	16	4-Line BCD to 10-Line Decimal Decoders	✓	✓						SCHS133
CD74HCT73	14	Dual J-K Edge-Triggered Flip-Flops with Reset		✓	✓					SCHS134
CD74HCT74	14	Dual D-Type Flip-Flops with Set and Reset	✓	✓	✓					SCHS124
SN74HCT74	14	Dual D-Type Flip-Flops with Set and Reset		✓	✓	✓	✓	✓		SCLS169
SN74HCT74A	14	Dual D-Type Flip-Flops with Set and Reset		✓			✓	✓		Call
CD74HCT75	16	Dual 2-Bit Bistable Transparent Latches	✓	✓	✓					SCHS135
CD74HCT85	16	4-Bit Magnitude Comparators	✓	✓	✓					SCHS136
CD74HCT86	14	Quad 2-Input Exclusive-OR Gates	✓	✓	✓					SCHS137
CD74HCT93	14	4-Bit Binary Ripple Counters		✓						SCHS138
CD74HCT107	14	Dual Negative-Edge-Triggered J-K Flip-Flops with Reset		✓						SCHS139
CD74HCT109	16	Dual Positive-Edge-Triggered J-K Flip-Flops with Set and Reset	✓	✓	✓					SCHS140
CD74HCT112	16	Dual Negative-Edge-Triggered J-K Flip-Flops with Set and Reset	✓	✓						SCHS141
CD74HCT123	16	Dual Retriggerable Monostable Multivibrators with Reset	✓	✓	✓					SCHS142

**commercial package description and availability**

**DSBGA** (die-size ball grid array)†

YEA, YZA = 5/6/8 pins  
YEP, YZP = 5/6/8 pins

**LFBGA** (low-profile fine-pitch ball grid array)

GGM = 80/100 pins  
GKE, ZKE = 96 pins  
GKF, ZKF = 114 pins

**VFBGA** (very-thin-profile fine-pitch ball grid array)

GQN, ZQN = 20 pins  
GQL, ZQL = 56 pins (also includes 48-pin functions)

**schedule**

✓ = Now ✦ = Planned

**PDIP** (plastic dual-in-line package)

P = 8 pins  
N = 14/16/20/24 pins  
NT = 24/28 pins

**PLCC** (plastic leaded chip carrier)

FN = 20/28/44/68/84 pins

**SOIC** (small-outline integrated circuit)

D = 8/14/16 pins  
DW = 16/18/20/24/28 pins

**SOT** (small-outline transistor)

PK = 3 pins  
DBV = 3/4/5 pins  
DCY = 4 pins  
DCK = 5/6 pins

**QFN** (quad flatpack no lead)

RGY = 14/16/20 pins  
RGQ = 56 pins

**QFP** (quad flatpack)

RC = 52 pins (FB only)  
PH = 80 pins (FIFOs only)  
PQ = 100/132 pins (FIFOs only)

**LQFP** (low-profile quad flatpack)

PZA = 80 pins

**TQFP** (plastic thin quad flatpack)

PAH = 52 pins  
PAG = 64 pins (FB only)  
PM = 64 pins  
PN = 80 pins  
PCA, PZ = 100 pins (FB only)  
PCB = 120 pins (FIFOs only)

**SOP** (small-outline package)

PS = 8 pins  
NS = 14/16/20/24 pins

**QSOP** (quarter-size small-outline package)

DBQ = 16/20/24 pins

**SSOP** (shrink small-outline package)

DCT = 8 pins  
DB = 14/16/20/24/28/30/38 pins  
DBQ = 16/20/24 pins  
DL = 28/48/56 pins

**TSSOP** (thin shrink small-outline package)

PW = 8/14/16/20/24/28 pins  
DGG = 48/56/64 pins

**TVSOP** (thin very small-outline package)

DGV = 14/16/20/24/48/56 pins  
DBB = 80/100 pins

**VSSOP** (very thin shrink small-outline package)

DCU = 8 pins

† JEDEC reference for wafer chip scale package (WCSP)



# DEVICE SELECTION GUIDE

## HCT

DEVICE	NO. PINS	DESCRIPTION	AVAILABILITY							LITERATURE REFERENCE
			MIL	PDIP	SOIC	SOP	SSOP	TSSOP	TVSOP	
CD74HCT125	14	Quad Bus Buffers with 3-State Outputs	✓	✓	✓					SCHS143
SN74HCT125	14	Quad Bus Buffers with 3-State Outputs		✓	✓					SCLS069
CD74HCT126	14	Quad Bus Buffers with 3-State Outputs		✓	✓					SCHS144
CD74HCT132	14	Quad 2-Input NAND Gates with Schmitt-Trigger Inputs	✓	✓	✓					SCHS145
CD74HCT137	16	3-to-8 Line Decoders/Demultiplexers with Address Latches		✓	✓					SCHS146
CD74HCT138	16	3-to-8 Line Inverting Decoders/Demultiplexers	✓	✓	✓					SCHS147
SN74HCT138	16	3-to-8 Line Inverting Decoders/Demultiplexers	✓	✓	✓	✓		✓		SCLS171
CD74HCT139	16	Dual 2-to-4 Line Decoders/Demultiplexers	✓	✓	✓					SCHS148
SN74HCT139	16	Dual 2-to-4 Line Decoders/Demultiplexers		✓	✓		✓	✓		SCLS066
CD74HCT147	16	10-to-4 Line Priority Encoders		✓						SCHS149
CD74HCT151	16	1-of-8 Data Selectors/Multiplexers	✓	✓	✓					SCHS150
CD74HCT153	16	Dual 1-of-4 Data Selectors/Multiplexers	✓	✓	✓					SCHS151
CD74HCT154	24	4-to-16 Line Decoders/Demultiplexers	✓	✓	✓					SCHS152
CD74HCT157	16	Quad 2-to-4 Line Data Selectors/Multiplexers	✓	✓	✓					SCHS153
SN74HCT157	16	Quad 2-to-4 Line Data Selectors/Multiplexers		✓	✓					SCLS071
CD74HCT158	16	Quad 2-to-4 Line Data Selectors/Multiplexers	✓	✓						SCHS153
CD74HCT161	16	Synchronous 4-Bit Binary Counters	✓	✓	✓					SCHS154
CD74HCT163	16	Synchronous 4-Bit Binary Counters	✓	✓	✓					SCHS154
CD74HCT164	14	8-Bit Serial-In, Parallel-Out Shift Registers	✓	✓	✓					SCHS155
CD74HCT165	16	8-Bit Parallel-In, Serial-Out Shift Registers	✓	✓	✓					SCHS156
CD74HCT166	16	8-Bit Parallel-Load Shift Registers	✓	✓	✓					SCHS157
CD74HCT173	16	Quad D-Type Flip-Flops with 3-State Outputs	✓	✓	✓					SCHS158
CD74HCT174	16	Hex D-Type Flip-Flops with Clear	✓	✓	✓					SCHS159
CD74HCT175	16	Quad D-Type Flip-Flops with Clear	✓	✓	✓					SCHS160
CD74HCT191	16	Presetable Synchronous 4-Bit Up/Down Binary Counters	✓	✓	✓					SCHS162
CD74HCT193	16	Presetable Synchronous 4-Bit Up/Down Binary Counters	✓	✓						SCHS163
CD74HCT194	16	4-Bit Bidirectional Universal Shift Registers		✓						SCHS164
CD74HCT221	16	Dual Monostable Multivibrators with Schmitt-Trigger Inputs		✓	✓					SCHS166
CD74HCT237	16	3-to-8 Line Decoders/Demultiplexers with Address Latches		✓						SCHS146
CD74HCT238	16	3-to-8 Line Decoders/Demultiplexers	✓	✓	✓					SCHS147
CD74HCT240	20	Octal Buffers/Drivers with 3-State Outputs	✓	✓	✓					SCHS167
SN74HCT240	20	Octal Buffers/Drivers with 3-State Outputs	✓	✓	✓	✓		✓		SCLS174
CD74HCT241	20	Octal Buffers/Drivers with 3-State Outputs	✓	✓	✓					SCHS167
CD74HCT243	14	Quad Bus-Transceivers with 3-State Outputs	✓	✓	✓					SCHS168
CD74HCT244	20	Octal Buffers and Line Drivers with 3-State Outputs	✓	✓	✓					SCHS167
SN74HCT244	20	Octal Buffers and Line Drivers with 3-State Outputs	✓	✓	✓	✓	✓	✓		SCLS175
CD74HCT245	20	Octal Bus Transceivers with 3-State Outputs	✓	✓	✓					SCHS119
SN74HCT245	20	Octal Bus Transceivers with 3-State Outputs	✓	✓	✓	✓	✓	✓		SCLS020
CD74HCT251	16	1-of-8 Data Selectors/Multiplexers with 3-State Outputs	✓	✓	✓					SCHS169
CD74HCT253	16	Dual 1-of-4 Data Selectors/Multiplexers with 3-State Outputs		✓	✓					SCHS170
CD74HCT257	16	Quad 1-of-2 Data Selectors/Multiplexers with 3-State Outputs	✓	✓	✓					SCHS171
SN74HCT257	16	Quad 1-of-2 Data Selectors/Multiplexers with 3-State Outputs		✓	✓					SCLS072
CD74HCT258	16	Quad 1-of-2 Data Selectors/Multiplexers with 3-State Outputs	✓	✓						SCHS172
CD74HCT259	16	8-Bit Addressable Latches	✓	✓	✓					SCHS173

DEVICE	NO. PINS	DESCRIPTION	AVAILABILITY							LITERATURE REFERENCE
			MIL	PDIP	SOIC	SOP	SSOP	TSSOP	TVSOP	
CD74HCT273	20	Octal D-Type Flip-Flops with Clear	✓	✓	✓					SCHS174
SN74HCT273	20	Octal D-Type Flip-Flops with Clear		✓	✓	✓	✓	✓		SCLS068
CD74HCT280	14	9-Bit Odd/Even Parity Generators/Checkers	✓	✓						SCHS175
CD74HCT283	16	9-Bit Binary Full Adders with Fast Carry	✓	✓	✓					SCHS176
CD74HCT297	16	Digital Phase-Locked Loops		✓						SCHS177
CD74HCT299	20	8-Bit Universal Shift/Storage Registers	✓	✓	✓					SCHS178
CD74HCT354	20	8-Line to 1-Line Data Selectors/Multiplexers/Registers		✓						SCHS179
CD74HCT356	20	8-Line to 1-Line Data Selectors/Multiplexers/Registers		✓	✓					SCHS277
CD74HCT365	16	Hex Buffers/Line Drivers with 3-State Outputs	✓	✓	✓					SCHS180
CD74HCT367	16	Hex Buffers/Line Drivers with 3-State Outputs	✓	✓	✓					SCHS181
CD74HCT368	16	Hex Inverting Buffers/Line Drivers with 3-State Outputs		✓	✓					SCHS181
CD74HCT373	20	Octal Transparent D-Type Latches with 3-State Outputs	✓	✓	✓					SCHS182
SN74HCT373	20	Octal Transparent D-Type Latches with 3-State Outputs	✓	✓	✓	✓		✓		SCLS009
CD74HCT374	20	Octal Edge-Triggered D-Type Flip-Flops with 3-State Outputs	✓	✓	✓					SCHS183
SN74HCT374	20	Octal Edge-Triggered D-Type Flip-Flops with 3-State Outputs	✓	✓	✓	✓	✓	✓		SCLS005
CD74HCT377	20	Octal D-Type Flip-Flops with Enable	✓	✓	✓					SCHS184
SN74HCT377	20	Octal D-Type Flip-Flops with Enable		✓	✓					SCLS067
CD74HCT390	16	Dual 4-Bit Decade Counters	✓	✓	✓					SCHS185
CD74HCT393	14	Dual 4-Bit Binary Counters	✓	✓	✓					SCHS186
CD74HCT423	16	Dual Retriggerable Monostable Multivibrators with Reset	✓	✓	✓					SCHS142
CD74HCT533	20	Octal Inverting Transparent Latches with 3-State Outputs	✓	✓						SCHS187
CD74HCT534	20	Octal Inverting D-Type Flip-Flops with 3-State Outputs	✓	✓						SCHS188
CD74HCT540	20	Inverting Octal Buffers and Line Drivers with 3-State Outputs	✓	✓	✓					SCHS189
SN74HCT540	20	Inverting Octal Buffers and Line Drivers with 3-State Outputs		✓	✓					SCLS008
CD74HCT541	20	Octal Buffers and Line Drivers with 3-State Outputs	✓	✓	✓					SCHS189
SN74HCT541	20	Octal Buffers and Line Drivers with 3-State Outputs	✓	✓	✓	✓	✓	✓		SCLS306
CD74HCT563	20	Octal Inverting Transparent Latches with 3-State Outputs		✓	✓					SCHS187
CD74HCT564	20	Octal Inverting D-Type Flip-Flops with 3-State Outputs	✓	✓	✓					SCHS188
CD74HCT573	20	Octal Transparent D-Type Latches with 3-State Outputs	✓	✓	✓					SCHS182
SN74HCT573	20	Octal Transparent D-Type Latches with 3-State Outputs		✓	✓	✓	✓			SCLS176
CD74HCT574	20	Octal Edge-Triggered D-Type Flip-Flops with 3-State Outputs	✓	✓	✓					SCHS183
SN74HCT574	20	Octal Edge-Triggered D-Type Flip-Flops with 3-State Outputs		✓	✓	✓		✓		SCLS177
CD74HCT597	16	8-Bit Shift Registers with Input Latches		✓	✓					SCHS191
SN74HCT623	20	Octal Bus Transceivers with 3-State Outputs		✓	✓					SCLS016
CD74HCT640	20	Octal Bus Transceivers with 3-State Outputs	✓	✓	✓					SCHS192
SN74HCT645	20	Octal Bus Transceivers with 3-State Outputs		✓	✓	✓		✓		SCLS019
CD74HCT646	24	Octal Registered Bus Transceivers with 3-State Outputs			✓					SCHS278
SN74HCT646	24	Octal Registered Bus Transceivers with 3-State Outputs		✓	✓					SCLS178
CD74HCT652	24	Octal Bus Transceivers and Registers with 3-State Outputs			✓					SCHS194
SN74HCT652	24	Octal Bus Transceivers and Registers with 3-State Outputs		✓	✓					SCLS179
CD74HCT670	16	4-by-4 Register Files with 3-State Outputs		✓	✓					SCHS195
CD74HCT688	20	8-Bit Magnitude Comparators	✓	✓	✓					SCHS196
CD74HCT4020	16	12-Stage Ripple-Carry Binary Counters/Dividers	✓	✓	✓					SCHS201
CD74HCT4024	14	7-Stage Ripple-Carry Binary Counters/Dividers	✓		✓					SCHS202

# DEVICE SELECTION GUIDE

## HCT

DEVICE	NO. PINS	DESCRIPTION	AVAILABILITY						LITERATURE REFERENCE
			MIL	PDIP	SOIC	SOP	SSOP	TSSOP	
CD74HCT4040	16	12-Stage Ripple-Carry Binary Counters/Dividers	✓	✓	✓				SCHS203
CD74HCT4046A	16	Micropower Phase-Locked Loops with VCO	✓	✓	✓				SCHS204
CD74HCT4051	16	8-Channel Analog Multiplexers/Demultiplexers with Logic Level Conversion	✓	✓	✓				SCHS122
CD74HCT4052	16	Dual 4-Channel Analog Multiplexers/Demultiplexers with Logic Level Conversion		✓	✓				SCHS122
CD74HCT4053	16	Triple 2-Channel Analog Multiplexers/Demultiplexers with Logic Level Conversion		✓	✓			✓	SCHS122
CD74HCT4060	16	14-Stage Binary-Ripple Counters/Dividers and Oscillators	✓	✓	✓				SCHS207
CD74HCT4066	14	Quad Bilateral Switches		✓	✓				SCHS208
CD74HCT4067	24	Single 16-Channel Analog Multiplexers/Demultiplexers			✓				SCHS209
CD74HCT4075	14	Triple 3-Input OR Gates	✓	✓					SCHS210
CD74HCT4094	16	8-Stage Shift-and-Store Bus Registers		✓	✓				SCHS211
CD74HCT4316	16	Quad Analog Switches with Level Translation		✓	✓				SCHS212
CD74HCT4351	20	Analog 1-of-8 Multiplexers/Demultiplexers with Latch		✓					SCHS213
CD74HCT4511	16	BCD to 7-Segment Latch Decoder Drivers		✓					SCHS279
CD74HCT4514	24	4-Bit Latches/4-to-16 Line Decoders		✓					SCHS314
CD74HCT4515	24	4-Bit Latches/4-to-16 Line Decoders		✓					SCHS314
CD74HCT4520	16	Dual Binary Up Counters		✓	✓				SCHS216
CD74HCT4538	16	Dual Retriggerable Precision Monostable Multivibrators	✓	✓	✓				SCHS123
CD74HCT4543	16	BCD to 7-Segment Latches/Decoders/Drivers for Liquid-Crystal Displays		✓					SCHS281
CD74HCT7046A	16	Phase-Locked Loops with VCO and Lock Detector		✓	✓				SCHS218
CD74HCT40103	16	8-Bit Binary Presetable Synchronous Down Counters		✓	✓				SCHS221

## **IEEE Std 1149.1 (JTAG) Boundary-Scan Logic**

The IEEE Std 1149.1 (JTAG) boundary-scan logic family of octal, Widebus™, and scan-support functions incorporates circuitry that allows these devices and the electronic systems in which they are used to be tested without reliance on traditional probing techniques.

Bus-interface logic devices are available in BCT, ABT, and LVT technologies in the 8-, 18-, and 20-bit options of standard buffers, latches, and transceivers. The UBT™ devices, which can functionally replace 50+ standard bus-interface devices, are featured at Widebus widths (18 bits and 20 bits). Package options for these devices include plastic dual in-line package (PDIP), small-outline integrated circuit (SOIC), shrink small-outline package (SSOP), thin shrink small-outline package (TSSOP), and thin quad flatpack (TQFP). The scan-support functions include devices for controlling the test bus, performing at-speed functional testing, and partitioning the scan path into smaller, more manageable segments.

Over 40 devices, composed of a wide selection of BCT and ABT octals, ABT and LVT Widebus, and scan-support functions, are available. Bus-hold and series-damping-resistor features also are available.

See [www.ti.com/sc/jtag](http://www.ti.com/sc/jtag) for the most current data sheets.

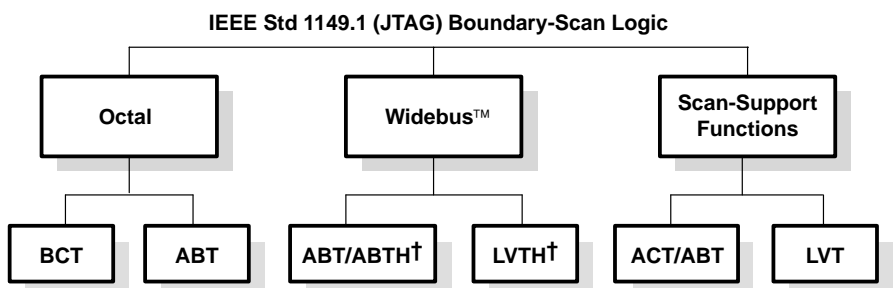

† "H" indicates bus hold

## TI IEEE Std 1149.1-Compliant Device Family and Function Cross-Reference

### Octal Bus-Interface Logic With JTAG Test Access Port (TAP)

FUNCTION	PACKAGE	PINS	BITS	ABT	BH	R	BCT	BH	R
240	DW/NT	24	8				SN74BCT8240A	N	N
244	DW/NT	24	8				SN74BCT8244A	N	N
245	DW	24	8	SN74ABT8245	N	N	SN74BCT8245A	N	N
	NT	24	8				SN74BCT8245A	N	N
373	DW/NT	24	8				SN74BCT8373A	N	N
374	DW/NT	24	8				SN74BCT8374A	N	N
543	DL/DW	28	8	SN74ABT8543	N	N			
646	DL/DW	28	8	SN74ABT8646	N	N			
652	DL/DW	28	8	SN74ABT8652	N	N			
952	DL/DW	28	8	SN74ABT8952	N	N			

### TQFP Bus-Interface Logic With JTAG TAP

FUNCTION	PACKAGE	PINS	BITS	ABT	BH	R	LVT	BH	R
16646	PM	64	2 × 9	SN74ABTH18646	Y	Y	SN74LVTH18646A	Y	Y
16652	PM	64	2 × 9	SN74ABTH18652	Y	Y	SN74LVTH18652A	Y	Y
16501	PM	64	2 × 9	SN74ABTH18502	Y	Y	SN74LVTH18502A	Y	Y
16601	PM	64	20	SN74ABTH18504	Y	Y	SN74LVTH18504A	Y	Y

### Widebus™ Bus-Interface Logic With JTAG TAP

FUNCTION	PACKAGE	PINS	BITS	ABT	BH	R	LVT	BH	R
16245	DGG/DL	56	2 × 9	SN74ABT18245A	N	N			
16640	DGG/DL	56	2 × 9	SN74ABT18640	N	N			
16501	DGG	64	2 × 9				SN74LVTH18512	B	Y
16601	DGG	64	20				SN74LVTH18514	Y	P

### JTAG Scan-Support Products

FUNCTION	PACKAGE	PINS	ABT	BH	R	ACT	BH	R	LVT	BH	R	
8980A	DW	24	Embedded Test Bus Controller							SN74LVT8980/A	N	N
8986	PM	64				10-Bit Linking Addressable Scan Ports			SN74LVT8986	N	N	
8990A	FN	44				SN74ACT8990	N	N	Test Bus Controller			
8996	DW/PW	24	SN74ABT8996	N	N	10-Bit Addressable Scan Ports			SN74LVT8996	N	N	
8997	DW	28				SN74ACT8997	N	N	Scan Path Linker			

B = both non-bus-hold and bus-hold version

BH = bus hold

N = no

P = preview

R = series-damping-resistor option

Y = yes

IEEE STD 1149.1 (JTAG) BOUNDARY-SCAN LOGIC

DEVICE	NO. PINS	DESCRIPTION	AVAILABILITY						LITERATURE REFERENCE
			MIL	PDIP	PLCC	SOIC	SSOP	TQFP	
SN74BCT8240A	24	Scan Test Devices with Octal Buffers	✓	✓		✓			SCBS067
SN74BCT8244A	24	Scan Test Devices with Octal Buffers	✓	✓		✓			SCBS042
SN74ABT8245	24	Scan Test Devices with Octal Transceivers	✓			✓			SCBS124
SN74BCT8245A	24	Scan Test Devices with Octal Transceivers	✓	✓		✓			SCBS043
SN74BCT8373A	24	Scan Test Devices with Octal D-Type Latches	✓	✓		✓			SCBS044
SN74BCT8374A	24	Scan Test Devices with Octal Edge-Triggered D-Type Flip-Flops	✓	✓		✓			SCBS045
SN74ABT8543	28	Scan Test Devices with Octal Registered Bus Transceivers	✓			✓	✓		SCBS120
SN74ABT8646	28	Scan Test Devices with Octal Bus Transceivers and Registers	✓			✓	✓		SCBS123
SN74ABT8652	28	Scan Test Devices with Octal Bus Transceivers and Registers	✓			✓	✓		SCBS122
SN74ABT8952	28	Scan Test Devices with Octal Registered Bus Transceivers				✓	✓		SCBS121
SN74LVT8980	24	Scan Test Bus Controllers with 8-Bit Generic Host Interfaces	✓			✓			SCBS676
SN74LVT8980A	24	Scan Test Bus Controllers with 8-Bit Generic Host Interfaces	✓			✓			SCBS755
SN74LVT8986	64	10-Bit Linking Addressable Scan Ports Multidrop-Addressable IEEE Std 1149.1 (JTAG) TAP Transceivers	✓					✓	SCBS759
SN74ACT8990	44	Test Bus Controllers IEEE Std 1149.1 (JTAG) TAP Masters with 16-Bit Generic Host Interfaces	✓		✓				SCBS190
SN74ABT8996	24	10-Bit Addressable Scan Ports Multidrop-Addressable IEEE Std 1149.1 (JTAG) TAP Transceivers	✓			✓		✓	SCBS489
SN74LVT8996	24	10-Bit Addressable Scan Ports Multidrop-Addressable IEEE Std 1149.1 (JTAG) TAP Transceivers				✓		✓	SCBS686
SN74ACT8997	28	Scan Path Linkers with 4-Bit Identification Buses Scan-Controlled IEEE Std 1149.1 (JTAG) TAP Concatenators	✓			✓			SCBS157
SN74ABT18245A	56	Scan Test Devices with 18-Bit Bus Transceivers	✓				✓	✓	SCBS110
SN74ABT18502	64	Scan Test Devices with 18-Bit Universal Bus Transceivers	✓					✓	SCBS109
SN74ABTH18502A	64	Scan Test Devices with 18-Bit Universal Bus Transceivers	✓					✓	SCBS164
SN74LVTH18502A	64	Scan Test Devices with 18-Bit Universal Bus Transceivers	✓					✓	SCBS668
SN74ABT18504	64	Scan Test Devices with 20-Bit Universal Bus Transceivers	✓					✓	SCBS108
SN74ABTH18504A	64	Scan Test Devices with 20-Bit Universal Bus Transceivers						✓	SCBS165
SN74LVTH18504A	64	Scan Test Devices with 20-Bit Universal Bus Transceivers						✓	SCBS667
SN74LVT18512	64	Scan Test Devices with 18-Bit Universal Bus Transceivers						✓	SCBS711
SN74LVTH18512	64	Scan Test Devices with 18-Bit Universal Bus Transceivers						✓	SCBS671
SN74LVTH18514	64	Scan Test Devices with 20-Bit Universal Bus Transceivers						✓	SCBS670
SN74ABT18640	56	Scan Test Devices with 18-Bit Inverting Bus Transceivers					✓	✓	SCBS267

commercial package description and availability

**DSBGA** (die-size ball grid array)†  
 YEA, YZA = 5/6/8 pins  
 YEP, YZP = 5/6/8 pins

**LFBGA** (low-profile fine-pitch ball grid array)  
 GGM = 80/100 pins  
 GKE, ZKE = 96 pins  
 GKF, ZKF = 114 pins

**VFBGA** (very-thin-profile fine-pitch ball grid array)  
 GQN, ZQN = 20 pins  
 GQL, ZQL = 56 pins (also includes 48-pin functions)

**schedule**

✓ = Now ✦ = Planned

† JEDEC reference for wafer chip scale package (WCSP)

**PDIP** (plastic dual-in-line package)  
 P = 8 pins  
 N = 14/16/20/24 pins  
 NT = 24/28 pins

**PLCC** (plastic leaded chip carrier)  
 FN = 20/28/44/68/84 pins

**SOIC** (small-outline integrated circuit)  
 D = 8/14/16 pins  
 DW = 16/18/20/24/28 pins

**SOT** (small-outline transistor)  
 PK = 3 pins  
 DBV = 3/4/5 pins  
 DCY = 4 pins  
 DCK = 5/6 pins

**QFN** (quad flatpack no lead)  
 RGY = 14/16/20 pins  
 RGQ = 56 pins

**QFP** (quad flatpack)  
 RC = 52 pins (FB only)  
 PH = 80 pins (FIFOs only)  
 PQ = 100/132 pins (FIFOs only)

**LQFP** (low-profile quad flatpack)  
 PZA = 80 pins

**TQFP** (plastic thin quad flatpack)  
 PAH = 52 pins  
 PAG = 64 pins (FB only)  
 PM = 64 pins  
 PN = 80 pins  
 PCA, PZ = 100 pins (FB only)  
 PCB = 120 pins (FIFOs only)

**SOP** (small-outline package)  
 PS = 8 pins  
 NS = 14/16/20/24 pins

**QSOP** (quarter-size small-outline package)  
 DBQ = 16/20/24 pins

**SSOP** (shrink small-outline package)  
 DCT = 8 pins  
 DB = 14/16/20/24/28/30/38 pins  
 DBQ = 16/20/24 pins  
 DL = 28/48/56 pins

**TSSOP** (thin shrink small-outline package)  
 PW = 8/14/16/20/24/28 pins  
 DGG = 48/56/64 pins

**TVSOP** (thin very small-outline package)  
 DGV = 14/16/20/24/48/56 pins  
 DBB = 80/100 pins

**VSSOP** (very thin shrink small-outline package)  
 DCU = 8 pins





# DEVICE SELECTION GUIDE

## IEEE STD 1149.1 (JTAG) BOUNDARY-SCAN LOGIC

DEVICE	NO. PINS	DESCRIPTION	AVAILABILITY						LITERATURE REFERENCE	
			MIL	PDIP	PLCC	SOIC	SSOP	TQFP		TSSOP
SN74ABT18646	64	Scan Test Devices with 18-Bit Transceivers and Registers	✓					✓	SCBS131	
SN74ABTH18646A	64	Scan Test Devices with 18-Bit Transceivers and Registers	✓					✓	SCBS166	
SN74LVTH18646A	64	Scan Test Devices with 18-Bit Transceivers and Registers	✓					✓	SCBS311	
SN74ABT18652	64	Scan Test Devices with 18-Bit Transceivers and Registers						✓	SCBS132	
SN74ABTH18652A	64	Scan Test Devices with 18-Bit Transceivers and Registers						✓	SCBS167	
SN74LVTH18652A	64	Scan Test Devices with 18-Bit Transceivers and Registers						✓	SCBS312	
SN74ABTH182502A	64	Scan Test Devices with 18-Bit Universal Bus Transceivers						✓	SCBS164	
SN74LVTH182502A	64	Scan Test Devices with 18-Bit Universal Bus Transceivers						✓	SCBS668	
SN74ABTH182504A	64	Scan Test Devices with 20-Bit Universal Bus Transceivers						✓	SCBS165	
SN74LVTH182504A	64	Scan Test Devices with 20-Bit Universal Bus Transceivers						✓	SCBS667	
SN74LVTH182512	64	Scan Test Devices with 18-Bit Universal Bus Transceivers							✓	SCBS671
SN74ABTH182646A	64	Scan Test Devices with 18-Bit Transceivers and Registers						✓	SCBS166	
SN74LVTH182646A	64	Scan Test Devices with 18-Bit Transceivers and Registers						✓	SCBS311	
SN74ABTH182652A	64	Scan Test Devices with 18-Bit Transceivers and Registers						✓	SCBS167	
SN74LVTH182652A	64	Scan Test Devices with 18-Bit Transceivers and Registers						✓	SCBS312	

### Little Logic

TI maintains one of the largest Little Logic portfolios in the logic industry, with a wide array of functions, families, and packaging options. With power and space concerns being prevalent in the emerging portable space, Little Logic offers the right technologies to meet these needs with NanoStar™/NanoFree™ packaging, the industry's smallest packages, and AUC, the first logic family optimized at 1.8 V.

Little Logic products are offered in the following technology families:

- AUC (advanced ultra-low-voltage CMOS logic) with 0.8-V to 2.7-V  $V_{CC}$  operation and  $I_{off}$  circuitry
- LVC (low-voltage CMOS logic) with 1.65-V to 5.5-V  $V_{CC}$  operation and  $I_{off}$  circuitry
- AHC/AHCT (advanced high-speed CMOS logic) with 2-V to 5.5-V operation in CMOS- and TTL-compatible versions
- CBT/CBTD (crossbar technology logic) with 4.5-V to 5.5-V operation, output voltage translation, and integrated level-shifting diode
- CBTLV (low-voltage crossbar technology logic) with 2.3-V to 3.6-V operation and  $I_{off}$  circuitry

Single/dual gates are available in 5-/6-pin SOT 23 and SC-70 packages, while triple gates are offered in 8-pin SM-8 and US-8 packages. TI Little Logic is also available in the world's smallest logic packages, NanoStar™ and NanoFree™ package technology.

See [www.ti.com/sc/logic](http://www.ti.com/sc/logic) for the most current data sheets.

# DEVICE SELECTION GUIDE

## LITTLE LOGIC

DEVICE	NO. PINS	DESCRIPTION	AVAILABILITY					LITERATURE REFERENCE
			DSBGA	SOP	SOT	SSOP	VSSOP	
SN74AHC1G00	5	Single 2-Input NAND Gates			✓			SCLS313
SN74AHCT1G00	5	Single 2-Input NAND Gates			✓			SCLS316
SN74AUC1G00	5	Single 2-Input NAND Gates	✓		✓			SCES368
SN74LVC1G00	5	Single 2-Input NAND Gates	✓		✓			SCES212
SN74AUC2G00	8	Dual 2-Input NAND Gates	✓		✓			SCES440
SN74LVC2G00	8	Dual 2-Input NAND Gates	✓			✓	✓	SCES193
SN74AHC1G02	5	Single 2-Input NOR Gates			✓			SCLS342
SN74AHCT1G02	5	Single 2-Input NOR Gates			✓			SCLS341
SN74AUC1G02	5	Single 2-Input NOR Gates	✓		✓			SCES369
SN74LVC1G02	5	Single 2-Input NOR Gates	✓		✓			SCES213
SN74AUC2G02	8	Dual 2-Input NOR Gates	+		✓			SCES441
SN74LVC2G02	8	Dual 2-Input NOR Gates	✓			✓	✓	SCES194
SN74AHC1G04	5	Single Inverters			✓			SCLS318
SN74AHC1GU04	5	Single Inverters			✓			SCLS343
SN74AHCT1G04	5	Single Inverters			✓			SCLS319
SN74AUC1G04	5	Single Inverter Gates	✓		✓			SCES370
SN74AUC1GU04	5	Single Inverter Gates	✓		✓			SCES371
SN74LVC1G04	5	Single Inverters	✓		✓			SCES214
SN74LVC1GU04	5	Single Inverters	✓		✓			SCES215
SN74AUC2G04	6	Dual Inverters	✓		✓			SCES437
SN74AUC2GU04	6	Dual Inverters	+		✓			SCES438
SN74LVC2G04	6	Dual Inverters	✓		✓			SCES195
SN74LVC2GU04	6	Dual Inverters	✓		✓			SCES197
SN74AUC3G04	8	Triple Inverters	+		+			Call
SN74AUC3GU04	8	Triple Inverters	+		+			Call
SN74LVC3G04	8	Triple Inverters	✓			✓	✓	SCES363
SN74LVC3GU04	8	Triple Inverters	+			+	+	Call
SN74AUC1G06	5	Single Inverter Buffers/Drivers with Open-Drain Outputs	✓		✓			SCES372
SN74LVC1G06	5	Single Inverter Buffers/Drivers with Open-Drain Outputs	✓		✓			SCES295
SN74AUC2G06	6	Dual Inverter Buffers/Drivers with Open-Drain Outputs	✓		✓			SCES442
SN74LVC2G06	6	Dual Inverter Buffers/Drivers with Open-Drain Outputs	✓		✓			SCES307
SN74AUC3G06	8	Triple Inverter Buffers/Drivers with Open-Drain Outputs	+		+			Call

### commercial package description and availability

#### DSBGA (die-size ball grid array)†

YEA, YZA = 5/6/8 pins  
YEP, YZP = 5/6/8 pins

#### LFBGA (low-profile fine-pitch ball grid array)

GGM = 80/100 pins  
GKE, ZKE = 96 pins  
GKF, ZKF = 114 pins

#### VFBGA (very-thin-profile fine-pitch ball grid array)

GQN, ZQN = 20 pins  
GQL, ZQL = 56 pins (also includes 48-pin functions)

#### schedule

✓ = Now    + = Planned

#### PDIP (plastic dual-in-line package)

P = 8 pins  
N = 14/16/20/24 pins  
NT = 24/28 pins

#### PLCC (plastic leaded chip carrier)

FN = 20/28/44/68/84 pins

#### SOIC (small-outline integrated circuit)

D = 8/14/16 pins  
DW = 16/18/20/24/28 pins

#### SOT (small-outline transistor)

PK = 3 pins  
DBV = 3/4/5 pins  
DCY = 4 pins  
DCK = 5/6 pins

#### QFN (quad flatpack no lead)

RGY = 14/16/20 pins  
RGQ = 56 pins

#### QFP (quad flatpack)

RC = 52 pins (FB only)  
PH = 80 pins (FIFOs only)  
PQ = 100/132 pins (FIFOs only)

#### LQFP (low-profile quad flatpack)

PZA = 80 pins

#### TQFP (plastic thin quad flatpack)

PAH = 52 pins  
PAG = 64 pins (FB only)  
PM = 64 pins  
PN = 80 pins  
PCA, PZ = 100 pins (FB only)  
PCB = 120 pins (FIFOs only)

#### SOP (small-outline package)

PS = 8 pins  
NS = 14/16/20/24 pins

#### QSOP (quarter-size small-outline package)

DBQ = 16/20/24 pins

#### SSOP (shrink small-outline package)

DCT = 8 pins  
DB = 14/16/20/24/28/30/38 pins  
DBQ = 16/20/24 pins  
DL = 28/48/56 pins

#### TSSOP (thin shrink small-outline package)

PW = 8/14/16/20/24/28 pins  
DGG = 48/56/64 pins

#### TVSOP (thin very small-outline package)

DGV = 14/16/20/24/48/56 pins  
DBB = 80/100 pins

#### VSSOP (very thin shrink small-outline package)

DCU = 8 pins

† JEDEC reference for wafer chip scale package (WCSP)



DEVICE	NO. PINS	DESCRIPTION	AVAILABILITY					LITERATURE REFERENCE
			DSBGA	SOP	SOT	SSOP	VSSOP	
SN74LVC3G06	8	Triple Inverter Buffers/Drivers with Open-Drain Outputs	✓			✓	✓	SCES364
SN74AUC1G07	5	Single Buffers/Drivers with Open-Drain Outputs	✓			✓		SCES373
SN74LVC1G07	5	Single Buffers/Drivers with Open-Drain Outputs	✓			✓		SCES296
SN74AUC2G07	6	Dual Buffers/Drivers with Open-Drain Outputs	✓			✓		SCES443
SN74LVC2G07	6	Dual Buffers/Drivers with Open-Drain Outputs	✓			✓		SCES308
SN74AUC3G07	8	Triple Buffers/Drivers with Open-Drain Outputs	✦			✦		Call
SN74LVC3G07	8	Triple Buffers/Drivers with Open-Drain Outputs	✓			✓	✓	SCES365
SN74AHC1G08	5	Single 2-Input AND Gates				✓		SCLS314
SN74AHCT1G08	5	Single 2-Input AND Gates				✓		SCLS315
SN74AUC1G08	5	Single 2-Input AND Gates	✓			✓		SCES374
SN74LVC1G08	5	Single 2-Input AND Gates	✓			✓		SCES217
SN74AUC2G08	8	Dual 2-Input AND Gates	✦			✦		Call
SN74LVC2G08	8	Dual 2-Input AND Gates	✓			✓	✓	SCES198
SN74AUC1G10	6	Single 3-Input Positive-NAND Gates	✦			✦		Call
SN74LVC1G10	6	Single 3-Input Positive-NAND Gates	✦			✦		Call
SN74AUC1G11	6	Single 3-Input Positive-AND Gates	✦			✦		Call
SN74LVC1G11	6	Single 3-Input Positive-AND Gates	✦			✦		Call
SN74AHC1G14	5	Single Schmitt-Trigger Inverters				✓		SCLS321
SN74AHCT1G14	5	Single Schmitt-Trigger Inverters				✓		SCLS322
SN74AUC1G14	5	Single Schmitt-Trigger Inverters	✓			✓		SCES375
SN74LVC1G14	5	Single Schmitt-Trigger Inverters	✓			✓		SCES218
SN74AUC2G14	6	Dual Schmitt-Trigger Inverters	✦			✦		Call
SN74LVC2G14	6	Dual Schmitt-Trigger Inverters	✓			✓		SCES200
SN74AUC3G14	8	Triple Schmitt-Trigger Inverters	✦			✦		Call
SN74LVC3G14	8	Triple Schmitt-Trigger Inverters	✓			✓	✓	SCES367
SN74AUC1G17	5	Single Schmitt-Trigger Buffers	✓			✓		SCES376
SN74LVC1G17	5	Single Schmitt-Trigger Buffers	✓			✓		SCES351
SN74AUC2G17	6	Dual Schmitt-Trigger Buffers	✦			✦		Call
SN74LVC2G17	6	Dual Schmitt-Trigger Buffers	✓			✓		SCES381
SN74AUC3G17	8	Triple Schmitt-Trigger Buffers	✦			✦		Call
SN74AUC1G18	6	1-of-2 Noninverting Demultiplexers with 3-State Deselected Output	✦			✦		Call
SN74LVC1G18	6	1-of-2 Noninverting Demultiplexers with 3-State Deselected Output	✓			✓		SCES406
SN74AUC1G19	6	1-of-2 Decoders/Demultiplexers	✦			✦		Call
SN74AUC1G27	6	Single 3-Input Positive-NOR Gates	✦			✦		Call
SN74LVC1G27	6	Single 3-Input Positive-NOR Gates	✦			✦		Call
SN74AHC1G32	5	Single 2-Input OR Gates				✓		SCLS317
SN74AHCT1G32	5	Single 2-Input OR Gates				✓		SCLS320
SN74AUC1G32	5	Single 2-Input-OR Gates	✓			✓		SCES377
SN74LVC1G32	5	Single 2-Input OR Gates	✓			✓		SCES219
SN74AUC2G32	8	Dual 2-Input OR Gates	✦			✦		Call
SN74LVC2G32	8	Dual 2-Input OR Gates	✓			✓	✓	SCES201
SN74AUC2G34	6	Dual Buffer Gates	✦			✦		Call
SN74LVC2G34	6	Dual Buffer Gates	✓			✓		SCES359
SN74AUC3G34	8	Triple Buffer Gates	✦			✦		Call

# DEVICE SELECTION GUIDE

## LITTLE LOGIC

DEVICE	NO. PINS	DESCRIPTION	AVAILABILITY					LITERATURE REFERENCE
			DSBGA	SOP	SOT	SSOP	VSSOP	
SN74LVC3G34	8	Triple Buffer Gates	✓			✓	✓	SCES366
SN74AUC2G53	8	Analog Multiplexers/Demultiplexers	+		+			Call
SN74LVC2G53	8	Analog Multiplexers/Demultiplexers	✓			✓	✓	SCES324
SN74AUC1G57	6	Configurable Multiple-Function Gates	+		+			Call
SN74LVC1G57	6	Configurable Multiple-Function Gates	✓			✓		SCES414
SN74AUC1G58	6	Configurable Multiple-Function Gates	+		+			Call
SN74LVC1G58	6	Configurable Multiple-Function Gates	✓			✓		SCES415
SN74AUC1G66	5	Single Bilateral Switches	✓			✓		SCES386
SN74LVC1G66	5	Single Bilateral Switches	✓			✓		SCES323
SN74AUC2G66	8	Dual Bilateral Switches	+		+			Call
SN74LVC2G66	8	Dual Bilateral Switches	✓			✓	✓	SCES325
SN74AUC2G74	8	Dual Edge-Triggered D-Type Flip-Flops with Clear and Preset	+		+			Call
SN74LVC2G74	8	Dual Edge-Triggered D-Type Flip-Flops with Clear and Preset	✓			✓	✓	SCES203
SN74AUC1G79	5	Single Positive-Edge-Triggered D-Type Flip-Flops	✓			✓		SCES387
SN74LVC1G79	5	Single Edge-Triggered D-Type Flip-Flops	✓			✓		SCES220
SN74AUC2G79	8	Dual Positive-Edge-Triggered D-Type Flip-Flops	+		+			Call
SN74AUC1G80	5	Single Positive-Edge-Triggered D-Type Flip-Flops	✓			✓		SCES388
SN74LVC1G80	5	Single Edge-Triggered D-Type Flip-Flops	✓			✓		SCES221
SN74AUC2G80	8	Dual Positive-Edge-Triggered D-Type Flip-Flops	+		+			Call
SN74AHC1G86	5	Single 2-Input Exclusive-OR Gates				✓		SCLS323
SN74AHCT1G86	5	Single 2-Input Exclusive-OR Gates				✓		SCLS324
SN74AUC1G86	5	Single 2-Input Exclusive-OR Gates	✓	✓				SCES389
SN74LVC1G86	5	Single 2-Input Exclusive-OR Gates	✓			✓		SCES222
SN74AUC2G86	8	Dual 2-Input Exclusive-OR Gates	+		+			Call
SN74LVC2G86	8	Dual 2-Input Exclusive-OR Gates	✓			✓	✓	SCES360
SN74AUC1G97	6	Configurable Multiple-Function Gates	+		+			Call
SN74LVC1G97	6	Configurable Multiple-Function Gates	✓			✓		SCES416
SN74AUC1G98	6	Configurable Multiple-Function Gates	+		+			Call
SN74LVC1G98	6	Configurable Multiple-Function Gates	✓			✓		SCES417
SN74AHC1G125	5	Single Bus Buffers with 3-State Outputs				✓		SCLS377
SN74AHCT1G125	5	Single Bus Buffers with 3-State Outputs				✓		SCLS378
SN74AUC1G125	5	Single Bus Buffers with 3-State Outputs	✓			✓		SCES382
SN74CBT1G125	5	Single FET Bus Switches				✓		SCDS046
SN74CBTD1G125	5	Single FET Bus Switches with Level Shifting				✓		SCDS063
SN74CBTLV1G125	5	Single FET Bus Switches				✓		SCDS057
SN74LVC1G125	5	Single Bus Buffers with 3-State Outputs	✓			✓		SCES223
SN74AUC2G125	8	Dual Bus Buffer Gates with 3-State Outputs	+		+			Call
SN74LVC2G125	8	Dual Bus Buffer Gates with 3-State Outputs	✓			✓	✓	SCES204
SN74AHC1G126	5	Single Bus Buffers with 3-State Outputs				✓		SCLS379
SN74AHCT1G126	5	Single Bus Buffers with 3-State Outputs				✓		SCLS380
SN74AUC1G126	5	Single Bus Buffers with 3-State Outputs	✓			✓		SCES383
SN74LVC1G126	5	Single Bus Buffers with 3-State Outputs	✓			✓		SCES224
SN74AUC2G126	8	Dual Bus Buffers with 3-State Outputs	+		+			Call
SN74LVC2G126	8	Dual Bus Buffers with 3-State Outputs	✓			✓	✓	SCES205



DEVICE	NO. PINS	DESCRIPTION	AVAILABILITY					LITERATURE REFERENCE
			DSBGA	SOP	SOT	SSOP	VSSOP	
SN74AUC2G157	8	Dual 2-to-1 Line Data Selectors/Multiplexers	+	+				Call
SN74LVC2G157	8	Dual 2-to-1 Line Data Selectors/Multiplexers	✓			✓	✓	SCES207
SN74AUC1G240	5	Single Buffers/Drivers with 3-State Outputs	✓		✓			SCES384
SN74LVC1G240	5	Single Buffers/Drivers with 3-State Outputs	✓		✓			SCES305
SN74AUC2G240	8	Dual Buffers/Drivers with 3-State Outputs	+	+				Call
SN74LVC2G240	8	Dual Buffers/Drivers with 3-State Outputs	✓			✓	✓	SCES208
SN74AUC2G241	8	Dual Buffers/Drivers with 3-State Outputs	+	+				Call
SN74LVC2G241	8	Dual Buffers/Drivers with 3-State Outputs	✓			✓	✓	SCES210
SN74AUC2G257	8	Dual 2-1 Line Data Selectors/Multiplexers with 3-State Outputs	+	+				Call
SN74AUC1G332	6	Single 3-Input Positive-OR Gates	+	+				Call
SN74LVC1G332	6	Single 3-Input Positive-OR Gates	+	+				Call
SN74CBT1G384	5	Single FET Bus Switches				✓		SCDS065
SN74CBTD1G384	5	Single FET Bus Switches with Level Shifting				✓		SCDS066
SN74AUC1G386	6	Single 3-Input Positive-XOR Gates	+	+				Call
SN74LVC1G386	6	Single 3-Input Positive-XOR Gates	✓		✓			SCES349
SN74LVC1G3157	6	Single-Pole Double-Throw Analog Switches	✓		✓			SCES424

# **LS**

## **Low-Power Schottky Logic**

With a wide array of functions, TI's LS family continues to offer replacement alternatives for mature systems. This classic line of devices was at the cutting edge of performance when introduced, and it continues to deliver excellent value for many of today's designs. As the world leader in logic products, TI is committed to being the last major supplier at every price-performance node.

See [www.ti.com/sc/logic](http://www.ti.com/sc/logic) for the most current data sheets.

# DEVICE SELECTION GUIDE

## LS

DEVICE	NO. PINS	DESCRIPTION	AVAILABILITY					LITERATURE REFERENCE
			MIL	PDIP	SOIC	SOP	SSOP	
SN74LS00	14	Quad 2-Input NAND Gates	✓	✓	✓	✓	✓	SDLS025
SN74LS00	8	Quad 2-Input NAND Gates	✓			✓		SDLS026
SN74LS02	14	Quad 2-Input NOR Gates	✓	✓	✓	✓		SDLS027
SN74LS03	14	Quad 2-Input NAND Gates with Open-Collector Outputs	✓	✓	✓	✓		SDLS028
SN74LS04	14	Hex Inverters	✓	✓	✓	✓		SDLS029
SN74LS05	14	Hex Inverters with Open-Collector Outputs	✓	✓	✓	✓	✓	SDLS030
SN74LS06	14	Hex Inverter Buffers/Drivers with Open-Collector Outputs	✓	✓	✓	✓	✓	SDLS020
SN74LS07	14	Hex Buffers/Drivers with Open-Collector Outputs	✓	✓	✓	✓	✓	SDLS021
SN74LS08	14	Quad 2-Input AND Gates	✓	✓	✓	✓	✓	SDLS033
SN74LS09	14	Quad 2-Input AND Gates with Open-Collector Outputs	✓	✓	✓	✓		SDLS034
SN74LS10	14	Triple 3-Input NAND Gates	✓	✓	✓	✓		SDLS035
SN74LS11	14	Triple 3-Input AND Gates	✓	✓	✓	✓		SDLS131
SN74LS14	14	Hex Schmitt-Trigger Inverters	✓	✓	✓		✓	SDLS049
SN74LS19A	14	Hex Schmitt-Trigger Inverters		✓	✓	✓		SDLS138
SN74LS20	14	Dual 4-Input NAND Gates	✓	✓	✓	✓		SDLS079
SN74LS21	14	Dual 4-Input AND Gates	✓	✓	✓	✓		SDLS139
SN74LS26	14	Quad 2-Input NAND Gates	✓	✓	✓	✓		SDLS087
SN74LS27	14	Triple 3-Input NOR Gates	✓	✓	✓	✓		SDLS089
SN74LS30	14	8-Input NAND Gates	✓	✓	✓	✓		SDLS099
SN74LS31	16	Hex Delay Elements for Generating Delay Lines	✓	✓	✓	✓		SDLS157
SN74LS32	14	Quad 2-Input OR Gates	✓	✓	✓	✓		SDLS100
SN74LS33	14	Quad 2-Input NOR Gates	✓	✓	✓	✓		SDLS101
SN74LS37	14	Quad 2-Input NAND Gates	✓	✓		✓		SDLS103
SN74LS38	14	Quad 2-Input NAND Gates	✓	✓	✓	✓		SDLS105
SN74LS42	16	4-Line BCD to 10-Line Decimal Decoders	✓	✓	✓	✓		SDLS109
SN74LS47	16	BCD to 7-Segment Decoders/Drivers	✓	✓	✓	✓		SDLS111
SN74LS51	14	Dual 2-Wide 2-Input, 2-Wide 3-Input AND-OR-Invert Gates	✓	✓	✓	✓		SDLS113
SN74LS73A	14	Dual J-K Edge-Triggered Flip-Flops with Reset	✓	✓	✓			SDLS118
SN74LS74A	14	Dual D-Type Flip-Flops with Set and Reset	✓	✓	✓	✓		SDLS119
SN74LS75	16	4-Bit Bistable Latches	✓	✓	✓	✓		SDLS120
SN74LS85	16	4-Bit Magnitude Comparators	✓	✓	✓	✓		SDLS123
SN74LS86A	14	Quad 2-Input Exclusive-OR Gates	✓	✓	✓	✓		SDLS124

### commercial package description and availability

#### DSBGA (die-size ball grid array)†

YEA, YZA = 5/6/8 pins  
YEP, YZP = 5/6/8 pins

#### LFBGA (low-profile fine-pitch ball grid array)

GGM = 80/100 pins  
GKE, ZKE = 96 pins  
GKF, ZKF = 114 pins

#### VFBGA (very-thin-profile fine-pitch ball grid array)

GQN, ZQN = 20 pins  
GQL, ZQL = 56 pins (also includes 48-pin functions)

#### schedule

✓ = Now    ✚ = Planned

#### PDIP (plastic dual-in-line package)

P = 8 pins  
N = 14/16/20/24 pins  
NT = 24/28 pins

#### PLCC (plastic leaded chip carrier)

FN = 20/28/44/68/84 pins

#### SOIC (small-outline integrated circuit)

D = 8/14/16 pins  
DW = 16/18/20/24/28 pins

#### SOT (small-outline transistor)

PK = 3 pins  
DBV = 3/4/5 pins  
DCY = 4 pins  
DCK = 5/6 pins

#### QFN (quad flatpack no lead)

RGY = 14/16/20 pins  
RGQ = 56 pins

#### QFP (quad flatpack)

RC = 52 pins (FB only)  
PH = 80 pins (FIFOs only)  
PQ = 100/132 pins (FIFOs only)

#### LQFP (low-profile quad flatpack)

PZA = 80 pins

#### TQFP (plastic thin quad flatpack)

PAH = 52 pins  
PAG = 64 pins (FB only)  
PM = 64 pins  
PN = 80 pins  
PCA, PZ = 100 pins (FB only)  
PCB = 120 pins (FIFOs only)

#### SOP (small-outline package)

PS = 8 pins  
NS = 14/16/20/24 pins

#### QSOP (quarter-size small-outline package)

DBQ = 16/20/24 pins

#### SSOP (shrink small-outline package)

DCT = 8 pins  
DB = 14/16/20/24/28/30/38 pins  
DBQ = 16/20/24 pins  
DL = 28/48/56 pins

#### TSSOP (thin shrink small-outline package)

PW = 8/14/16/20/24/28 pins  
DGG = 48/56/64 pins

#### TVSOP (thin very small-outline package)

DGV = 14/16/20/24/48/56 pins  
DBB = 80/100 pins

#### VSSOP (very thin shrink small-outline package)

DCU = 8 pins

† JEDEC reference for wafer chip scale package (WCSP)





DEVICE	NO. PINS	DESCRIPTION	AVAILABILITY					LITERATURE REFERENCE
			MIL	PDIP	SOIC	SOP	SSOP	
SN74LS90	14	Decade Counters	✓	✓	✓		SDLS940	
SN74LS92	14	Divide-by-12 Counters	✓	✓	✓	✓	SDLS940	
SN74LS93	14	4-Bit Binary Counters	✓	✓	✓	✓	SDLS940	
SN74LS96	16	5-Bit Shift Registers	✓	✓	✓		SDLS946	
SN74LS107A	14	Dual Negative-Edge-Triggered J-K Flip-Flops with Reset	✓	✓	✓	✓	SDLS036	
SN74LS109A	16	Dual Positive-Edge-Triggered J-K Flip-Flops with Set and Reset	✓	✓	✓	✓	SDLS037	
SN74LS112A	16	Dual Negative-Edge-Triggered J-K Flip-Flops with Set and Reset	✓	✓	✓	✓	SDLS011	
SN74LS122	14	Retriggerable Monostable Multivibrators		✓	✓	✓	SDLS043	
SN74LS123	16	Dual Retriggerable Monostable Multivibrators with Reset	✓	✓	✓	✓	SDLS043	
SN74LS125A	14	Quad Bus Buffers with 3-State Outputs	✓	✓	✓	✓	SDLS044	
SN74LS126A	14	Quad Bus Buffers with 3-State Outputs		✓	✓	✓	SDLS044	
SN74LS132	14	Quad 2-Input NAND Gates with Schmitt-Trigger Inputs	✓	✓	✓	✓	SDLS047	
SN74LS136	14	Quad Exclusive-OR Gates with Open-Collector Outputs	✓	✓	✓	✓	SDLS048	
SN74LS138	16	3-to-8 Line Inverting Decoders/Demultiplexers	✓	✓	✓	✓	SDLS014	
SN74LS139A	16	Dual 2-to-4 Line Decoders/Demultiplexers	✓	✓	✓	✓	SDLS013	
SN74LS145	16	BCD-to-Decimal Decoders/Drivers	✓	✓	✓	✓	SDLS051	
SN74LS148	16	8-to-3 Line Priority Encoders	✓	✓	✓	✓	SDLS053	
SN74LS151	16	1-of-8 Data Selectors/Multiplexers	✓	✓	✓	✓	SDLS054	
SN74LS153	16	Dual 1-of-4 Data Selectors/Multiplexers	✓	✓	✓	✓	SDLS055	
SN74LS155A	16	Dual 2-to-4 Line Decoders/Demultiplexers	✓	✓	✓	✓	SDLS057	
SN74LS156	16	Dual 2-to-4 Line Decoders/Demultiplexers with Open-Collector Outputs	✓	✓	✓	✓	SDLS057	
SN74LS157	16	Quad 2-to-4 Line Data Selectors/Multiplexers	✓	✓	✓	✓	SDLS058	
SN74LS158	16	Quad 2-to-4 Line Data Selectors/Multiplexers	✓	✓	✓	✓	SDLS058	
SN74LS161A	16	Synchronous 4-Bit Binary Counters	✓	✓	✓	✓	SDLS060	
SN74LS163A	16	Synchronous 4-Bit Binary Counters	✓	✓	✓	✓	SDLS060	
SN74LS164	14	8-Bit Serial-In, Parallel-Out Shift Registers	✓	✓	✓	✓	SDLS061	
SN74LS165A	16	8-Bit Parallel-In, Serial-Out Shift Registers	✓	✓	✓	✓	SDLS062	
SN74LS166A	16	8-Bit Parallel-Load Shift Registers	✓	✓	✓	✓	SDLS063	
SN74LS169B	16	Synchronous 4-Bit Up/Down Binary Counters	✓	✓	✓	✓	SDLS134	
SN74LS170	16	4-by-4 Register Files with Open-Collector Outputs	✓	✓	✓		SDLS065	
SN74LS173A	16	Quad D-Type Flip-Flops with 3-State Outputs	✓	✓	✓	✓	SDLS067	
SN74LS174	16	Hex D-Type Flip-Flops with Clear	✓	✓	✓	✓	SDLS068	
SN74LS175	16	Quad D-Type Flip-Flops with Clear	✓	✓	✓	✓	SDLS068	
SN74LS181	24	Arithmetic Logic Units/Function Generators	✓	✓			SDLS136	
SN74LS191	16	Presetable Synchronous 4-Bit Up/Down Binary Counters	✓	✓	✓	✓	SDLS072	
SN74LS193	16	Presetable Synchronous 4-Bit Up/Down Binary Counters	✓	✓	✓	✓	SDLS074	
SN74LS194A	16	4-Bit Bidirectional Universal Shift Registers	✓	✓	✓		SDLS075	
SN74LS221	16	Dual Monostable Multivibrators with Schmitt-Trigger Inputs	✓	✓	✓	✓	SDLS213	
SN74LS240	20	Octal Buffers/Drivers with 3-State Outputs	✓	✓	✓	✓	SDLS144	
SN74LS241	20	Octal Buffers/Drivers with 3-State Outputs	✓	✓	✓	✓	SDLS144	
SN74LS243	14	Quad Bus Transceivers with 3-State Outputs	✓	✓	✓		SDLS145	
SN74LS244	20	Octal Buffers and Line Drivers with 3-State Outputs	✓	✓	✓	✓	SDLS144	
SN74LS245	20	Octal Bus Transceivers with 3-State Outputs	✓	✓	✓	✓	SDLS146	
SN74LS247	16	BCD to 7-Segment Decoders/Drivers with Open-Collector Outputs		✓	✓	✓	SDLS083	

# DEVICE SELECTION GUIDE

## LS

DEVICE	NO. PINS	DESCRIPTION	AVAILABILITY					LITERATURE REFERENCE
			MIL	PDIP	SOIC	SOP	SSOP	
SN74LS251	16	1-of-8 Data Selectors/Multiplexers with 3-State Outputs	✓	✓	✓	✓	SDLS085	
SN74LS253	16	Dual 1-of-4 Data Selectors/Multiplexers with 3-State Outputs	✓	✓	✓	✓	SDLS147	
SN74LS257B	16	Quad 1-of-2 Data Selectors/Multiplexers with 3-State Outputs	✓	✓	✓	✓	SDLS148	
SN74LS258B	16	Quad 1-of-2 Data Selectors/Multiplexers with 3-State Outputs	✓	✓	✓	✓	SDLS148	
SN74LS259B	16	8-Bit Addressable Latches	✓	✓	✓	✓	SDLS086	
SN74LS266	14	Quad 2-Input Exclusive-NOR Gates with Open-Collector Outputs	✓	✓	✓	✓	SDLS151	
SN74LS273	20	Octal D-Type Flip-Flops with Clear	✓	✓	✓	✓	SDLS090	
SN74LS279A	16	Quad $\bar{S}\bar{R}$ Latches	✓	✓	✓	✓	SDLS093	
SN74LS280	14	9-Bit Odd/Even Parity Generators/Checkers	✓	✓	✓	✓	SDLS152	
SN74LS283	16	9-Bit Binary Full Adders with Fast Carry	✓	✓	✓	✓	SDLS095	
SN74LS292	16	Programmable Frequency Dividers/Digital Timers		✓			SDLS153	
SN74LS293	14	4-Bit Binary Counters	✓	✓	✓		SDLS097	
SN74LS294	16	Programmable Frequency Dividers/Digital Timers		✓			SDLS153	
SN74LS297	16	Digital Phase-Locked Loops		✓			SDLS155	
SN74LS298	16	Quad 2-Input Multiplexers with Storage	✓	✓	✓		SDLS098	
SN74LS299	20	8-Bit Universal Shift/Storage Registers	✓	✓	✓		SDLS156	
SN74LS321	16	Crystal-Controlled Oscillators	✓	✓			SDLS158	
SN74LS348	16	8-Line to 3-Line Priority Encoders	✓	✓	✓	✓	SDLS161	
SN74LS365A	16	Hex Buffers/Line Drivers with 3-State Outputs	✓	✓	✓	✓	SDLS102	
SN74LS367A	16	Hex Buffers/Line Drivers with 3-State Outputs	✓	✓	✓	✓	SDLS102	
SN74LS368A	16	Hex Inverting Buffers/Line Drivers with 3-State Outputs	✓	✓	✓	✓	SDLS102	
SN74LS373	20	Octal Transparent D-Type Latches with 3-State Outputs	✓	✓	✓	✓	SDLS165	
SN74LS374	20	Octal D-Type Edge-Triggered Flip-Flops with 3-State Outputs	✓	✓	✓	✓	✓	SDLS165
SN74LS375	16	4-Bit Bistable Latches	✓	✓	✓	✓	SDLS166	
SN74LS377	20	Octal D-Type Flip-Flops with Enable	✓	✓	✓	✓	SDLS167	
SN74LS378	16	Hex D-Type Flip-Flops with Enable	✓	✓	✓	✓	SDLS167	
SN74LS390	16	Dual 4-Bit Decade Counters	✓	✓	✓	✓	SDLS107	
SN74LS393	14	Dual 4-Bit Binary Counters	✓	✓	✓	✓	SDLS107	
SN74LS399	16	Quad 2-Input Multiplexers with Storage	✓	✓	✓	✓	SDLS174	
SN74LS423	16	Dual Retriggerable Monostable Multivibrators with Reset		✓	✓	✓	SDLS175	
SN74LS442	20	Quad Tridirectional Bus Transceivers with 3-State Outputs		✓			SDLS176	
SN74LS465	20	Octal Buffers with 3-State Outputs		✓	✓		SDLS179	
SN74LS540	20	Inverting Octal Buffers and Line Drivers with 3-State Outputs	✓	✓	✓	✓	✓	SDLS180
SN74LS541	20	Octal Buffers and Line Drivers with 3-State Outputs	✓	✓	✓	✓	✓	SDLS180
SN74LS590	16	8-Bit Binary Counters with 3-State Output Registers	✓	✓	✓	✓	SDLS003	
SN74LS592	16	8-Bit Binary Counters with Input Registers	✓	✓	✓	✓	SDLS004	
SN74LS593	20	8-Bit Binary Counters with Input Registers and 3-State I/O Ports	✓	✓	✓	✓	SDLS004	
SN74LS594	16	8-Bit Shift Registers with Output Registers		✓		✓	SDLS005	
SN74LS595	16	8-Bit Shift Registers with 3-State Output Registers	✓	✓	✓	✓	SDLS006	
SN74LS596	16	8-Bit Shift Registers with 3-State Output Latches		✓			SDLS006	
SN74LS597	16	8-Bit Shift Registers with Input Latches	✓	✓	✓	✓	SDLS007	
SN74LS598	20	8-Bit Shift Registers with Input Latches and 3-State I/O Ports	✓	✓	✓		SDLS007	
SN74LS599	16	8-Bit Shift Registers with Output Registers		✓			SDLS005	
SN74LS623	20	Octal Bus Transceivers with 3-State Outputs		✓	✓	✓	SDLS185	



DEVICE	NO. PINS	DESCRIPTION	AVAILABILITY					LITERATURE REFERENCE
			MIL	PDIP	SOIC	SOP	SSOP	
SN74LS624	14	Single Voltage-Controlled Oscillators	✓	✓	✓	✓		SDLS186
SN74LS628	14	Single Voltage-Controlled Oscillators	✓	✓	✓	✓		SDLS186
SN74LS629	16	Dual Voltage-Controlled Oscillators	✓	✓	✓	✓		SDLS186
SN74LS640	20	Octal Bus Transceivers with 3-State Outputs	✓	✓	✓	✓		SDLS189
SN74LS640-1	20	Octal Bus Transceivers with 3-State Outputs		✓	✓	✓		SDLS189
SN74LS641	20	Octal Bus Transceivers with Open-Collector Outputs		✓	✓	✓		SDLS189
SN74LS641-1	20	Octal Bus Transceivers with Open-Collector Outputs		✓	✓			SDLS189
SN74LS642	20	Octal Bus Transceivers with Open-Collector Outputs		✓	✓	✓		SDLS189
SN74LS642-1	20	Octal Bus Transceivers with Open-Collector Outputs		✓	✓			SDLS189
SN74LS645	20	Octal Bus Transceivers with 3-State Outputs	✓	✓	✓	✓		SDLS189
SN74LS645-1	20	Octal Bus Transceivers with 3-State Outputs		✓	✓	✓		SDLS189
SN74LS646	24	Octal Registered Bus Transceivers with 3-State Outputs		✓	✓			SDLS190
SN74LS648	24	Octal Registered Bus Transceivers with 3-State Outputs		✓	✓			SDLS190
SN74LS652	24	Octal Bus Transceivers and Registers with 3-State Outputs		✓	✓			SDLS191
SN74LS669	16	Synchronous 4-Bit Up/Down Binary Counters	✓	✓	✓			SDLS192
SN74LS670	16	4-by-4 Register Files with 3-State Outputs	✓	✓	✓	✓		SDLS193
SN74LS673	24	16-Bit Serial In/Out with 16-Bit Parallel-Out Storage Registers	✓	✓	✓			SDLS195
SN74LS674	24	16-Bit Serial In/Out with 16-Bit Parallel-Out Storage Registers	✓	✓	✓			SDLS195
SN74LS682	20	8-Bit Magnitude Comparators	✓	✓	✓	✓		SDLS008
SN74LS684	20	8-Bit Magnitude Comparators	✓	✓	✓	✓		SDLS008
SN74LS688	20	8-Bit Magnitude Comparators	✓	✓	✓	✓		SDLS008
SN74LS697	20	Synchronous 4-Bit Up/Down Binary Counters with Output Registers and Multiplexed 3-State Outputs	✓	✓	✓	✓		SDLS199

# LV

## Low-Voltage CMOS Technology Logic

TI's entire LV family has been redesigned for better flexibility in 3.3-V or 5-V systems. New LV-A devices (e.g., 'LV00A, 'LV02A) have improved operating characteristics and new features, such as 5-V tolerance, faster performance, and partial power down.

The LV-A series of devices has expanded its voltage operation range (2-V to 5.5-V  $V_{CC}$ ), while still having a static power consumption of only 20  $\mu$ A for both bus-interface and gate functions. The LV family now has propagation delays of 5.4 ns typical at 3.3 V (SN74LV244A) and provides 8 mA of current drive. With an  $I_{off}$  specification of only 5  $\mu$ A, these devices have the capability of partially powering down. In addition, the typical output  $V_{OH}$  undershoot ( $V_{OHV}$ ) has been improved to  $>2.3$  V at 3.3-V  $V_{CC}$  for quieter operation.

New key features:

- Support mixed-mode voltage operation on all ports
- $I_{off}$  for partial power down
- 14 ns maximum at 3.3-V  $V_{CC}$  for buffers

The LV family is offered in the octal footprints, with advanced packaging such as plastic dual-in-line package (PDIP), quad flatpack no-lead (QFN) package, small-outline integrated circuit (SOIC), small-outline package (SOP), shrink small-outline package (SSOP), thin shrink small-outline package (TSSOP), and thin very small-outline package (TVSOP). Selected LV devices are offered in the MicroStar Jr.<sup>™</sup> (VFBGA) package.

See [www.ti.com/sc/logic](http://www.ti.com/sc/logic) for the most current data sheets.

# DEVICE SELECTION GUIDE

## LV

DEVICE	NO. PINS	DESCRIPTION	AVAILABILITY							LITERATURE REFERENCE	
			PDIP	QFN	SOIC	SOP	SSOP	TSSOP	TVSOP		VFBGA
SN74LV00A	14	Quad 2-Input NAND Gates		✓	✓	✓	✓	✓	✓	✓	SCLS389
SN74LV02A	14	Quad 2-Input NOR Gates		✓	✓	✓	✓	✓	✓	✓	SCLS390
SN74LV04A	14	Hex Inverters		✓	✓	✓	✓	✓	✓	✓	SCLS388
SN74LVU04A	14	Hex Unbuffered Inverters			✓	✓	✓	✓	✓	✓	SCES130
SN74LV05A	14	Hex Inverters with Open-Drain Outputs			✓	✓	✓	✓	✓	✓	SCLS391
SN74LV06A	14	Hex Inverter Buffers/Drivers with Open-Drain Outputs			✓	✓	✓	✓	✓	✓	SCES336
SN74LV07A	14	Hex Buffers/Drivers with Open-Drain Outputs			✓	✓	✓	✓	✓	✓	SCES337
SN74LV08A	14	Quad 2-Input AND Gates		✓	✓	✓	✓	✓	✓	✓	SCLS387
SN74LV10A	14	Triple 3-Input NAND Gates			✓	✓	✓	✓	✓	✓	SCES338
SN74LV11A	14	Triple 3-Input AND Gates			✓	✓	✓	✓	✓	✓	SCES345
SN74LV14A	14	Hex Schmitt-Trigger Inverters		✓	✓	✓	✓	✓	✓	✓	SCLS386
SN74LV20A	14	Dual 4-Input NAND Gates			✓	✓	✓	✓	✓	✓	SCES339
SN74LV21A	14	Dual 4-Input AND Gates			✓	✓	✓	✓	✓	✓	SCES340
SN74LV27A	14	Triple 3-Input NOR Gates			✓	✓	✓	✓	✓	✓	SCES341
SN74LV32A	14	Quad 2-Input OR Gates		✓	✓	✓	✓	✓	✓	✓	SCLS385
SN74LV74A	14	Dual D-Type Flip-Flops with Set and Reset		✓	✓	✓	✓	✓	✓	✓	SCLS381
SN74LV86A	14	Quad 2-Input Exclusive-OR Gates			✓	✓	✓	✓	✓	✓	SCLS392
SN74LV123A	16	Dual Retriggerable Monostable Multivibrators with Reset			✓	✓	✓	✓	✓	✓	SCLS393
SN74LV125A	14	Quad Bus Buffers with 3-State Outputs	✓	✓	✓	✓	✓	✓	✓	✓	SCES124
SN74LV126A	14	Quad Bus Buffers with 3-State Outputs			✓	✓	✓	✓	✓	✓	SCES131
SN74LV132A	14	Quad 2-Input NAND Gates with Schmitt-Trigger Inputs			✓	✓	✓	✓	✓	✓	SCLS394
SN74LV138A	16	3-to-8 Line Inverting Decoders/Demultiplexers		✓	✓	✓	✓	✓	✓	✓	SCLS395
SN74LV139A	16	Dual 2-to-4 Line Decoders/Demultiplexers		✓	✓	✓	✓	✓	✓	✓	SCLS396
SN74LV157A	14	Quad 2-to-4 Line Data Selectors/Multiplexers			✓	✓	✓	✓	✓	✓	SCLS397
SN74LV161A	16	Synchronous 4-Bit Binary Counters			✓	✓	✓	✓	✓	✓	SCLS404
SN74LV163A	16	Synchronous 4-Bit Binary Counters		✓	✓	✓	✓	✓	✓	✓	SCLS405
SN74LV164A	14	8-Bit Serial-In, Parallel-Out Shift Registers			✓	✓	✓	✓	✓	✓	SCLS403
SN74LV165A	16	8-Bit Parallel-In, Serial-Out Shift Registers		✓	✓	✓	✓	✓	✓	✓	SCLS402
SN74LV166A	16	8-Bit Parallel-Load Shift Registers			✓	✓	✓	✓	✓	✓	SCLS456
SN74LV174A	16	Hex D-Type Flip-Flops with Clear			✓	✓	✓	✓	✓	✓	SCLS401
SN74LV175A	16	Quad D-Type Flip-Flops with Clear			✓	✓	✓	✓	✓	✓	SCLS400

### commercial package description and availability

#### DSBGA (die-size ball grid array)†

YEA, YZA = 5/6/8 pins  
YEP, YZP = 5/6/8 pins

#### LFBGA (low-profile fine-pitch ball grid array)

GGM = 80/100 pins  
GKE, ZKE = 96 pins  
GKF, ZKF = 114 pins

#### VFBGA (very-thin-profile fine-pitch ball grid array)

GQN, ZQN = 20 pins  
GQL, ZQL = 56 pins (also includes 48-pin functions)

#### schedule

✓ = Now    ✚ = Planned

#### PDIP (plastic dual-in-line package)

P = 8 pins  
N = 14/16/20/24 pins  
NT = 24/28 pins

#### PLCC (plastic leaded chip carrier)

FN = 20/28/44/68/84 pins

#### SOIC (small-outline integrated circuit)

D = 8/14/16 pins  
DW = 16/18/20/24/28 pins

#### SOT (small-outline transistor)

PK = 3 pins  
DBV = 3/4/5 pins  
DCY = 4 pins  
DCK = 5/6 pins

#### QFN (quad flatpack no lead)

RGY = 14/16/20 pins  
RGQ = 56 pins

#### QFP (quad flatpack)

RC = 52 pins (FB only)  
PH = 80 pins (FIFOs only)  
PQ = 100/132 pins (FIFOs only)

#### LQFP (low-profile quad flatpack)

PZA = 80 pins

#### TQFP (plastic thin quad flatpack)

PAH = 52 pins  
PAG = 64 pins (FB only)  
PM = 64 pins  
PN = 80 pins  
PCA, PZ = 100 pins (FB only)  
PCB = 120 pins (FIFOs only)

#### SOP (small-outline package)

PS = 8 pins  
NS = 14/16/20/24 pins

#### QSOP (quarter-size small-outline package)

DBQ = 16/20/24 pins

#### SSOP (shrink small-outline package)

DCT = 8 pins  
DB = 14/16/20/24/28/30/38 pins  
DBQ = 16/20/24 pins  
DL = 28/48/56 pins

#### TSSOP (thin shrink small-outline package)

PW = 8/14/16/20/24/28 pins  
DGG = 48/56/64 pins

#### TVSOP (thin very small-outline package)

DGV = 14/16/20/24/48/56 pins  
DBB = 80/100 pins

#### VSSOP (very thin shrink small-outline package)

DCU = 8 pins

† JEDEC reference for wafer chip scale package (WCSP)



DEVICE	NO. PINS	DESCRIPTION	AVAILABILITY							LITERATURE REFERENCE	
			PDIP	QFN	SOIC	SOP	SSOP	TSSOP	TVSOP		VFBGA
SN74LV221A	16	Dual Monostable Multivibrators with Schmitt-Trigger Inputs			✓	✓	✓	✓	✓		SCLS450
SN74LV240A	20	Octal Buffers/Drivers with 3-State Outputs			✓	✓	✓	✓	✓		SCLS384
SN74LV244A	20	Octal Buffers and Line Drivers with 3-State Outputs		✓	✓	✓	✓	✓	✓		SCLS383
SN74LV245A	20	Octal Bus Transceivers with 3-State Outputs		✓	✓	✓	✓	✓	✓	✓	SCLS382
SN74LV273A	20	Octal D-Type Flip-Flops with Clear		✓	✓	✓	✓	✓	✓		SCLS399
SN74LV367A	16	Hex Buffers/Line Drivers with 3-State Outputs			✓	✓	✓	✓	✓		SCLS398
SN74LV373A	20	Octal Transparent D-Type Latches with 3-State Outputs		✓	✓	✓	✓	✓	✓	✓	SCLS407
SN74LV374A	20	Octal Edge-Triggered D-Type Flip-Flops with 3-State Outputs		✓	✓	✓	✓	✓	✓	✓	SCLS408
SN74LV393A	14	Dual 4-Bit Binary Counters			✓	✓	✓	✓	✓		SCLS457
SN74LV540A	20	Inverting Octal Buffers and Line Drivers with 3-State Outputs			✓	✓	✓	✓	✓		SCLS409
SN74LV541A	20	Octal Buffers and Line Drivers with 3-State Outputs		✓	✓	✓	✓	✓	✓		SCLS410
SN74LV573A	20	Octal Transparent D-Type Latches with 3-State Outputs		✓	✓	✓	✓	✓	✓	✓	SCLS411
SN74LV574A	20	Octal Edge-Triggered D-Type Flip-Flops with 3-State Outputs		✓	✓	✓	✓	✓	✓	✓	SCLS412
SN74LV594A	16	8-Bit Shift Registers with Output Registers			✓	✓	✓	✓			SCLS413
SN74LV595A	16	8-Bit Shift Registers with 3-State Output Registers		✓	✓	✓	✓	✓			SCLS414
SN74LV4040A	16	12-Stage Ripple-Carry Binary Counters/Dividers	✓	✓	✓	✓	✓	✓	✓		SCES226
SN74LV4051A	16	8-Channel Analog Multiplexers/Demultiplexers with Logic Level Conversion	✓	✓	✓	✓	✓	✓	✓		SCLS428
SN74LV4052A	16	Dual 4-Channel Analog Multiplexers/Demultiplexers with Logic Level Conversion	✓	✓	✓	✓	✓	✓	✓		SCLS429
SN74LV4053A	16	Triple 2-Channel Analog Multiplexers/Demultiplexers with Logic Level Conversion	✓	✓	✓	✓	✓	✓	✓		SCLS430
SN74LV4066A	14	Quad Bilateral Switches	✓	✓	✓	✓	✓	✓	✓		SCLS427
SN74LV161284A	48	19-Bit Bus Interfaces					✓	✓			SCLS426

## **LVC**

### **Low-Voltage CMOS Technology Logic**

TI's LVC products are specially designed for 3-V power supplies.

The LVC family is a high-performance version, with 0.8- $\mu$  CMOS process technology, 24-mA current drive, and 6.5-ns maximum propagation delays for driver operations. The LVC family includes both bus-interface and gate functions, with 60 different functions planned.

The LVC family is offered in the octal and Widebus™ footprints, with advanced packaging such as plastic dual-in-line package (PDIP), quad flatpack no-lead (QFN) package, small-outline transistor (SOT), small-outline integrated circuit (SOIC), small-outline package (SOP), shrink small-outline package (SSOP), thin shrink small-outline package (TSSOP), very small-outline package (TVSOP), and very thin shrink small-outline package (VSSOP). Selected devices are offered in NanoStar™/NanoFree™ (DSBGA) packages and the MicroStar BGA™ (LFBGA) and MicroStar Jr.™ (VFBGA) packages.

All LVC devices are available with 5-V-tolerant inputs and outputs.

An extensive line of single gates is planned in the LVC family.

See [www.ti.com/sc/logic](http://www.ti.com/sc/logic) for the most current data sheets.

# DEVICE SELECTION GUIDE

## LVC

DEVICE	NO. PINS	DESCRIPTION	AVAILABILITY													LITERATURE REFERENCE	
			DSBGA	LFBGA	PDIP	QFN	SOIC	SOP	SOT	SSOP	TSSOP	TVSOP	VFBGA	VSSOP			
SN74LVC1G00	5	Single 2-Input NAND Gates	✓							✓							SCES212
SN74LVC1G02	5	Single 2-Input NOR Gates	✓							✓							SCES213
SN74LVC1G04	5	Single Inverters	✓							✓							SCES214
SN74LVC1GU04	5	Single Inverters	✓							✓							SCES215
SN74LVC1G06	5	Single Inverting Buffers/Drivers with Open-Drain Outputs	✓							✓							SCES295
SN74LVC1G07	5	Single Buffers/Drivers with Open-Drain Outputs	✓							✓							SCES296
SN74LVC1G08	5	Single 2-Input AND Gates	✓							✓							SCES217
SN74LVC1G10	6	Single 3-Input Positive-NAND Gates	+							+							Call
SN74LVC1G11	6	Single 3-Input Positive-AND Gates	+							+							Call
SN74LVC1G14	5	Single Schmitt-Trigger Inverters	✓							✓							SCES218
SN74LVC1G17	5	Single Schmitt-Trigger Buffers	✓							✓							SCES351
SN74LVC1G18	6	1-of-2 Noninverting Demultiplexers with 3-State Deselected Output	✓							✓							SCES406
SN74LVC1G27	6	Single 3-Input Positive-NOR Gates	+							+							Call
SN74LVC1G32	5	Single 2-Input OR Gates	✓							✓							SCES219
SN74LVC1G57	6	Configurable Multiple-Function Gates	✓							✓							SCES414
SN74LVC1G58	6	Configurable Multiple-Function Gates	✓							✓							SCES415
SN74LVC1G66	5	Single Bilateral Switches	✓							✓							SCES323
SN74LVC1G79	5	Single Edge-Triggered D-Type Flip-Flops	✓							✓							SCES220

### commercial package description and availability

#### DSBGA (die-size ball grid array)†

YEA, YZA = 5/6/8 pins  
YEP, YZP = 5/6/8 pins

#### LFBGA (low-profile fine-pitch ball grid array)

GGM = 80/100 pins  
GKE, ZKE = 96 pins  
GKF, ZKF = 114 pins

#### VFBGA (very-thin-profile fine-pitch ball grid array)

GQN, ZQN = 20 pins  
GQL, ZQL = 56 pins (also includes 48-pin functions)

#### schedule

✓ = Now    + = Planned

#### PDIP (plastic dual-in-line package)

P = 8 pins  
N = 14/16/20/24 pins  
NT = 24/28 pins

#### PLCC (plastic leaded chip carrier)

FN = 20/28/44/68/84 pins

#### SOIC (small-outline integrated circuit)

D = 8/14/16 pins  
DW = 16/18/20/24/28 pins

#### SOT (small-outline transistor)

PK = 3 pins  
DBV = 3/4/5 pins  
DCY = 4 pins  
DCK = 5/6 pins

#### QFN (quad flatpack no lead)

RGY = 14/16/20 pins  
RGQ = 56 pins

#### QFP (quad flatpack)

RC = 52 pins (FB only)  
PH = 80 pins (FIFOs only)  
PQ = 100/132 pins (FIFOs only)

#### LQFP (low-profile quad flatpack)

PZA = 80 pins

#### TQFP (plastic thin quad flatpack)

PAH = 52 pins  
PAG = 64 pins (FB only)  
PM = 64 pins  
PN = 80 pins  
PCA, PZ = 100 pins (FB only)  
PCB = 120 pins (FIFOs only)

#### SOP (small-outline package)

PS = 8 pins  
NS = 14/16/20/24 pins

#### QSOP (quarter-size small-outline package)

DBQ = 16/20/24 pins

#### SSOP (shrink small-outline package)

DCT = 8 pins  
DB = 14/16/20/24/28/30/38 pins  
DBQ = 16/20/24 pins  
DL = 28/48/56 pins

#### TSSOP (thin shrink small-outline package)

PW = 8/14/16/20/24/28 pins  
DGG = 48/56/64 pins

#### TVSOP (thin very small-outline package)

DGV = 14/16/20/24/48/56 pins  
DBB = 80/100 pins

#### VSSOP (very thin shrink small-outline package)

DCU = 8 pins

† JEDEC reference for wafer chip scale package (WCSP)





DEVICE	NO. PINS	DESCRIPTION	AVAILABILITY											LITERATURE REFERENCE			
			DSBGA	LFBGA	PDIP	QFN	SOIC	SOP	SOT	SSOP	TSSOP	TVSOP	VFBGA		VSSOP		
SN74LVC1G80	5	Single Edge-Triggered D-Type Flip-Flops	✓								✓						SCES221
SN74LVC1G86	5	Single 2-Input Exclusive-OR Gates	✓								✓						SCES222
SN74LVC1G97	6	Configurable Multiple-Function Gates	✓								✓						SCES416
SN74LVC1G98	6	Configurable Multiple-Function Gates	✓								✓						SCES417
SN74LVC1G125	5	Single Bus Buffers with 3-State Outputs	✓								✓						SCES223
SN74LVC1G126	5	Single Bus Buffers with 3-State Outputs	✓								✓						SCES224
SN74LVC1G240	5	Single Buffers/Drivers with 3-State Outputs	✓								✓						SCES305
SN74LVC1G332	6	Single 3-Input Positive-OR Gates	✦								✦						Call
SN74LVC1G386	6	Single 3-Input Positive-XOR Gates	✓								✓						SCES349
SN74LVC1G3157	6	Single-Pole Double-Throw Analog Switches	✓								✓						SCES424
SN74LVC2G00	8	Dual 2-Input NAND Gates	✓									✓				✓	SCES193
SN74LVC2G02	8	Dual 2-Input NOR Gates	✓									✓				✓	SCES194
SN74LVC2G04	5	Dual Inverters	✓								✓						SCES195
SN74LVC2GU04	5	Dual Inverters	✓								✓						SCES197
SN74LVC2G06	5	Dual Inverter Buffers/Drivers with Open-Drain Outputs	✓								✓						SCES307
SN74LVC2G07	5	Dual Buffers/Drivers with Open-Drain Outputs	✓								✓						SCES308
SN74LVC2G08	8	Dual 2-Input AND Gates	✓									✓				✓	SCES198
SN74LVC2G14	6	Dual Schmitt-Trigger Inverters	✓								✓						SCES200
SN74LVC2G17	6	Dual Schmitt-Trigger Buffers	✓								✓						SCES381
SN74LVC2G32	8	Dual 2-Input OR Gates	✓									✓				✓	SCES201
SN74LVC2G34	5	Dual Buffer Gates	✓								✓						SCES359
SN74LVC2G53	8	Analog Multiplexers/Demultiplexers	✓									✓				✓	SCES324
SN74LVC2G66	8	Dual Bilateral Analog Switches	✓									✓				✓	SCES325
SN74LVC2G74	8	Dual Edge-Triggered D-Type Flip-Flops with Preset and Clear	✓									✓				✓	SCES203
SN74LVC2G86	8	Dual 2-Input Exclusive-OR Gates	✓									✓				✓	SCES360
SN74LVC2G125	8	Dual Bus Buffers with 3-State Outputs	✓								✓					✓	SCES204

# DEVICE SELECTION GUIDE

## LVC

DEVICE	NO. PINS	DESCRIPTION	AVAILABILITY											LITERATURE REFERENCE			
			DSBGA	LFBGA	PDIP	QFN	SOIC	SOP	SOT	SSOP	TSSOP	TVSOP	VFBGA		VSSOP		
SN74LVC2G126	8	Dual Bus Buffer Gates with 3-State Outputs	✓									✓				✓	SCES205
SN74LVC2G157	8	Dual 2-to-1 Line Data Selectors/Multiplexers	✓									✓				✓	SCES207
SN74LVC2G240	8	Dual Buffers/Drivers with 3-State Outputs	✓								✓	+				+	SCES208
SN74LVC2G241	8	Dual Buffers/Drivers with 3-State Outputs	✓									✓				✓	SCES210
SN74LVC3G04	8	Triple Inverters	✓									✓				✓	SCES363
SN74LVC3GU04	8	Triple Inverters	+									+				+	Call
SN74LVC3G06	8	Triple Inverting Buffers/Drivers with Open-Drain Outputs	✓										✓			✓	SCES364
SN74LVC3G07	8	Triple Buffers/Drivers with Open-Drain Outputs	✓										✓			✓	SCES365
SN74LVC3G14	8	Triple Schmitt-Trigger Inverters	✓									✓				✓	SCES367
SN74LVC3G34	8	Triple Buffer Gates	✓									✓				✓	SCES366
SN74LVC00A	14	Quad 2-Input NAND Gates					✓	✓	✓			✓	✓				SCAS279
SN74LVC02A	14	Quad 2-Input NOR Gates					✓	✓	✓			✓	✓				SCAS280
SN74LVC04A	14	Hex Inverters					✓	✓	✓			✓	✓	✓			SCAS281
SN74LVCU04A	14	Hex Unbuffered Inverters						✓	✓			✓	✓	✓			SCAS282
SN74LVC06A	14	Hex Inverter Buffers/Drivers with Open-Drain Outputs					✓	✓	✓			✓	✓	✓			SCAS596
SN74LVC07A	14	Hex Buffers/Drivers with Open-Drain Outputs					✓	✓	✓			✓	✓	✓			SCAS595
SN74LVC08A	14	Quad 2-Input AND Gates					✓	✓	✓			✓	✓				SCAS283
SN74LVC10A	14	Triple 3-Input NAND Gates					✓	✓	✓			✓	✓				SCAS284
SN74LVC14A	14	Hex Schmitt-Trigger Inverters					✓	✓	✓			✓	✓	✓			SCAS285
SN74LVC32A	14	Quad 2-Input OR Gates					✓	✓	✓			✓	✓				SCAS286
SN74LVC74A	14	Dual D-Type Flip-Flops with Set and Reset						✓	✓			✓	✓				SCAS287
SN74LVC86A	14	Quad 2-Input Exclusive-OR Gates						✓	✓			✓	✓				SCAS288
SN74LVC112A	16	Dual Negative-Edge Triggered J-K Flip-Flops with Set and Reset						✓	✓			✓	✓	✓			SCAS289
SN74LVC125A	14	Quad Bus Buffers with 3-State Outputs					✓	✓	✓			✓	✓				SCAS290
SN74LVC126A	14	Quad Bus Buffers with 3-State Outputs					✓	✓	✓			✓	✓	✓			SCAS339
SN74LVC138A	16	3-to-8 Line Inverting Decoders/Demultiplexers					✓	✓	✓			✓	✓	✓	✓		SCAS291
SN74LVC139A	16	Dual 2-to-4 Line Decoders/Demultiplexers					✓	✓	✓			✓	✓				SCAS341



DEVICE	NO. PINS	DESCRIPTION	AVAILABILITY											LITERATURE REFERENCE			
			DSBGA	LFBGA	PDIP	QFN	SOIC	SOP	SOT	SSOP	TSSOP	TVSOP	VFBGA		VSSOP		
SN74LVC157A	16	Quad 2-to-4 Line Data Selectors/Multiplexers				✓	✓	✓		✓		✓	✓				SCAS292
SN74LVC240A	20	Octal Buffers/Drivers with 3-State Outputs					✓	✓		✓		✓	✓	✓			SCAS293
SN74LVCZ240A	20	Octal Buffers/Drivers with 3-State Outputs			✓		✓	✓		✓		✓	✓	✓			SCES273
SN74LVC244A	20	Octal Buffers and Line Drivers with 3-State Outputs			✓	✓	✓	✓		✓		✓	✓	✓	✓		SCAS414
SN74LVCH244A	20	Octal Buffers and Line Drivers with 3-State Outputs					✓	✓		✓		✓	✓	✓			SCES009
SN74LVCZ244A	20	Octal Buffers and Line Drivers with 3-State Outputs			✓		✓	✓		✓		✓	✓				SCES274
SN74LVC245A	20	Octal Bus Transceivers with 3-State Outputs			✓	✓	✓	✓		✓		✓	✓	✓	✓		SCAS218
SN74LVCH245A	20	Octal Bus Transceivers with 3-State Outputs					✓	✓		✓		✓	✓	✓	✓		SCES008
SN74LVCZ245A	20	Octal Bus Transceivers with 3-State Outputs			✓		✓	✓		✓		✓	✓				SCES275
SN74LVC257A	16	Quad 1-of-2 Data Selectors/Multiplexers with 3-State Outputs				✓	✓	✓		✓		✓	✓				SCAS294
SN74LVC373A	20	Octal Transparent D-Type Latches with 3-State Outputs			✓	✓	✓	✓		✓		✓	✓	✓	✓		SCAS295
SN74LVC374A	20	Octal Edge-Triggered D-Type Flip-Flops with 3-State Outputs			✓		✓	✓		✓		✓	✓	✓			SCAS296
SN74LVC540A	20	Inverting Octal Buffers and Line Drivers with 3-State Outputs					✓	✓		✓		✓	✓	✓			SCAS297
SN74LVC541A	20	Octal Buffers and Line Drivers with 3-State Outputs					✓	✓		✓		✓	✓	✓			SCAS298
SN74LVC543A	24	Octal Registered Transceivers with 3-State Outputs					✓	✓		✓		✓	✓				SCAS299
SN74LVC573A	20	Octal Transparent D-Type Latches with 3-State Outputs			✓		✓	✓		✓		✓	✓	✓	✓		SCAS300
SN74LVC574A	20	Octal Edge-Triggered D-Type Flip-Flops with 3-State Outputs			✓		✓	✓		✓		✓	✓	✓	✓		SCAS301
SN74LVC646A	24	Octal Registered Bus Transceivers with 3-State Outputs					✓	✓		✓		✓	✓				SCAS302
SN74LVC652A	24	Octal Bus Transceivers and Registers with 3-State Outputs					✓	✓		✓		✓	✓				SCAS303

# DEVICE SELECTION GUIDE

## LVC

DEVICE	NO. PINS	DESCRIPTION	AVAILABILITY											LITERATURE REFERENCE			
			DSBGA	LFBGA	PDIP	QFN	SOIC	SOP	SOT	SSOP	TSSOP	TVSOP	VFBGA		VSSOP		
SN74LVC821A	24	10-Bit Bus-Interface Flip-Flops with 3-State Outputs					✓	✓				✓	✓	✓			SCAS304
SN74LVC823A	24	9-Bit Bus-Interface Flip-Flops with 3-State Outputs					✓	✓				✓	✓	✓			SCAS305
SN74LVC827A	24	10-Bit Buffers/Drivers with 3-State Outputs					✓	✓				✓	✓	✓			SCAS306
SN74LVC828A	24	10-Bit Buffers/Drivers with 3-State Outputs					✓	✓				✓	✓	✓			SCAS347
SN74LVC841A	24	10-Bit Bus-Interface D-Type Latches with 3-State Outputs					✓					✓	✓	✓			SCAS307
SN74LVC861A	24	10-Bit Transceivers with 3-State Outputs					✓	✓				✓	✓	✓			SCAS309
SN74LVC863A	24	9-Bit Bus Transceivers with 3-State Outputs					✓	✓				✓	✓	✓			SCAS310
SN74LVC2244A	20	Octal Buffers/Line Drivers with Series Damping Resistors and 3-State Outputs					✓	✓				✓	✓	✓			SCAS572
SN74LVCR2245A	20	Octal Bus Transceivers with Series Damping Resistors and 3-State Outputs					✓	✓				✓	✓	✓	✓		SCAS581
SN74LVC2952A	24	Octal Bus Transceivers and Registers with 3-State Outputs					✓	✓				✓	✓				SCAS311
SN74LVCC3245A	24	Octal Bus Transceivers with Adjustable Output Voltage and 3-State Outputs					✓	✓				✓	✓				SCAS585
SN74LVC4245A	24	Octal Bus Transceivers and 3.3-V to 5-V Shifters with 3-State Outputs					✓					✓	✓				SCAS375
SN74LVCC4245A	24	Octal Dual-Supply Bus Transceivers with Configurable Output Voltage and 3-State Outputs					✓	✓				✓	✓				SCAS584
SN74LVCH16240A	48	16-Bit Buffers/Drivers with 3-State Outputs											✓	✓			SCAS566
SN74LVCZ16240A	48	16-Bit Buffers/Drivers with 3-State Outputs											✓	✓	✓		SCES276
SN74LVC16244A	48	16-Bit Buffers/Drivers with 3-State Outputs											✓	✓	✓	✓	SCES061
SN74LVCH16244A	48	16-Bit Buffers/Drivers with 3-State Outputs											✓	✓	✓	✓	SCAS313
SN74LVCZ16244A	48	16-Bit Buffers/Drivers with 3-State Outputs											✓	✓	✓		SCES277
SN74LVC16245A	48	16-Bit Bus Transceivers with 3-State Outputs											✓	✓	✓	✓	SCES062



DEVICE	NO. PINS	DESCRIPTION	AVAILABILITY											LITERATURE REFERENCE		
			DSBGA	LFBGA	PDIP	QFN	SOIC	SOP	SOT	SSOP	TSSOP	TVSOP	VFBGA		VSSOP	
SN74LVCH16245A	48	16-Bit Bus Transceivers with 3-State Outputs									✓	✓	✓	✓		SCES063
SN74LVCHR16245A	48	16-Bit Bus Transceivers with 3-State Outputs									✓	✓	✓	✓		SCAS582
SN74LVCZ16245A	48	16-Bit Bus Transceivers with 3-State Outputs									✓	✓	✓			SCES278
SN74LVC16373A	48	16-Bit Transparent D-Type Latches with 3-State Outputs									✓	✓	✓	✓		SCAS662
SN74LVCH16373A	48	16-Bit Transparent D-Type Latches with 3-State Outputs									✓	✓	✓	✓		SCAS568
SN74LVC16374A	48	16-Bit Edge-Triggered D-Type Flip-Flops with 3-State Outputs									✓	✓	✓	✓		SCAS663
SN74LVCH16374A	48	16-Bit Edge-Triggered D-Type Flip-Flops with 3-State Outputs									✓	✓	✓	✓		SCAS565
SN74LVCH16540A	48	16-Bit Buffers/Drivers with 3-State Outputs									✓	✓	✓			SCAS569
SN74LVCH16541A	48	16-Bit Buffers/Drivers with 3-State Outputs									✓	✓	✓			SCAS567
SN74LVC16543	56	16-Bit Registered Transceivers with 3-State Outputs									✓	✓				Call
SN74LVCH16543A	56	16-Bit Registered Transceivers with 3-State Outputs									✓	✓	✓			SCAS317
SN74LVC16646	56	16-Bit Bus Transceivers and Registers with 3-State Outputs									✓					Call
SN74LVCH16646A	56	16-Bit Bus Transceivers and Registers with 3-State Outputs									✓	✓	✓			SCAS318
SN74LVC16652	56	16-Bit Bus Transceivers and Registers with 3-State Outputs									✓					Call
SN74LVCH16652A	56	16-Bit Bus Transceivers and Registers with 3-State Outputs									✓	✓	✓			SCAS319
SN74LVCH16901	64	18-Bit Universal Bus Transceivers with Parity Generators/Checkers										✓				SCES145
SN74LVCH16952A	56	16-Bit Registered Transceivers with 3-State Outputs									✓	✓	✓			SCAS320
SN74LVCZ32240A	96	32-Bit Buffers/Drivers with 3-State Outputs		✓												SCES421
SN74LVC32244	96	32-Bit Buffers/Drivers with 3-State Outputs		✓												SCES342

# DEVICE SELECTION GUIDE

## LVC

DEVICE	NO. PINS	DESCRIPTION	AVAILABILITY											LITERATURE REFERENCE			
			DSBGA	LFBGA	PDIP	QFN	SOIC	SOP	SOT	SSOP	TSSOP	TVSOP	VFBGA		VSSOP		
SN74LVCH32244A	96	32-Bit Buffers/Drivers with 3-State Outputs		✓													SCAS617
SN74LVZ32244A	96	32-Bit Buffers/Drivers with 3-State Outputs		✓													SCES422
SN74LVC32245	96	32-Bit Bus Transceivers with 3-State Outputs		✓													SCES343
SN74LVCH32245A	96	32-Bit Bus Transceivers with 3-State Outputs		✓													SCAS616
SN74LVCR32245A	96	32-Bit Bus Transceivers with 3-State Outputs		✓													SCES428
SN74LVC32245A	96	32-Bit Bus Transceivers with 3-State Outputs		✓													SCES423
SN74LVCH32373A	96	32-Bit Transparent D-Type Latches with 3-State Outputs		✓													SCAS618
SN74LVC32374A	96	32-Bit Edge-Triggered D-Type Flip-Flops with 3-State Outputs		✓													SCES407
SN74LVCH32374A	96	32-Bit Edge-Triggered D-Type Flip-Flops with 3-State Outputs		✓													SCAS619
SN74LVC161284	48	19-Bit Bus Interfaces									✓	✓					SCAS583
SN74LVZ161284A	48	19-Bit IEEE Std 1284 Bus Interfaces										✓					SCES358
SN74LVC162244A	48	16-Bit Buffers/Drivers with Series Damping Resistors and 3-State Outputs									✓	✓	✓	✓			SCAS664
SN74LVCH162244A	48	16-Bit Buffers/Drivers with Series Damping Resistors and 3-State Outputs									✓	✓	✓				SCAS545
SN74LVCR162245	48	16-Bit Bus Transceivers with Series Damping Resistors and 3-State Outputs									✓	✓	✓	✓			SCES047

## LVT

### Low-Voltage BiCMOS Technology Logic

LVT is a 5-V-tolerant, 3.3-V product using 0.72- $\mu$  BiCMOS technology, with performance specifications ideal for workstation, networking, and telecommunications applications. LVT delivers 3.5-ns propagation delays at 3.3 V (28% faster than ABT at 5 V), current drive of 64 mA, and pin-for-pin compatibility with existing ABT families.

LVT operates at LVTTTL signal levels in telecom and networking high-performance system point-to-point or distributed backplane applications. LVT is an excellent migration path from ABT.

In addition to popular octal and Widebus™ bus-interface devices, TI also offers UBT™ transceivers and selected functions in Widebus+™ in this low-voltage family.

Performance characteristics of the LVT family are:

- 3.3-V operation with 5-V-tolerant I/Os – Permits use in a mixed-voltage environment
- Speed – Provides high-performance with maximum propagation delays of 3.5 ns at 3.3 V for buffers
- Drive – Provides up to 64 mA of drive at 3.3-V  $V_{CC}$ , yet consumes less than 330  $\mu$ W of standby power

Additional features include:

- Hot insertion – LVT devices incorporate  $I_{off}$  and power-up 3-state (PU3S) circuitry to protect the devices in live-insertion applications and make them ideally suited for hot-insertion applications.  $I_{off}$  prevents the devices from being damaged during partial power down, and PU3S forces the outputs to the high-impedance state during power up and power down.
- Bus-hold option – Eliminates floating inputs by holding them at the last valid logic state. This eliminates the need for external pullup and pulldown resistors.

---

Additional features (continued):

- Damping-resistor option – TI implements series damping resistors on selected devices, which not only reduces overshoot and undershoot, but also matches the line impedance, minimizing ringing.
- Packaging – LVT devices are available in the quad flatpack no-lead (QFN) package, small-outline integrated circuit (SOIC), small-outline package (SOP), shrink small-outline package (SSOP), thin shrink small-outline package (TSSOP), and thin very small-outline package (TVSOP). Select devices are offered in the MicroStar BGA™ (LFBGA) and MicroStar Jr.™ (VFBGA) packages.

See [www.ti.com/sc/logic](http://www.ti.com/sc/logic) for the most current data sheets.



DEVICE	NO. PINS	DESCRIPTION	AVAILABILITY							LITERATURE REFERENCE	
			MIL	LFBGA	QFN	SOIC	SOP	SSOP	TSSOP		TVSOP
<b>LVT Octals (SN74LVTxxx, SN74LVTHxxx)</b>											
SN74LVT125	14	Quad Bus Buffers with 3-State Outputs	✓			✓	✓	✓	✓		SCBS133
SN74LVTH125	14	Quad Bus Buffers with 3-State Outputs				✓	✓	✓	✓	✓	SCBS703
SN74LVTH126	14	Quad Bus Buffers with 3-State Outputs				✓	✓	✓	✓	✓	SCBS746
SN74LVT240	20	Octal Buffers/Drivers with 3-State Outputs							✓		Call
SN74LVT240A	20	Octal Buffers/Drivers with 3-State Outputs				✓	✓	✓	✓		SCBS134
SN74LVTH240	20	Octal Buffers/Drivers with 3-State Outputs			✓	✓	✓	✓	✓	✓	SCBS679
SN74LVTH241	20	Octal Buffers/Drivers with 3-State Outputs				✓	✓	✓	✓		SCAS352
SN74LVT244B	20	Octal Buffers and Line Drivers with 3-State Outputs			✓	✓	✓	✓	✓	✓	SCAS354
SN74LVTH244A	20	Octal Buffers and Line Drivers with 3-State Outputs	✓		✓	✓	✓	✓	✓	✓	SCAS586
SN74LVT245B	20	Octal Bus Transceivers with 3-State Outputs			✓	✓	✓	✓	✓	✓	SCES004
SN74LVTH245A	20	Octal Bus Transceivers with 3-State Outputs	✓		✓	✓	✓	✓	✓	✓	SCBS130
SN74LVTR245	20	3.3-V ABT Octal Bus Transceivers with 3-State Outputs and Series Resistors					✓		✓		SCAS428
SN74LVTH273	20	Octal D-Type Flip-Flops with Clear				✓	✓	✓	✓		SCBS136
SN74LVTH373	20	Octal Transparent D-Type Latches with 3-State Outputs	✓			✓	✓	✓	✓		SCBS689
SN74LVTH374	20	Octal Edge-Triggered D-Type Flip-Flops with 3-State Outputs	✓			✓	✓	✓	✓		SCBS683
SN74LVTH540	20	Inverting Octal Buffers and Line Drivers with 3-State Outputs				✓	✓	✓	✓		SCBS681
SN74LVTH541	20	Octal Buffers and Line Drivers with 3-State Outputs				✓	✓	✓	✓		SCBS682
SN74LVTH543	24	Octal Registered Transceivers with 3-State Outputs				✓	✓	✓	✓	✓	SCBS704
SN74LVTH573	20	Octal Transparent D-Type Latches with 3-State Outputs	✓		✓	✓	✓	✓	✓	✓	SCBS687
SN74LVTH574	20	Octal Edge-Triggered D-Type Flip-Flops with 3-State Outputs	✓		✓	✓	✓	✓	✓	✓	SCBS688
SN74LVTH646	24	Octal Registered Bus Transceivers with 3-State Outputs	✓			✓	✓	✓	✓	✓	SCBS705
SN74LVTH652	24	Octal Bus Transceivers and Registers with 3-State Outputs				✓	✓	✓	✓	✓	SCBS706

**commercial package description and availability**

**DSBGA** (die-size ball grid array)†

YEA, YZA = 5/6/8 pins  
YEP, YZP = 5/6/8 pins

**LFBGA** (low-profile fine-pitch ball grid array)

GGM = 80/100 pins  
GKE, ZKE = 96 pins  
GKF, ZKF = 114 pins

**VFBGA** (very-thin-profile fine-pitch ball grid array)

GQN, ZQN = 20 pins  
GQL, ZQL = 56 pins (also includes 48-pin functions)

**schedule**

✓ = Now ✦ = Planned

**PDIP** (plastic dual-in-line package)

P = 8 pins  
N = 14/16/20/24 pins  
NT = 24/28 pins

**PLCC** (plastic leaded chip carrier)

FN = 20/28/44/68/84 pins

**SOIC** (small-outline integrated circuit)

D = 8/14/16 pins  
DW = 16/18/20/24/28 pins

**SOT** (small-outline transistor)

PK = 3 pins  
DBV = 3/4/5 pins  
DCY = 4 pins  
DCK = 5/6 pins

**QFN** (quad flatpack no lead)

RGY = 14/16/20 pins  
RGQ = 56 pins

**QFP** (quad flatpack)

RC = 52 pins (FB only)  
PH = 80 pins (FIFOs only)  
PQ = 100/132 pins (FIFOs only)

**LQFP** (low-profile quad flatpack)

PZA = 80 pins

**TQFP** (plastic thin quad flatpack)

PAH = 52 pins  
PAG = 64 pins (FB only)  
PM = 64 pins  
PN = 80 pins  
PCA, PZ = 100 pins (FB only)  
PCB = 120 pins (FIFOs only)

**SOP** (small-outline package)

PS = 8 pins  
NS = 14/16/20/24 pins

**QSOP** (quarter-size small-outline package)

DBQ = 16/20/24 pins

**SSOP** (shrink small-outline package)

DCT = 8 pins  
DB = 14/16/20/24/28/30/38 pins  
DBQ = 16/20/24 pins  
DL = 28/48/56 pins

**TSSOP** (thin shrink small-outline package)

PW = 8/14/16/20/24/28 pins  
DGG = 48/56/64 pins

**TVSOP** (thin very small-outline package)

DGV = 14/16/20/24/48/56 pins  
DBB = 80/100 pins

**VSSOP** (very thin shrink small-outline package)

DCU = 8 pins

† JEDEC reference for wafer chip scale package (WCSP)

# DEVICE SELECTION GUIDE

## LVT

DEVICE	NO. PINS	DESCRIPTION	AVAILABILITY										LITERATURE REFERENCE	
			MIL	LFBGA	QFN	SOIC	SOP	SSOP	TSSOP	TVSOP	VFBGA			
SN74LVT2952	24	Octal Bus Transceivers and Registers with 3-State Outputs									✓			SCBS152
<b>LVT Widebus™ (SN74LVTH16xxx)</b>														
SN74LVT16240	48	16-Bit Buffers/Drivers with 3-State Outputs								✓	✓			SCBS717
SN74LVTH16240	48	16-Bit Buffers/Drivers with 3-State Outputs								✓	✓			SCBS684
SN74LVTH16241	48	16-Bit Buffers/Drivers with 3-State Outputs								✓	✓			SCBS693
SN74LVT16244B	48	16-Bit Buffers/Drivers with 3-State Outputs								✓	✓	✓	✓	SCBS716
SN74LVTH16244A	48	16-Bit Buffers/Drivers with 3-State Outputs	✓							✓	✓	✓	✓	SCBS142
SN74LVT16245B	48	16-Bit Bus Transceivers with 3-State Outputs								✓	✓	✓	✓	SCBS715
SN74LVTH16245A	48	16-Bit Bus Transceivers with 3-State Outputs	✓							✓	✓	✓	✓	SCBS143
SN74LVTH16373	48	16-Bit Transparent D-Type Latches with 3-State Outputs	✓							✓	✓		✓	SCBS144
SN74LVTH16374	48	16-Bit Edge-Triggered D-Type Flip-Flops with 3-State Outputs	✓							✓	✓		✓	SCBS145
SN74LVTH16500	56	18-Bit Universal Bus Transceivers with 3-State Outputs								✓	✓		✓	SCBS701
SN74LVTH16501	56	18-Bit Universal Bus Transceivers with 3-State Outputs	✓							✓	✓			SCBS700
SN74LVTH16541	48	16-Bit Buffers/Drivers with 3-State Outputs								✓	✓			SCBS691
SN74LVTH16543	56	16-Bit Registered Transceivers with 3-State Outputs								✓	✓			SCBS699
SN74LVTH16646	56	16-Bit Bus Transceivers and Registers with 3-State Outputs								✓	✓			SCBS698
SN74LVTH16652	56	16-Bit Bus Transceivers and Registers with 3-State Outputs								✓	✓			SCBS150
SN74LVTH16835	56	18-Bit Universal Bus Drivers with 3-State Outputs								✓	✓			SCBS713
SN74LVTH16952	56	16-Bit Registered Transceivers with 3-State Outputs	✓							✓	✓			SCBS697
SN74LVTH162373	48/56	3.3-V ABT 16-Bit Transparent D-Type Latches with 3-State Outputs								✓		✓	✓	SCBS261
<b>LVT Widebus+™ (SN74LVTH32xxx)</b>														
SN74LVT32240	96	32-Bit Buffers/Drivers with 3-State Outputs		✓										SCBS747
SN74LVT32244	96	32-Bit Buffers/Drivers with 3-State Outputs		✓										SCBS748
SN74LVTH32244	96	32-Bit Buffers/Drivers with 3-State Outputs		✓										SCBS749
SN74LVT32245	96	32-Bit Bus Transceivers with 3-State Outputs												Call
SN74LVTH32245	96	32-Bit Bus Transceivers with 3-State Outputs		✓										SCBS750
SN74LVTH32373	96	32-Bit Transparent D-Type Latches with 3-State Outputs		✓										SCBS751
SN74LVTH32374	96	32-Bit Edge-Triggered D-Type Flip-Flops with 3-State Outputs		✓										SCBS752
SN74LVTH322374	96	3.3-V ABT 32-Bit Edge-Triggered D-Type Flip-Flops with 3-State Outputs		✓										SCBS754

DEVICE	NO. PINS	DESCRIPTION	AVAILABILITY							LITERATURE REFERENCE		
			MIL	LFBGA	QFN	SOIC	SOP	SSOP	TSSOP		TVSOP	VFBGA
<b>LVT Octals/Widebus™ With Series Damping Resistors (SN74LVTH2xxx, SN74LVTH162xxx)</b>												
SN74LVTH2245	20	Octal Bus Transceivers with Series Damping Resistors and 3-State Outputs				✓	✓	✓	✓	✓	SCBS707	
SN74LVTH2952	24	Octal Bus Transceivers and Registers with 3-State Outputs				✓	✓	✓	✓		SCBS710	
SN74LVT162240	48	16-Bit Buffers/Drivers with Series Damping Resistors and 3-State Outputs						✓	✓	✓	SCBS719	
SN74LVTH162240	48	16-Bit Buffers/Drivers with Series Damping Resistors and 3-State Outputs						✓	✓		SCBS685	
SN74LVTH162241	48	16-Bit Buffers/Drivers with Series Damping Resistors and 3-State Outputs						✓	✓		SCBS692	
SN74LVT162244A	48	16-Bit Buffers/Drivers with Series Damping Resistors and 3-State Outputs						✓	✓	✓	✓	SCBS718
SN74LVTH162244	48	16-Bit Buffers/Drivers with Series Damping Resistors and 3-State Outputs	✓					✓	✓		✓	SCBS258
SN74LVT162245A	48	16-Bit Bus Transceivers with Series Damping Resistors and 3-State Outputs						✓	✓		✓	SCBS714
SN74LVTH162245	48	16-Bit Bus Transceivers with Series Damping Resistors and 3-State Outputs	✓					✓	✓		✓	SCBS260
SN74LVTH162373	48	16-Bit Transparent D-Type Latches with 3-State Outputs	✓					✓	✓		✓	SCBS261
SN74LVTH162374	48	16-Bit Edge-Triggered D-Type Flip-Flops with 3-State Outputs	✓					✓	✓		✓	SCBS262
SN74LVTH162541	48	16-Bit Buffers/Drivers with 3-State Outputs						✓	✓			SCBS690

## **PCA/PCF I<sup>2</sup>C Inter-Integrated Circuit Applications**

The I<sup>2</sup>C bus is a bidirectional two-wire bus for communicating between integrated circuits. The PCA and PCF devices offered by TI are general-purpose logic to be used with the I<sup>2</sup>C or system management (SM) bus protocols.

# DEVICE SELECTION GUIDE

## PCA/PCF

DEVICE	NO. PINS	DESCRIPTION	AVAILABILITY					LITERATURE REFERENCE
			PDIP	SOIC	SSOP	TSSOP	TVSOP	
PCA8550	16	Nonvolatile 5-Bit Registers with I <sup>2</sup> C Interface		✓	✓	✓		SCPS050
PCF8574	16/20	Remote 8-Bit I/O Expanders for I <sup>2</sup> C Bus	✓	✓		✓	✓	SCPS068
PCF8574A	16/20	Remote 8-Bit I/O Expanders for I <sup>2</sup> C Bus	✓	✓		✓	✓	SCPS069

### commercial package description and availability

#### DSBGA (die-size ball grid array)†

YEA, YZA = 5/6/8 pins  
YEP, YZP = 5/6/8 pins

#### LFBGA (low-profile fine-pitch ball grid array)

GGM = 80/100 pins  
GKE, ZKE = 96 pins  
GKF, ZKF = 114 pins

#### VFBGA (very-thin-profile fine-pitch ball grid array)

GQN, ZQN = 20 pins  
GQL, ZQL = 56 pins (also includes 48-pin functions)

#### schedule

✓ = Now    ✚ = Planned

† JEDEC reference for wafer chip scale package (WCSP)

#### PDIP (plastic dual-in-line package)

P = 8 pins  
N = 14/16/20/24 pins  
NT = 24/28 pins

#### PLCC (plastic leaded chip carrier)

FN = 20/28/44/68/84 pins

#### SOIC (small-outline integrated circuit)

D = 8/14/16 pins  
DW = 16/18/20/24/28 pins

#### SOT (small-outline transistor)

PK = 3 pins  
DBV = 3/4/5 pins  
DCY = 4 pins  
DCK = 5/6 pins

#### QFN (quad flatpack no lead)

RGY = 14/16/20 pins  
RGQ = 56 pins

#### QFP (quad flatpack)

RC = 52 pins (FB only)  
PH = 80 pins (FIFOs only)  
PQ = 100/132 pins (FIFOs only)

#### LQFP (low-profile quad flatpack)

PZA = 80 pins

#### TQFP (plastic thin quad flatpack)

PAH = 52 pins  
PAG = 64 pins (FB only)  
PM = 64 pins  
PN = 80 pins  
PCA, PZ = 100 pins (FB only)  
PCB = 120 pins (FIFOs only)

#### SOP (small-outline package)

PS = 8 pins  
NS = 14/16/20/24 pins

#### QSOP (quarter-size small-outline package)

DBQ = 16/20/24 pins

#### SSOP (shrink small-outline package)

DCT = 8 pins  
DB = 14/16/20/24/28/30/38 pins  
DBQ = 16/20/24 pins  
DL = 28/48/56 pins

#### TSSOP (thin shrink small-outline package)

PW = 8/14/16/20/24/28 pins  
DGG = 48/56/64 pins

#### TVSOP (thin very small-outline package)

DGV = 14/16/20/24/48/56 pins  
DBB = 80/100 pins

#### VSSOP (very thin shrink small-outline package)

DCU = 8 pins



## **S** **Schottky Logic**

With a wide array of functions, TI's S family continues to offer replacement alternatives for mature systems. This classic line of devices was at the cutting edge of performance when introduced, and it continues to deliver excellent value for many of today's designs. As the world leader in logic products, TI is committed to being the last major supplier at every price-performance node.

See [www.ti.com/sc/logic](http://www.ti.com/sc/logic) for the most current data sheets.

# DEVICE SELECTION GUIDE

## S

DEVICE	NO. PINS	DESCRIPTION	AVAILABILITY				LITERATURE REFERENCE	
			MIL	PDIP	SOIC	SOP		SSOP
SN74S00	14	Quad 2-Input NAND Gates	✓	✓	✓			SDLS025
SN74S02	14	Quad 2-Input NOR Gates	✓	✓	✓			SDLS027
SN74S04	14	Hex Inverters	✓	✓	✓			SDLS029
SN74S05	14	Hex Inverters with Open-Collector Outputs	✓	✓	✓			SDLS030
SN74S08	14	Quad 2-Input AND Gates	✓	✓	✓			SDLS033
SN74S09	14	Quad 2-Input AND Gates with Open-Collector Outputs	✓	✓	✓			SDLS034
SN74S10	14	Triple 3-Input NAND Gates	✓	✓	✓			SDLS035
SN74S20	14	Dual 4-Input NAND Gates	✓	✓	✓			SDLS079
SN74S32	14	Quad 2-Input OR Gates	✓	✓	✓			SDLS100
SN74S37	14	Quad 2-Input NAND Gates	✓	✓	✓			SDLS103
SN74S38	14	Quad 2-Input NAND Gates	✓	✓	✓			SDLS105
SN74S51	14	Dual 2-Wide 2-Input AND-OR-Invert Gates	✓	✓	✓			SDLS113
SN74S74	14	Dual D-Type Flip-Flops with Set and Reset	✓	✓	✓			SDLS119
SN74S85	16	4-Bit Magnitude Comparators	✓	✓	✓			SDLS123
SN74S86	14	Quad 2-Input Exclusive-OR Gates	✓	✓	✓			SDLS124
SN74S112A	16	Dual Negative-Edge-Triggered J-K Flip-Flops with Set and Reset	✓	✓	✓			SDLS011
SN74S124	16	Dual Voltage Controlled Oscillators	✓	✓	✓			SDLS201
SN74S132	14	Quad 2-Input NAND Gates with Schmitt-Trigger Inputs	✓	✓	✓			SDLS047
SN74S133	16	13-Input NAND Gates	✓	✓	✓			SDLS202
SN74S138A	16	3-to-8 Line Inverting Decoders/Demultiplexers	✓	✓	✓			SDLS014
SN74S139A	16	Dual 2-to-4 Line Decoders/Demultiplexers	✓	✓	✓			SDLS013
SN74S140	14	Dual 4-Input Positive-NAND 50-Ω Line Drivers	✓	✓	✓			SDLS210
SN74S151	16	1-of-8 Data Selectors/Multiplexers	✓	✓	✓			SDLS054
SN74S157	16	Quad 2-to-4 Line Data Selectors/Multiplexers	✓	✓	✓			SDLS058
SN74S158	16	Quad 2-to-4 Line Data Selectors/Multiplexers	✓	✓	✓			SDLS058
SN74S163	16	Synchronous 4-Bit Binary Counters	✓	✓				SDLS060
SN74S174	16	Hex D-Type Flip-Flops with Clear	✓	✓				SDLS068
SN74S175	16	Quad D-Type Flip-Flops with Clear	✓	✓	✓			SDLS068
SN74S182	16	Look-Ahead Carry Generators	✓	✓				SDLS206
SN74S240	20	Octal Buffers/Drivers with 3-State Outputs	✓	✓	✓			SDLS144
SN74S241	20	Octal Buffers/Drivers with 3-State Outputs	✓	✓	✓			SDLS144
SN74S244	20	Octal Buffers and Line Drivers with 3-State Outputs	✓	✓	✓			SDLS144

### commercial package description and availability

#### DSBGA (die-size ball grid array)†

YEA, YZA = 5/6/8 pins  
YEP, YZP = 5/6/8 pins

#### LFBGA (low-profile fine-pitch ball grid array)

GGM = 80/100 pins  
GKE, ZKE = 96 pins  
GKF, ZKF = 114 pins

#### VFBGA (very-thin-profile fine-pitch ball grid array)

GQN, ZQN = 20 pins  
GQL, ZQL = 56 pins (also includes 48-pin functions)

#### schedule

✓ = Now    ✚ = Planned

#### PDIP (plastic dual-in-line package)

P = 8 pins  
N = 14/16/20/24 pins  
NT = 24/28 pins

#### PLCC (plastic leaded chip carrier)

FN = 20/28/44/68/84 pins

#### SOIC (small-outline integrated circuit)

D = 8/14/16 pins  
DW = 16/18/20/24/28 pins

#### SOT (small-outline transistor)

PK = 3 pins  
DBV = 3/4/5 pins  
DCY = 4 pins  
DCK = 5/6 pins

#### QFN (quad flatpack no lead)

RGY = 14/16/20 pins  
RGQ = 56 pins

#### QFP (quad flatpack)

RC = 52 pins (FB only)  
PH = 80 pins (FIFOs only)  
PQ = 100/132 pins (FIFOs only)

#### LQFP (low-profile quad flatpack)

PZA = 80 pins

#### TQFP (plastic thin quad flatpack)

PAH = 52 pins  
PAG = 64 pins (FB only)  
PM = 64 pins  
PN = 80 pins  
PCA, PZ = 100 pins (FB only)  
PCB = 120 pins (FIFOs only)

#### SOP (small-outline package)

PS = 8 pins  
NS = 14/16/20/24 pins

#### QSOP (quarter-size small-outline package)

DBQ = 16/20/24 pins

#### SSOP (shrink small-outline package)

DCT = 8 pins  
DB = 14/16/20/24/28/30/38 pins  
DBQ = 16/20/24 pins  
DL = 28/48/56 pins

#### TSSOP (thin shrink small-outline package)

PW = 8/14/16/20/24/28 pins  
DGG = 48/56/64 pins

#### TVSOP (thin very small-outline package)

DGV = 14/16/20/24/48/56 pins  
DBB = 80/100 pins

#### VSSOP (very thin shrink small-outline package)

DCU = 8 pins

† JEDEC reference for wafer chip scale package (WCSP)



DEVICE	NO. PINS	DESCRIPTION	AVAILABILITY					LITERATURE REFERENCE
			MIL	PDIP	SOIC	SOP	SSOP	
SN74S257	16	Quad 1-of-2 Data Selectors/Multiplexers with 3-State Outputs	✓	✓	✓			SDLS148
SN74S260	14	Dual 5-Input NOR Gates	✓	✓	✓			SDLS208
SN74S280	14	9-Bit Odd/Even Parity Generators/Checkers	✓	✓				SDLS152
SN74S283	16	9-Bit Binary Full Adders with Fast Carry	✓	✓				SDLS095
SN74S373	20	Octal Transparent D-Type Latches with 3-State Outputs	✓	✓	✓			SDLS165
SN74S374	20	Octal D-Type Edge-Triggered Flip-Flops with 3-State Outputs	✓	✓	✓			SDLS165
SN74S381	20	Arithmetic Logic Units/Function Generators	✓	✓				SDLS168
SN74S1050	16	12-Bit Schottky Barrier Diode Bus-Termination Arrays		✓	✓			SDLS015
SN74S1051	16	12-Bit Schottky Barrier Diode Bus-Termination Arrays		✓	✓	✓		SDLS018
SN74S1052	20	16-Bit Schottky Barrier Diode Bus-Termination Arrays		✓	✓	✓		SDLS016
SN74S1053	20	16-Bit Schottky Barrier Diode Bus-Termination Arrays		✓	✓	✓	✓	SDLS017



## **SSTL**

### **Stub Series-Terminated Logic**

The SSTL interface is the computer industry's leading choice for next-generation technology in high-speed memory subsystems, adopted by JESD8-8 and JESD8-9 standards developed through the Joint Electronic Device Engineering Committee (JEDEC), and endorsed by major memory-module, workstation, and PC manufacturers.

The SSTL family is optimized for 3.3-V  $V_{CC}$  operation. The SN74SSTL16837 is used for driving 3.3-V address signals from a low-voltage memory controller to SDRAMs using SSTL technology. In designs operating at greater than 75 MHz, the SN74SSTL16837 provides fast address signaling with minimal propagation delay. The SN74SSTL16837 converts LVTTTL signals from the memory controller to SSTL signals that are used by the SDRAM input pins. Initially, targeted applications using the device include workstations and servers, with eventual migration to PCs as high-speed memory subsystem technology evolves in desktop systems. For low-voltage solutions, please see the SSTV and SSTVF product lines.

## **HSTL**

### **High-Speed Transceiver Logic**

One of TI's low-voltage interface solutions is HSTL. HSTL devices accept a minimal differential input swing from 0.65 V to 0.85 V (nominally), with the outputs driving LVTTTL levels. HSTL is ideally suited for driving an address bus to two banks of memory. The HSTL input levels follow the JESD8-6 standard.

See [www.ti.com/sc/logic](http://www.ti.com/sc/logic) for the most current data sheets.

# DEVICE SELECTION GUIDE

## SSTL/HSTL

DEVICE	NO. PINS	DESCRIPTION	AVAILABILITY	LITERATURE
			TSSOP	REFERENCE
<b>SSTL</b>				
SN74SSTL16837A	64	20-Bit SSTL_3 Interface Universal Bus Drivers with 3-State Outputs	✓	SCBS675
SN74SSTL16847	64	20-Bit SSTL_3 Interface Buffers with 3-State Outputs	✓	SCBS709
SN74SSTL16857	48	14-Bit SSTL_2 Registered Buffers	✓	SCAS625
<b>HSTL</b>				
SN74HSTL16918	48	9-Bit to 18-Bit HSTL-to-LVTTL Memory Address Latches	✓	SCES096
SN74HSTL16919	48	9-Bit to 18-Bit HSTL-to-LVTTL Memory Address Latches with Pullup Resistors	✓	SCES348
SN74HSTL162822	64	14-Bit to 28-Bit HSTL-to-LVTTL Memory Address Latches	✓	SCES091

### commercial package description and availability

#### DSBGA (die-size ball grid array)†

YEA, YZA = 5/6/8 pins  
YEP, YZP = 5/6/8 pins

#### LFBGA (low-profile fine-pitch ball grid array)

GGM = 80/100 pins  
GKE, ZKE = 96 pins  
GKF, ZKF = 114 pins

#### VFBGA (very-thin-profile fine-pitch ball grid array)

GQN, ZQN = 20 pins  
GQL, ZQL = 56 pins (also includes 48-pin functions)

#### schedule

✓ = Now    ✚ = Planned

#### PDIP (plastic dual-in-line package)

P = 8 pins  
N = 14/16/20/24 pins  
NT = 24/28 pins

#### PLCC (plastic leaded chip carrier)

FN = 20/28/44/68/84 pins

#### SOIC (small-outline integrated circuit)

D = 8/14/16 pins  
DW = 16/18/20/24/28 pins

#### SOT (small-outline transistor)

PK = 3 pins  
DBV = 3/4/5 pins  
DCY = 4 pins  
DCK = 5/6 pins

#### QFN (quad flatpack no lead)

RGY = 14/16/20 pins  
RGQ = 56 pins

#### QFP (quad flatpack)

RC = 52 pins (FB only)  
PH = 80 pins (FIFOs only)  
PQ = 100/132 pins (FIFOs only)

#### LQFP (low-profile quad flatpack)

PZA = 80 pins

#### TQFP (plastic thin quad flatpack)

PAH = 52 pins  
PAG = 64 pins (FB only)  
PM = 64 pins  
PN = 80 pins  
PCA, PZ = 100 pins (FB only)  
PCB = 120 pins (FIFOs only)

#### SOP (small-outline package)

PS = 8 pins  
NS = 14/16/20/24 pins

#### QSOP (quarter-size small-outline package)

DBQ = 16/20/24 pins

#### SSOP (shrink small-outline package)

DCT = 8 pins  
DB = 14/16/20/24/28/30/38 pins  
DBQ = 16/20/24 pins  
DL = 28/48/56 pins

#### TSSOP (thin shrink small-outline package)

PW = 8/14/16/20/24/28 pins  
DGG = 48/56/64 pins

#### TVSOP (thin very small-outline package)

DGV = 14/16/20/24/48/56 pins  
DBB = 80/100 pins

#### VSSOP (very thin shrink small-outline package)

DCU = 8 pins

† JEDEC reference for wafer chip scale package (WCSP)



## **SSTU**

### **Stub Series-Terminated Ultra-Low-Voltage Logic**

TI introduces the SN74SSTU32864, which prepares the industry for double-data-rate II (DDR-II) registered dual inline memory modules (RDIMMs). While competitors still are focusing on back filling their DDR-I portfolios, TI again takes the leadership role by being ahead of the market with this register, which is targeted at next-generation DDR-II systems. The SN74SSTU32864 is the world's first DDR-II register that employs output edge-control circuitry similar to the technology used in the successful SSTVF product line. The SN74SSTU32864 has proven simultaneous switching performance in initial prototype DDR-II RDIMMs, enabling high speeds without sacrificing signal integrity. This device is configurable as a 1:1 or 1:2 registered buffer, which makes it flexible enough to be used in a multitude of RDIMM configurations.

TI also offers the SN74SSTU32866 for higher-reliability systems. This register has the capability of adding parity to a DDR-II RDIMM. Additional parity I/Os are introduced for the parity calculation. When two devices are used on a DIMM, the register has the capability of cascading the parity path of the two registers while maintaining the same parity output timing as the single device parity configuration.

SSTU family features:

- Operation at 1.7 V to 1.9 V for PC2-3200 and PC2-4300
- Pinout optimizes DDR-II DIMM PCB layout.
- Chip-select inputs gate the data outputs from changing state and minimize system power consumption.
- Output edge-control circuitry minimizes switching noise in an unterminated line.
- Parity option available

TI provides the complete solution when the CDCU877 PLL clock driver is used. Please see the following table for the device that best fits your application:

<b>DIMM CONFIGURATION</b>	<b>PC2-3200/PC2-4300 DDR2-400/DDR2-533 LOW PROFILE (1U) NON PARITY</b>	<b>PC2-3200/PC2-4300 DDR2-400/DDR2-533 LOW PROFILE (1U) WITH PARITY CHECK</b>
Planar 1 rank of x8 SDRAMs 9 loads	SSTU32864 – 25-bit 1:1 configuration 96-ball LFBGA 1 per DIMM	SSTU32866 – 25-bit 1:1 configuration 96-ball LFBGA 1 per DIMM/uncascaded parity
Planar double-sided 2 rank of x8 SDRAMs 1 rank x4 SDRAMs 18 loads	SSTU32864 – 14-bit 1:2 configuration 96-ball LFBGA 2 per DIMM	SSTU32866 – 14-bit 1:2 configuration 96-ball LFBGA 2 per DIMM/uncascaded parity

DEVICE	NO. PINS	DESCRIPTION	AVAILABILITY	LITERATURE
			LFBGA	REFERENCE
SN74SSTU32864	96	25-Bit Configurable Registered Buffers with SSTL_18 Inputs and Outputs	✓	SCES434
SN74SSTU32866	96	25-Bit Configurable Registered Buffers with Address-Parity Test	✦	Call

**commercial package description and availability**

**DSBGA** (die-size ball grid array)†

YEA, YZA = 5/6/8 pins  
YEP, YZP = 5/6/8 pins

**LFBGA** (low-profile fine-pitch ball grid array)

GGM = 80/100 pins  
GKE, ZKE = 96 pins  
GKF, ZKF = 114 pins

**VFPGA** (very-thin-profile fine-pitch ball grid array)

GQN, ZQN = 20 pins  
GQL, ZQL = 56 pins (also includes 48-pin functions)

**schedule**

✓ = Now ✦ = Planned

† JEDEC reference for wafer chip scale package (WCSP)

**PDIP** (plastic dual-in-line package)

P = 8 pins  
N = 14/16/20/24 pins  
NT = 24/28 pins

**PLCC** (plastic leaded chip carrier)

FN = 20/28/44/68/84 pins

**SOIC** (small-outline integrated circuit)

D = 8/14/16 pins  
DW = 16/18/20/24/28 pins

**SOT** (small-outline transistor)

PK = 3 pins  
DBV = 3/4/5 pins  
DCY = 4 pins  
DCK = 5/6 pins

**QFN** (quad flatpack no lead)

RGY = 14/16/20 pins  
RGQ = 56 pins

**QFP** (quad flatpack)

RC = 52 pins (FB only)  
PH = 80 pins (FIFOs only)  
PQ = 100/132 pins (FIFOs only)

**LQFP** (low-profile quad flatpack)

PZA = 80 pins

**TQFP** (plastic thin quad flatpack)

PAH = 52 pins  
PAG = 64 pins (FB only)  
PM = 64 pins  
PN = 80 pins  
PCA, PZ = 100 pins (FB only)  
PCB = 120 pins (FIFOs only)

**SOP** (small-outline package)

PS = 8 pins  
NS = 14/16/20/24 pins

**QSOP** (quarter-size small-outline package)

DBQ = 16/20/24 pins

**SSOP** (shrink small-outline package)

DCT = 8 pins  
DB = 14/16/20/24/28/30/38 pins  
DBQ = 16/20/24 pins  
DL = 28/48/56 pins

**TSSOP** (thin shrink small-outline package)

PW = 8/14/16/20/24/28 pins  
DGG = 48/56/64 pins

**TVSOP** (thin very small-outline package)

DGV = 14/16/20/24/48/56 pins  
DBB = 80/100 pins

**VSSOP** (very thin shrink small-outline package)

DCU = 8 pins

## **SSTV/SSTVF**

### **Stub Series-Terminated Low-Voltage Logic**

The TI SSTV family is optimized for 2.5-V  $V_{CC}$  operation. The devices offered in this family are ideal solutions for address/control bus buffering in high-performance double-data-rate (DDR) memory systems. TI offers a variety of solutions for DDR registered dual inline memory module (RDIMM) applications. The SN74SSTV16857 is a 14-bit 1:1 register with low-power mode support designed for stacked DIMM applications. Two registers per DIMM are required when using these devices.

The SN74SSTV32852 combines the functionality of two SN74SSTV16859 devices to provide a cost-effective, single-chip solution for stacked applications. The SSTV family of devices is ideal for use in DDR200/266 applications. The SSTV family features SSTL\_2 class-II drivers, which are ideal for terminated buses often used in motherboard applications.

To meet the needs for DDR333/400 registered DIMMs, TI was the first to release their SSTVF product line. As a faster version of the SSTV family, SSTVF devices feature SSTL\_2 class-I outputs specifically designed for the unterminated DIMM load. This enables an increase in performance without sacrificing signal integrity. The result is a system with increased timing margins and better reliability. The SSTVF devices are available in all the popular SSTV functions used for planar and stacked DIMMs. All SSTVF devices are backward compatible with SSTV devices in registered DIMM applications. The CDCV857B differential clock complete the TI solution for DDR RDIMMs.

Please see the following table for the device that best fits your application:

<b>DIMM CONFIGURATION</b>	<b>PC1600/PC2100 DDR200/266 1.7" DIMM</b>	<b>PC1600/PC2100 DDR200/266 1U DIMM</b>	<b>PC2700 DDR333 1U DIMM</b>	<b>PC3200 DDR400 1U DIMM</b>
Planar 1 rank of x8 SDRAMs 9 loads	SSTV16857 – 14-bit 1:1 48-pin TSSOP 2 per DIMM	SSTV16857 – 14-bit 1:1 48-pin TSSOP 2 per DIMM	SSTVF16857 – 14-bit 1:1 48-pin TSSOP 2 per DIMM	SSTVF16859 – 13-bit 1:2 56-pin QFN 2 per DIMM
Planar double-sided 2 rank of x8 SDRAMs 18 loads	SSTV16857 – 14-bit 1:1 48-pin TSSOP 2 per DIMM	SSTV16857 – 14-bit 1:1 48-pin TSSOP 2 per DIMM	SSTVF16857 – 14-bit 1:1 48-pin TSSOP 2 per DIMM	SSTVF16859 – 13-bit 1:2 56-pin QFN 2 per DIMM
Stacked double-sided 2 rank of x4 SDRAMs 36 loads	SSTV16859 – 13-bit 1:2 64-pin TSSOP 2 per DIMM	SSTV32852 – 24-bit 1:2 114-ball LFBGA 1 per DIMM	SSTVF32852 – 24-bit 1:2 114-ball LFBGA 1 per DIMM	No solution
		SSTV16859 – 13-bit 1:2 56-pin QFN 2 per DIMM	SSTVF16859 – 13-bit 1:2 64-pin TSSOP/56-pin QFN 2 per DIMM	

**Migrate to SSTVF  
for better signal integrity  
and timing margins**

DEVICE	NO. PINS	DESCRIPTION	AVAILABILITY				LITERATURE REFERENCE
			LFBGA	QFN	TSSOP	TVSOP	
<b>SSTV</b>							
SN74SSTV16857	48	14-Bit Registered Buffers with SSTL_2 Inputs and Outputs			✓	✓	SCES344
SN74SSTV16859	56/64	13-Bit to 26-Bit Registered Buffers with SSTL_2 Inputs and Outputs		✓ (56)	✓ (64)		SCES297
SN74SSTV32852	114	24-Bit to 48-Bit Registered Buffers with SSTL_2 Inputs and Outputs	✓				SCES361
SN74SSTV32867	96	26-Bit Registered Buffers with SSTL_2 Inputs and LVCMOS Outputs	✓				SCES362
SN74SSTV32877	96	26-Bit Registered Buffers with SSTL_2 Inputs and Outputs	✓				SCES378
<b>SSTVF</b>							
SN74SSTVF16857	48	14-Bit Registered Buffers with SSTL_2 Inputs and Outputs			✓	✓	SCES411
SN74SSTVF16859	56/64	13-Bit to 26-Bit Registered Buffers with SSTL_2 Inputs and Outputs		✓ (56)	✓ (64)		SCES429
SN74SSTVF32852	114	24-Bit to 48-Bit Registered Buffers with SSTL_2 Inputs and Outputs	✓				SCES426

**commercial package description and availability**

**DSBGA** (die-size ball grid array)†

YEA, YZA = 5/6/8 pins  
YEP, YZP = 5/6/8 pins

**LFBGA** (low-profile fine-pitch ball grid array)

GGM = 80/100 pins  
GKE, ZKE = 96 pins  
GKF, ZKF = 114 pins

**VFPGA** (very-thin-profile fine-pitch ball grid array)

GQN, ZQN = 20 pins  
GQL, ZQL = 56 pins (also includes 48-pin functions)

**schedule**

✓ = Now ✦ = Planned

† JEDEC reference for wafer chip scale package (WCSP)

**PDIP** (plastic dual-in-line package)

P = 8 pins  
N = 14/16/20/24 pins  
NT = 24/28 pins

**PLCC** (plastic leaded chip carrier)

FN = 20/28/44/68/84 pins

**SOIC** (small-outline integrated circuit)

D = 8/14/16 pins  
DW = 16/18/20/24/28 pins

**SOT** (small-outline transistor)

PK = 3 pins  
DBV = 3/4/5 pins  
DCY = 4 pins  
DCK = 5/6 pins

**QFN** (quad flatpack no lead)

RGY = 14/16/20 pins  
RGQ = 56 pins

**QFP** (quad flatpack)

RC = 52 pins (FB only)  
PH = 80 pins (FIFOs only)  
PQ = 100/132 pins (FIFOs only)

**LQFP** (low-profile quad flatpack)

PZA = 80 pins

**TQFP** (plastic thin quad flatpack)

PAH = 52 pins  
PAG = 64 pins (FB only)  
PM = 64 pins  
PN = 80 pins  
PCA, PZ = 100 pins (FB only)  
PCB = 120 pins (FIFOs only)

**SOP** (small-outline package)

PS = 8 pins  
NS = 14/16/20/24 pins

**QSOP** (quarter-size small-outline package)

DBQ = 16/20/24 pins

**SSOP** (shrink small-outline package)

DCT = 8 pins  
DB = 14/16/20/24/28/30/38 pins  
DBQ = 16/20/24 pins  
DL = 28/48/56 pins

**TSSOP** (thin shrink small-outline package)

PW = 8/14/16/20/24/28 pins  
DGG = 48/56/64 pins

**TVSOP** (thin very small-outline package)

DGV = 14/16/20/24/48/56 pins  
DBB = 80/100 pins

**VSSOP** (very thin shrink small-outline package)

DCU = 8 pins



# **TTL**

## **Transistor-Transistor Logic**

With a wide array of functions, TI's TTL family continues to offer replacement alternatives for mature systems. This classic line of devices was at the cutting edge of performance when introduced, and it continues to deliver excellent value for many of today's designs. As the world leader in logic products, TI is committed to being the last major supplier at every price-performance node.

See [www.ti.com/sc/logic](http://www.ti.com/sc/logic) for the most current data sheets.

# DEVICE SELECTION GUIDE

## TTL

DEVICE	NO. PINS	DESCRIPTION	AVAILABILITY			LITERATURE REFERENCE
			MIL	PDIP	SOIC	
SN7400	14	Quad 2-Input NAND Gates	✓	✓	✓	SDLS025
SN7402	14	Quad 2-Input NOR Gates	✓	✓		SDLS027
SN7404	14	Hex Inverters	✓	✓	✓	SDLS029
SN7406	14	Hex Inverter Buffers/Drivers with Open-Collector Outputs	✓	✓	✓	SDLS031
SN7407	14	Hex Buffers/Drivers with Open-Collector Outputs	✓	✓	✓	SDLS032
SN7410	14	Triple 3-Input NAND Gates	✓	✓		SDLS035
SN7414	14	Hex Schmitt-Trigger Inverters	✓	✓	✓	SDLS049
SN7416	14	Hex Inverter Buffer/Drivers with Open-Collector Outputs	✓	✓	✓	SDLS031
SN7417	14	Hex Buffers/Drivers with Open-Collector Outputs	✓	✓	✓	SDLS032
SN7425	14	Dual 4-Input NOR Gates with Strobe	✓	✓		SDLS082
SN7432	14	Quad 2-Input OR Gates	✓	✓		SDLS100
SN7437	14	Quad 2-Input NAND Gates	✓	✓		SDLS103
SN7438	14	Quad 2-Input NAND Gates	✓	✓	✓	SDLS105
SN7445	16	BCD-to-Decimal Decoders/Drivers	✓	✓		SDLS110
SN7447A	16	BCD to 7-Segment Decoders/Drivers	✓	✓		SDLS111
SN7497	16	Synchronous 6-Bit Binary Rate Multipliers	✓	✓		SDLS130
SN74107	14	Dual Negative-Edge-Triggered J-K Flip-Flops with Reset	✓	✓		SDLS036
SN74121	14	Monostable Multivibrators with Schmitt-Trigger Inputs	✓	✓	✓	SDLS042
SN74123	16	Dual Retriggerable Monostable Multivibrators with Reset	✓	✓		SDLS043
SN74128	14	Hex OR-Gate Line Drivers	✓	✓	✓	SDLS045
SN74132	14	Quad 2-Input NAND Gates with Schmitt-Trigger Inputs	✓	✓		SDLS047
SN74145	16	BCD-to-Decimal Decoders/Drivers	✓	✓		SDLS051
SN74150	24	1-of-16 Data Selectors/Multiplexers	✓	✓		SDLS054
SN74154	24	4-to-16 Line Decoders/Demultiplexers	✓	✓		SDLS056
SN74159	24	4-to-16 Line Decoders/Demultiplexers with Open-Collector Outputs		✓		SDLS059
SN74175	16	Quad D-Type Flip-Flops with Clear	✓	✓		SDLS068
SN74193	16	Presetable Synchronous 4-Bit Up/Down Binary Counters	✓	✓		SDLS074
SN74221	16	Dual Monostable Multivibrators with Schmitt-Trigger Inputs	✓	✓		SDLS213
SN74276	20	Quad J-K̄ Flip-Flops		✓	✓	SDLS091
SN74367A	16	Hex Buffers/Line Drivers with 3-State Outputs	✓	✓		SDLS102
SN74368A	16	Hex Inverting Buffers/Line Drivers with 3-State Outputs	✓	✓		SDLS102
SN74393	14	Dual 4-Bit Binary Counters	✓	✓		SDLS107

### commercial package description and availability

#### DSBGA (die-size ball grid array)†

YEA, YZA = 5/6/8 pins  
YEP, YZP = 5/6/8 pins

#### LFBGA (low-profile fine-pitch ball grid array)

GGM = 80/100 pins  
GKE, ZKE = 96 pins  
GKF, ZKF = 114 pins

#### VFBGA (very-thin-profile fine-pitch ball grid array)

GQN, ZQN = 20 pins  
GQL, ZQL = 56 pins (also includes 48-pin functions)

#### schedule

✓ = Now    ✚ = Planned

#### PDIP (plastic dual-in-line package)

P = 8 pins  
N = 14/16/20/24 pins  
NT = 24/28 pins

#### PLCC (plastic leaded chip carrier)

FN = 20/28/44/68/84 pins

#### SOIC (small-outline integrated circuit)

D = 8/14/16 pins  
DW = 16/18/20/24/28 pins

#### SOT (small-outline transistor)

PK = 3 pins  
DBV = 3/4/5 pins  
DCY = 4 pins  
DCK = 5/6 pins

#### QFN (quad flatpack no lead)

RGY = 14/16/20 pins  
RGQ = 56 pins

#### QFP (quad flatpack)

RC = 52 pins (FB only)  
PH = 80 pins (FIFOs only)  
PQ = 100/132 pins (FIFOs only)

#### LQFP (low-profile quad flatpack)

PZA = 80 pins

#### TQFP (plastic thin quad flatpack)

PAH = 52 pins  
PAG = 64 pins (FB only)  
PM = 64 pins  
PN = 80 pins  
PCA, PZ = 100 pins (FB only)  
PCB = 120 pins (FIFOs only)

#### SOP (small-outline package)

PS = 8 pins  
NS = 14/16/20/24 pins

#### QSOP (quarter-size small-outline package)

DBQ = 16/20/24 pins

#### SSOP (shrink small-outline package)

DCT = 8 pins  
DB = 14/16/20/24/28/30/38 pins  
DBQ = 16/20/24 pins  
DL = 28/48/56 pins

#### TSSOP (thin shrink small-outline package)

PW = 8/14/16/20/24/28 pins  
DGG = 48/56/64 pins

#### TVSOP (thin very small-outline package)

DGV = 14/16/20/24/48/56 pins  
DBB = 80/100 pins

#### VSSOP (very thin shrink small-outline package)

DCU = 8 pins

† JEDEC reference for wafer chip scale package (WCSP)



# TVC

## Translation Voltage Clamp Logic

TVC products are designed to protect components sensitive to high-state voltage-level overshoots.

New designs for PCs and other bus-oriented products require faster and lower-power devices built with advanced submicron semiconductor processes. Often, the I/Os of these devices are intolerant of high-state voltage levels on the communication buses used. The need for I/O protection became apparent for devices communicating with legacy buses, and the TVC family fills this need.

TVC devices offer an array of n-type metal-oxide semiconductor (NMOS) field-effect transistors (FETs), with the gates cascaded to a common gate input. TVC devices can be used as voltage limiters by connecting one of the FETs as a voltage reference transistor and the remainder as pass transistors. The low-voltage side of each pass transistor is limited to the voltage set by the reference transistor. All of the FETs in the array have essentially the same characteristics, so any one can be used as the reference transistor. Because the fabrication of the FETs is symmetrical, either port connection for each bit can be used as the low-voltage side, and the I/O signals are bidirectional through each FET.

Key features:

- No logic supply voltage required (no internal control logic)
- Used as voltage translators or voltage clamps
- 7- $\Omega$  on-state resistance with gate at 3.3 V
- Any FET can be used as the reference transistor.
- Direct interface with GTL+ levels
- Accept any I/O voltage from 0 to 5.5 V
- Flow-through pinout for ease of printed circuit board layout
- Minimum fabrication process transistor characteristic variations

See [www.ti.com/sc/logic](http://www.ti.com/sc/logic) for the most current data sheets.

# DEVICE SELECTION GUIDE

## TVC

DEVICE	NO. PINS	FUNCTION	AVAILABILITY						LITERATURE REFERENCE
			QSOP	SOIC	SOT	SSOP	TSSOP	TVSOP	
SN74TVC3010	24	10-Bit Translation Voltage Clamps	✓	✓			✓	✓	SCDS088
SN74TVC3306	8	Dual Voltage Clamps			✓			✓	SCDS112
SN74TVC16222A	48	22-Bit Translation Voltage Clamps				✓	✓	✓	SCDS087

### commercial package description and availability

#### DSBGA (die-size ball grid array)†

YEA, YZA = 5/6/8 pins  
YEP, YZP = 5/6/8 pins

#### LFBGA (low-profile fine-pitch ball grid array)

GGM = 80/100 pins  
GKE, ZKE = 96 pins  
GKF, ZKF = 114 pins

#### VFBGA (very-thin-profile fine-pitch ball grid array)

GQN, ZQN = 20 pins  
GQL, ZQL = 56 pins (also includes 48-pin functions)

#### schedule

✓ = Now   ✚ = Planned

† JEDEC reference for wafer chip scale package (WCSP)

#### PDIP (plastic dual-in-line package)

P = 8 pins  
N = 14/16/20/24 pins  
NT = 24/28 pins

#### PLCC (plastic leaded chip carrier)

FN = 20/28/44/68/84 pins

#### SOIC (small-outline integrated circuit)

D = 8/14/16 pins  
DW = 16/18/20/24/28 pins

#### SOT (small-outline transistor)

PK = 3 pins  
DBV = 3/4/5 pins  
DCY = 4 pins  
DCK = 5/6 pins

#### QFN (quad flatpack no lead)

RGY = 14/16/20 pins  
RGQ = 56 pins

#### QFP (quad flatpack)

RC = 52 pins (FB only)  
PH = 80 pins (FIFOs only)  
PQ = 100/132 pins (FIFOs only)

#### LQFP (low-profile quad flatpack)

PZA = 80 pins

#### TQFP (plastic thin quad flatpack)

PAH = 52 pins  
PAG = 64 pins (FB only)  
PM = 64 pins  
PN = 80 pins  
PCA, PZ = 100 pins (FB only)  
PCB = 120 pins (FIFOs only)

#### SOP (small-outline package)

PS = 8 pins  
NS = 14/16/20/24 pins

#### QSOP (quarter-size small-outline package)

DBQ = 16/20/24 pins

#### SSOP (shrink small-outline package)

DCT = 8 pins  
DB = 14/16/20/24/28/30/38 pins  
DBQ = 16/20/24 pins  
DL = 28/48/56 pins

#### TSSOP (thin shrink small-outline package)

PW = 8/14/16/20/24/28 pins  
DGG = 48/56/64 pins

#### TVSOP (thin very small-outline package)

DGV = 14/16/20/24/48/56 pins  
DBB = 80/100 pins

#### VSSOP (very thin shrink small-outline package)

DCU = 8 pins



## **VME**

### **VERSAmodule Eurocard Bus Technology**

TI introduces the SN74VMEH22501, which is specifically designed for VMEbus technology. The device is an 8-bit universal bus transceiver with two bus transceivers. The device provides incident-wave switching on the standard 21-slot VMEbus backplane, thus, producing data signaling rates of up to 40 Mbps – an 8× improvement over the VME64 standard.

SN74VMEH22501 features:

- Ability to transmit data on the VMEbus up to two-edge source synchronous transfer (2eSST) protocol speeds – an 8× improvement over the VME64 standard
- Incident-wave switching allows higher performance on the VMEbus, compared to conventional logic that depends on reflective wave switching.
- Backward compatibility to legacy VMEbus backplane

Target applications:

- Industrial controls
- Telecommunications
- Instrumentation systems

See [www.ti.com/sc/logic](http://www.ti.com/sc/logic) for the most current data sheets.

# DEVICE SELECTION GUIDE

## VME

DEVICE	NO. PINS	FUNCTION	AVAILABILITY			LITERATURE REFERENCE
			TSSOP	TVSOP	VFBGA	
SN74VMEH22501	48/56	8-Bit Universal Bus Transceivers and Two 1-Bit Bus Transceivers with 3-State Outputs	✓	✓	✓	SCES357

### commercial package description and availability

#### DSBGA (die-size ball grid array)†

YEA, YZA = 5/6/8 pins  
YEP, YZP = 5/6/8 pins

#### LFBGA (low-profile fine-pitch ball grid array)

GGM = 80/100 pins  
GKE, ZKE = 96 pins  
GKF, ZKF = 114 pins

#### VFBGA (very-thin-profile fine-pitch ball grid array)

GQN, ZQN = 20 pins  
GQL, ZQL = 56 pins (also includes 48-pin functions)

#### schedule

✓ = Now    ✚ = Planned

† JEDEC reference for wafer chip scale package (WCSP)

#### PDIP (plastic dual-in-line package)

P = 8 pins  
N = 14/16/20/24 pins  
NT = 24/28 pins

#### PLCC (plastic leaded chip carrier)

FN = 20/28/44/68/84 pins

#### SOIC (small-outline integrated circuit)

D = 8/14/16 pins  
DW = 16/18/20/24/28 pins

#### SOT (small-outline transistor)

PK = 3 pins  
DBV = 3/4/5 pins  
DCY = 4 pins  
DCK = 5/6 pins

#### QFN (quad flatpack no lead)

RGY = 14/16/20 pins  
RGQ = 56 pins

#### QFP (quad flatpack)

RC = 52 pins (FB only)  
PH = 80 pins (FIFOs only)  
PQ = 100/132 pins (FIFOs only)

#### LQFP (low-profile quad flatpack)

PZA = 80 pins

#### TQFP (plastic thin quad flatpack)

PAH = 52 pins  
PAG = 64 pins (FB only)  
PM = 64 pins  
PN = 80 pins  
PCA, PZ = 100 pins (FB only)  
PCB = 120 pins (FIFOs only)

#### SOP (small-outline package)

PS = 8 pins  
NS = 14/16/20/24 pins

#### QSOP (quarter-size small-outline package)

DBQ = 16/20/24 pins

#### SSOP (shrink small-outline package)

DCT = 8 pins  
DB = 14/16/20/24/28/30/38 pins  
DBQ = 16/20/24 pins  
DL = 28/48/56 pins

#### TSSOP (thin shrink small-outline package)

PW = 8/14/16/20/24/28 pins  
DGG = 48/56/64 pins

#### TVSOP (thin very small-outline package)

DGV = 14/16/20/24/48/56 pins  
DBB = 80/100 pins

#### VSSOP (very thin shrink small-outline package)

DCU = 8 pins



<b>LOGIC OVERVIEW</b>	<b>1</b>
<b>FOCUS ON NAVIGATING THE TI LOGIC WEB</b>	<b>2</b>
<b>FUNCTIONAL INDEX</b>	<b>3</b>
<b>FUNCTIONAL CROSS-REFERENCE</b>	<b>4</b>
<b>DEVICE SELECTION GUIDE</b>	<b>5</b>
<b>PACKAGING AND MARKING INFORMATION</b>	<b>A</b>
<b>LOGIC PURCHASING TOOL/ALTERNATE SOURCES</b>	<b>B</b>

**PACKAGING AND MARKING INFORMATION**

**A**



# APPENDIX A

## PACKAGING AND MARKING INFORMATION

---

### CONTENTS

Device Names and Package Designators for TI Logic Products .....	A-5
Device Names and Package Designators for Logic Products Formerly Offered by Cypress Semiconductor .....	A-6
Device Names and Package Designators for Logic Products Formerly Offered by Harris Semiconductor .....	A-7
Logic Marking Guidelines .....	A-9
Moisture Sensitivity by Package .....	A-16
Packaging Cross-Reference .....	A-18

# DEVICE NAMES AND PACKAGE DESIGNATORS FOR TI LOGIC PRODUCTS

**Example:**

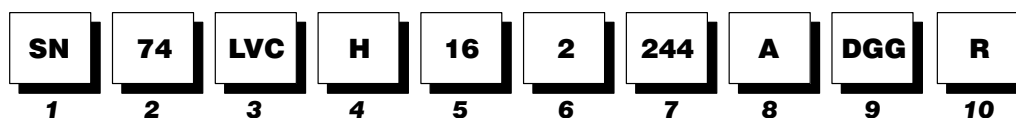

## 1 Standard Prefix

Examples: SN – Standard Prefix  
SNJ – Conforms to MIL-PRF-38535 (QML)

## 2 Temperature Range

Examples: 54 – Military  
74 – Commercial

## 3 Family

Examples: Blank = Transistor-Transistor Logic (TTL)  
ABT – Advanced BiCMOS Technology  
ABTE/ETL – Advanced BiCMOS Technology/  
Enhanced Transceiver Logic  
AC/ACT – Advanced CMOS Logic  
AHC/AHCT – Advanced High-Speed CMOS Logic  
ALB – Advanced Low-Voltage BiCMOS  
ALS – Advanced Low-Power Schottky Logic  
ALVC – Advanced Low-Voltage CMOS Technology  
ALVT – Advanced Low-Voltage BiCMOS Technology  
AS – Advanced Schottky Logic  
AUC – Advanced Ultra Low-Voltage CMOS Logic  
AVC – Advanced Very Low-Voltage CMOS Logic  
BCT – BiCMOS Bus-Interface Technology  
CB3Q – Low-Voltage High-Bandwidth Bus-Switch  
Crossbar Technology Logic  
CB3T – Low-Voltage Translator Bus-Switch  
Crossbar Technology Logic  
CBT – Crossbar Technology  
CBTLV – Low-Voltage Crossbar Technology  
CD4000 – CMOS B-Series Integrated Circuits  
F – F Logic  
FB – Backplane Transceiver Logic/Futurebus+  
FCT – Fast CMOS TTL Logic  
GTL – Gunning Transceiver Logic  
GTLP – Gunning Transceiver Logic Plus  
HC/HCT – High-Speed CMOS Logic  
HSTL – High-Speed Transceiver Logic  
LS – Low-Power Schottky Logic  
LV – Low-Voltage CMOS Technology  
LVC – Low-Voltage CMOS Technology  
LVT – Low-Voltage BiCMOS Technology  
PCA/PCF – I<sup>2</sup>C Inter-Integrated Circuit Applications  
S – Schottky Logic  
SSTL – Stub Series-Terminated Logic  
SSTU – Stub Series-Terminated  
Ultra-Low-Voltage Logic  
SSTV/SSTVF – Stub Series-Terminated  
Low-Voltage Logic  
TVC – Translation Voltage Clamp Logic  
VME – VERSAmodule Eurocard Bus Technology

## 4 Special Features

Examples: Blank = No Special Features  
C – Configurable V<sub>CC</sub> (LVCC)  
D – Level-Shifting Diode (CBTD)  
H – Bus Hold (ALVCH)  
K – Undershoot-Protection Circuitry (CBTK)  
R – Damping Resistor on Inputs/Outputs (LVCR)  
S – Schottky Clamping Diode (CBTS)  
Z – Power-Up 3-State (LVCZ)

## 5 Bit Width

Examples: Blank = Gates, MSI, and Octals  
1G – Single Gate  
2G – Dual Gate  
3G – Triple Gate  
8 – Octal IEEE 1149.1 (JTAG)  
16 – Widebus™ (16, 18, and 20 bit)  
18 – Widebus IEEE 1149.1 (JTAG)  
32 – Widebus+™ (32 and 36 bit)

## 6 Options

Examples: Blank = No Options  
2 – Series Damping Resistor on Outputs  
4 – Level Shifter  
25 – 25-Ω Line Driver

## 7 Function

Examples: 244 – Noninverting Buffer/Driver  
374 – D-Type Flip-Flop  
573 – D-Type Transparent Latch  
640 – Inverting Transceiver

## 8 Device Revision

Examples: Blank = No Revision  
Letter Designator A–Z

## 9 Packages

Commercial: D, DW – Small-Outline Integrated Circuit (SOIC)  
DB, DBQ, DCT, DL – Shrink Small-Outline Package (SSOP)  
DBB, DGV – Thin Very Small-Outline Package (TVSOP)  
DBQ – Quarter-Size Small-Outline Package (QSOP)  
DBV, DCK, DCY, PK – Small-Outline Transistor (SOT)  
DCU – Very Thin Shrink Small-Outline Package (VSSOP)  
DGG, PW – Thin Shrink Small-Outline Package (TSSOP)  
FN – Plastic Leaded Chip Carrier (PLCC)  
GGM, GKE, GKF, ZKE, ZKF – MicroStar BGA™  
Low-Profile Fine-Pitch Ball Grid Array (LFBGA)  
GQL, GQN, ZQL, ZQN – MicroStar Jr.™  
Very-Thin-Profile Fine-Pitch Ball Grid Array (VFBGA)  
N, NT, P – Plastic Dual-In-Line Package (PDIP)  
NS, PS – Small-Outline Package (SOP)  
PAG, PAH, PCA, PCB, PM, PN, PZ – Thin Quad Flatpack (TQFP)  
PH, PQ, RC – Quad Flatpack (QFP)  
PZA – Low-Profile Quad Flatpack (LQFP)  
RGQ, RGY – Quad Flatpack No Lead (QFN)  
YEA, YEP, YZA, YZP – NanoStar™ and NanoFree™  
Die-Size Ball Grid Array (DSBGA†)

Military: FK – Leadless Ceramic Chip Carrier (LCCC)  
GB – Ceramic Pin Grid Array (CPGA)  
HFP, HS, HT, HV – Ceramic Quad Flatpack (CQFP)  
J, JT – Ceramic Dual-In-Line Package (CDIP)  
W, WA, WD – Ceramic Flatpack (CFP)

## 10 Tape and Reel

Devices in the DB and PW package types include the R designation for reeled product. Existing product inventory designated LE may remain, but all products are being converted to the R designation.

Examples: Old Nomenclature – SN74LVTxxxDBLE  
New Nomenclature – SN74LVTxxxADBR  
R – Standard (valid for all surface-mount packages)  
T – Small Quantity Reels (available in Little Logic only)

There is no functional difference between LE and R designated products, with respect to the carrier tape, cover tape, or reels used.

† DSBGA is the JEDEC reference for wafer chip scale package (WCSP).

# DEVICE NAMES AND PACKAGE DESIGNATORS FOR LOGIC PRODUCTS FORMERLY OFFERED BY CYPRESS SEMICONDUCTOR

## CYFCT Nomenclature

### Example:

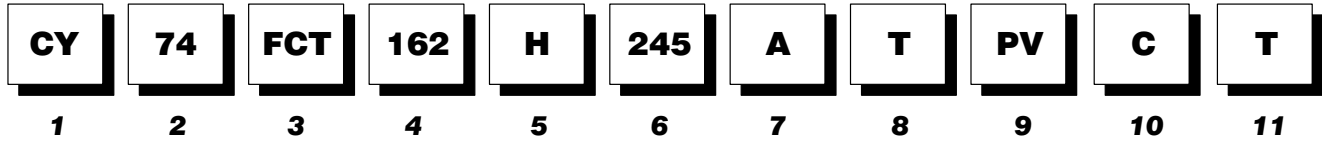

### 1 Prefix Designation for Acquired Cypress FCT Logic

May be blank to accommodate 18-character limitation

### 2 Temperature Range

Examples: 54 – Military (–55°C to 125°C)  
74 – Commercial/Industrial (–40°C to 85°C)  
29 – Commercial/Industrial or Military (see data sheet)

### 3 Family

Example: FCT – FAST™ CMOS TTL Logic

### 4 16 or Greater Bit Width With Balanced Drive or 3.3-V Operation

Examples: Blank  
16x – 16 or Greater Bit Width  
With Balanced Drive or 3.3-V Operation  
162 – Balanced Drive (series output resistors)  
163 – 3.3 V

### 5 Bus Hold

Examples: Blank = No Bus Hold  
H – Bus Hold (present only when preceded by 16x  
– see item 4)

### 6 Type Designation

Up to Five Digits  
Examples: 245  
1652  
16245

### 7 Speed Grade

Examples: Blank = No Speed Grade  
A  
B  
C  
D  
E

### 8 TTL or CMOS Outputs

Examples: Blank = CMOS Outputs  
T – TTL Outputs

### 9 Packages

Examples: P – Plastic Dual-In-Line Package (PDIP) (N)  
PA – Thin Shrink Small-Outline Package (TSSOP)  
(DGG/G)  
PV – Shrink Small-Outline Package (SSOP) (DL)  
Q – Quarter-Size Outline Package (QSOP) (DBQ)  
SO – Small-Outline Integrated Circuit (SOIC) (DL)

### 10 Processing

Example: C – Commercial Processing

### 11 Tape and Reel

Example: T – Tape-and-Reel Packing

# DEVICE NAMES AND PACKAGE DESIGNATORS FOR LOGIC PRODUCTS FORMERLY OFFERED BY HARRIS SEMICONDUCTOR

## CD4000 Nomenclature

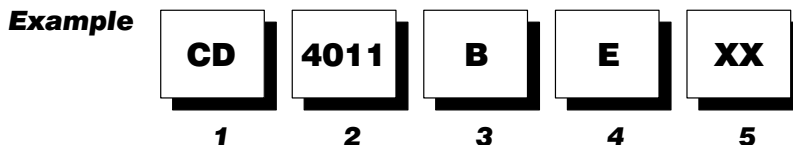

**1 Prefix Designation  
for Acquired Harris Digital Logic**

**2 Type Designation**

Up to Five Digits

**3 Supply Voltage**

Examples: A – 12 V Maximum  
B – 18 V Maximum  
UB – 18 V Maximum, Unbuffered

**4 Packages**

Examples: D – Ceramic Side-Brazed Dual-In-Line Package (DIP)  
E – Plastic DIP  
F – Ceramic DIP  
K – Ceramic Flatpack  
M – Plastic Surface-Mount  
Small-Outline Integrated Circuit (SOIC)  
SM – Plastic Shrink SOIC (SSOP)  
M96 – Reeled Plastic Surface-Mount SOIC  
SM96 – Reeled Plastic Shrink SOIC (SSOP)

**5 High-Reliability Screening**

Military Products Only

Examples: 3 – Noncompliant With MIL-STD-883, Class B  
3A – Fully Compliant With MIL-STD-883, Class B

## CDAC/CDACT Advanced CMOS and CDHC/CDHCT/CDHCU High-Speed CMOS Nomenclature

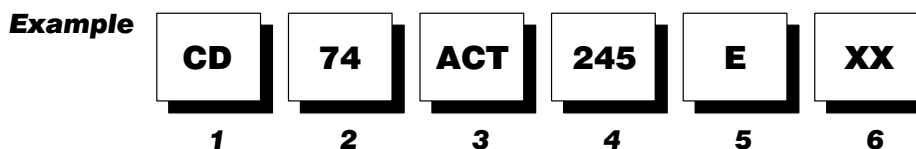

**1 Prefix Designation  
for Acquired Harris Digital Logic**

**2 Temperature Range**

Examples: 54 – Military (–55°C to 125°C)  
74 – Commercial (0°C to 70°C)

**3 Family**

Examples: AC – Advanced CMOS Logic, CMOS Input Levels  
ACT – Advanced CMOS Logic, TTL Input Levels  
HC – High-Speed CMOS Logic, CMOS Input Levels  
HCT – High-Speed CMOS Logic, TTL Input Levels  
HCU – High-Speed CMOS Logic, CMOS Input Levels, Unbuffered

**4 Type Designation**

Up to Five Digits

**5 Packages**

Examples: E – Plastic Dual-In-Line Package (DIP)  
EN – Plastic Slim-Line 24-Lead DIP  
F – Ceramic DIP  
M – Plastic Surface-Mount  
Small-Outline Integrated Circuit (SOIC)  
SM – Plastic Shrink SOIC (SSOP)  
M96 – Reeled Plastic Surface-Mount SOIC  
SM96 – Reeled Plastic Shrink SOIC (SSOP)

**6 High-Reliability Screening**

Military Products Only

Example: 3A – Fully Compliant With MIL-STD-883

# DEVICE NAMES AND PACKAGE DESIGNATORS FOR LOGIC PRODUCTS FORMERLY OFFERED BY HARRIS SEMICONDUCTOR

---

## CDFCT Nomenclature

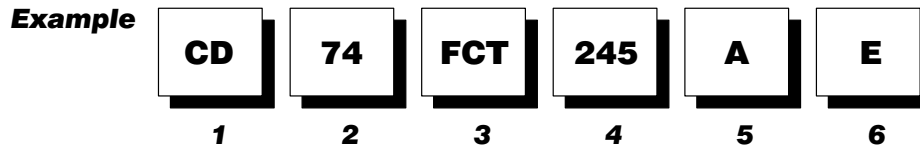

**1 Prefix Designation  
for Acquired Harris Digital Logic**

**2 Temperature Range**

Examples: 54 – Military (–55°C to 125°C)  
74 – Commercial (0°C to 70°C)

**3 Family**

Example: FCT – Bus Interface, TTL Input Levels

**4 Type Designation**

Up to Five Digits

**5 Speed Grade**

Example: Blank or A – Standard Equivalent to FAST™

**6 Packages**

Examples: E – Plastic Dual-In-Line Package (DIP)  
EN – Plastic Slim-Line 24-Lead DIP  
F – Ceramic DIP  
M – Plastic Surface-Mount  
Small-Outline Integrated Circuit (SOIC)  
SM – Plastic Shrink SOIC (SSOP)  
M96 – Reeled Plastic Surface-Mount SOIC  
SM96 – Reeled Plastic Shrink SOIC (SSOP)

## LOGIC MARKING GUIDELINES

---

In the past, logic products had the complete device name on the package. It has become necessary to reduce the character count, as package types have become smaller and logic names longer. Information in the following tables is intended to help interpret TI's logic symbolization.

Table A-1 defines a "name rule" (A, B, or C) based on the type of package for a specific device. Each name rule differs in the number of characters that are symbolized on the package. Name rule A uses the complete, or fully qualified, device name. Name rules B and C include fewer characters, respectively. Table A-2 is a listing of the various logic products by name rule.

**Example:** Assume a 48-pin TVSOP with the symbolization VH<sup>\*\*\*</sup>. Locate the 48-pin TVSOP (DGV) package in Table A-1, and find the name rule used (C). Proceed to Table A-2, and find VH<sup>\*\*\*</sup> in the *Name Rule C* column. The most complete device number, SN74ALVCH16<sup>\*\*\*</sup>, is located in the *Name Rule A* column.

See the following information and Tables A-3 and A-4 for Little Logic (PicoGate Logic, Microgate Logic, and NanoStar<sup>™</sup>) packages.

## LOGIC MARKING GUIDELINES

**Table A-1. Name-Rule Decision Tree**

PACKAGE	NO. PINS	NAME RULE	PACKAGE DESIGNATOR
LFBGA	96	C	GKE
	114	C	GKF
PDIP	8	A	P
	14, 16, 20	A	N
	24, 28	A	NP, NT
PLCC	28	A	FN
	44	B	FN
	68	A	FN
QSOP	16, 20, 24	B	DBQ
SOIC	8	C	D
	14, 16	B	D
	16, 20, 24, 28	B	DW
QFN	14, 16, 20	C	RGY
	56	C	RGQ
QFP	52	B	RC
	80	A	PH
	100, 132	A	PQ
SOP	8	C	PS
	14, 16, 20, 24	B	NS
SSOP	14, 16, 20, 24, 28, 30, 38	C	DB
	16, 20, 24	B	DBQ
	28, 48, 56	B	DL
TSSOP	8, 14, 16, 20, 24, 28	C	PW
	48, 56, 64	B	DGG
TVSOP	14, 16, 20, 24, 48, 56	C	DGV
	80	B	DBB
TQFP	52	B	PAH
	64	B	PAG, PM
	80	B	PN
	100	B	PZ, PCA
	120	B	PCB
VFBGA	56	C	GQL

## LOGIC MARKING GUIDELINES

**Table A-2. Typical Logic Package Symbolization Guidelines**

NAME RULE A	NAME RULE B	NAME RULE C
74AC***	AC***	AC***
74AC11***	AC11***	AE***
74ACT***	ACT***	AD***
74ACT1***	ACT1***	AU***
74ACT11***	ACT11***	AT***
CD4***	CD4***	CM***
CD4***	CD4***M†	CM***
CD74AC***	AC***M	HL***
CD74AC40	AC40***M	HY***
CD74ACT***	ACT***M	HM***
CD74ACT40***	ACT40***M	HZ***
CD74FCT***	74FCT***M	FC***
CD74FCT***	74FCT***M	FCT***SM‡
CD74HC***	HC***M	HJ***
CD74HC40***	HC40***M	HP***
CD74HCT***	HCT***M	HK***
CD74HCT40***	HCT40***M	HR***
CY29FCT***	29FCT***	FY***-§
CY74FCT***	FCT***	FT***-§
CY74FCT16***	FCT16***	FD***§
CY74FCT2***	FCT2***	FR***-§
PCF8***	PCF8***	PF***
SN64BCT***	DCT***	DT***
SN64BCT2***	DCT2***	DA***
SN64BCT25***	DCT25***	DC***
SN64BCT29***	DCT29***	DD***
SN74ABT***	ABT***	AB***
SN74ABT***-S	ABT***-S	AB***-S
SN74ABT16***	ABT16***	AH***
SN74ABT162***	ABT162***	AH2***
SN74ABT18***	ABT18***	AJ***
SN74ABT2***	ABT2***	AA***
SN74ABT5***	ABT5***	AF***
SN74ABT8***	ABT8***	AG***
SN74ABTE16***	ABTE16***	AN***
SN74ABTH***	ABTH***	AK***
SN74ABTH16***	ABTH16***	AM***
SN74ABTH162***	ABTH162***	AM2***
SN74ABTH18***	ABTH18***	AL***
SN74ABTR2***	ABTR2***	AR***
SN74AHC***	AHC***	HA***

† For SOIC D and DW packages only

‡ For DB package only

§ Speedcode

¶ For NS package only

NAME RULE A	NAME RULE B	NAME RULE C
SN74AHC16***	AHC16***	HE***
SN74AHCH16***	AHCH16***	HH***
SN74AHCT***	AHCT***	HB***
SN74AHCT16***	AHCT16***	HF***
SN74AHCTH16***	AHCTH16***	HG***
SN74AHCU***	AHCU***	HD***
SN74ALB16***	ALB16***	AV***
SN74ALS***	ALS***	G***
SN74ALVC***	ALVC***	VA***
SN74ALVC16***	ALVC16***	VC***
SN74ALVC162***	ALVC162***	VC2***
SN74ALVCH***	ALVCH***	VB***
SN74ALVCH16***	ALVCH16***	VH***
SN74ALVCH162***	ALVCH162***	VH2***
SN74ALVCH32***	ALVCH32***	ACH***
SN74ALVCHG16***	ALVCHG16***	VG***
SN74ALVCHG162***	ALVCHG162***	VG2***
SN74ALVCHR16***	ALVCHR16***	VR***
SN74ALVCHR162***	ALVCHR162***	VR2***
SN74ALVCHS162***	ALVCHS162***	VS2***
SN74ALVTH16***	ALVTH16***	VT***
SN74ALVTH162***	ALVTH162***	VT2***
SN74ALVTH32***	ALVTH32***	VL***
SN74AS***	AS***	AS***
SN74AS***	74AS***¶	AS***
SN74AVC***	AVC***	AVC***
SN74AVC16***	AVC16***	CVA***
SN74AVC32***	AVC32***	ACV***
SN74AVCC16***	AVCC16***	AW***
SN74AVCH16***	AVCH16***	CVH***
SN74BCT***	BCT***	BT***
SN74BCT11***	BCT11***	BB***
SN74BCT2***	BCT2***	BA***
SN74BCT25***	BCT25***	BC***
SN74BCT29***	BCT29***	BD***
SN74BCT8***	BCT8***	BG***
SN74CBT***	CBT***	CT***
SN74CBT16***	CBT16***	CY***
SN74CBT3***	CBT3***	CU***
SN74CBT6***	CBT6***	CT6***
SN74CBTD***	CBTD***	CD***



## LOGIC MARKING GUIDELINES

**Table A-2. Typical Logic Package Symbolization Guidelines (continued)**

NAME RULE A	NAME RULE B	NAME RULE C
SN74CBTD16***	CBTD16***	CYD***
SN74CBTD3***	CBTD3***	CC***
SN74CBTH16***	CBTH16***	CYH***
SN74CBTK***	CBTK***	BK***
SN74CBTK16***	CBTK16***	CP***
SN74CBTK32***	CBTK32***	KT***
SN74CBTLV16***	CBTLV16***	CN***
SN74CBTLV3***	CBTLV3***	CL***
SN74CBTR16***	CBTR16***	CZ***
SN74CBTS***	CBTS***	CS***
SN74CBTS16***	CBTS16***	CYS***
SN74CBTS3***	CBTS3***	CR***
SN74F***	F***	F***
SN74F***	74F***†	F***
SN74GTLV***	GTLV***	GT***
SN74GTLV16***	GTLV16***	GP***
SN74GTLPH***	GTLPH***	GH***
SN74GTLPH16***	GTLPH16***	GL***
SN74GTLPH32***	GTLPH32***	GM***
SN74HC***	HC***	HC***
SN74HCT***	HCT***	HT***
SN74HCU***	HCU***	HU***
SN74LS***	LS***	LS***
SN74LS***	74LS***†	LS***
SN74LV***	LV***	LV***
SN74LV***	74LV***†	LV***
SN74LVC***	LVC***	LC***
SN74LVC16***	LVC16***	LD***
SN74LVC2***	LVC2***	LE***
SN74LVC32***	LVC32***	NC***
SN74LVC4***	LVC4***	LJ***
SN74LVC8***	LVC8***	LC8***

NAME RULE A	NAME RULE B	NAME RULE C
SN74LVCC3***	LVCC3***	LH***
SN74LVCC4***	LVCC4***	LG***
SN74LVCH***	LVCH***	LCH***
SN74LVCH16***	LVCH16***	LDH***
SN74LVCH162***	LVCH162***	LN2***
SN74LVCH32***	LVCH32***	CH***
SN74LVCHR162***	LVCHR162***	LR2***
SN74LVCR2***	LVCR2***	LER***
SN74LVCU***	LVCU***	LCU***
SN74LVZ***	LVZ***	CV***
SN74LVZ16***	LVZ16***	CW***
SN74LVT***	LVT***	LX***
SN74LVT***-S	LVT***-S	LX***-S
SN74LVT162***	LVT162***	LZ***
SN74LVT18***	LVT18***	T18***
SN74LVT2***	LVT2***	LY***
SN74LVT32***	LVT32***	VJ***
SN74LVTH***	LVTH***	LXH***
SN74LVTH16***	LVTH16***	LL***
SN74LVTH162***	LVTH162***	LL2***
SN74LVTH2***	LVTH2***	LK***
SN74LVTH32***	LVTH32***	HV***
SN74LVTR***	LVTR***	LXR***
SN74LVTT***	LVTT***	LXT***
SN74LVTZ***	LVTZ***	LXZ***
SN74LVU***	LVU***	LU***
SN74S***	S***	S***
SN74S***	74S***†	S***
SN74SSTV16***	SSTV16***	SS***
SN74TVC16***	TVC16***	TW***
SN74TVC3***	TVC3***	TT***

† For SOIC D and DW packages only

‡ For DB package only

§ Speedcode

¶ For NS package only

### Little Logic Packages

TI Little Logic devices are available in several small pin-count package options. Leadframe devices are offered in 5-pin SOT-23 (DBV), 5-pin SC-70 (DCK), 6-pin SOT-23 (DBV), 6-pin SC-70 (DCK), 8-pin SM-8 (DCT), and 8-pin US-8 (DCU). Wafer chip scale packaging (WCSP) is available with TI NanoStar™ (YEA) and NanoFree™ (YZA) packages in 5-, 6-, and 8-ball solder bump configurations.

Tables A-3 and A-4 list the possible device technology and function codes for the 5-pin packages. In some cases, the tables may list a device technology or function that is not yet available. The wafer fabrication and assembly-test site is coded into the final character for both packages. Additional tracking information is coded into “dots” or marks adjacent to the device pins. For further information about a specific device, please contact your local field sales office or the TI Product Information Center.

#### PicoGate Logic

PicoGate Logic uses a three-character name rule. The first character denotes the technology family, the second character denotes device function, and the third character denotes a wafer fabrication and assembly-test facility combination (for internal tracking, here denoted by x).

**Example:** A PicoGate Logic device with a package code of BAx is an SN74AHCT1G00DBV.

#### Microgate Logic

Microgate Logic uses a four-character name rule. The first character denotes the technology family, the second and third characters denote device function, and the fourth character denotes a wafer fabrication and assembly-test facility combination (for internal tracking, here denoted by x).

**Example:** A Microgate Logic device with a package code of A02x is an SN74AHC1G02DCK.

#### NanoStar™ Package

The NanoStar package uses a three-character name rule. The first character denotes the technology family, the second character denotes device function, and the third character denotes a wafer fabrication and assembly-test facility combination (for internal tracking, here denoted by x).

Note: On NanoStar packages, the three-character device name is preceded by three additional characters denoting year (Y), month (M), and sequence code (L).

**Example:** A NanoStar package logic device with a package code of YMLCAx is an SN74LVC1G00YEA.

# LOGIC MARKING GUIDELINES

---

**Table A-3. Device Technology Codes**

TECHNOLOGY	CODE
AHC	A
AHCT	B
AUC	U
CB3T	W
CBT	S
CBTD	P
CBTLV	V
LVC	C

**Table A-4. Device Function Codes**

FUNCTION	DCK/ YEA/ YZA	DBV/ DCT/ DCU
00	A	00
02	B	02
04	C	04
05	5	05
06	T	06
07	V	07
08	E	08
125	M	25
125C		C2
126	N	26
132	Y	3B
14	F	14
157		57
17	7	17
18	J	18
240	K	40
241		41
245		45
257		B7
32	G	32
34		34
384	8	8D
53		53
57		A7
58		58
66	6	66
74		74
79	R	79
80	X	80
86	H	86
97		97
98		98
U04	D	U4

## MOISTURE SENSITIVITY BY PACKAGE

Table A-5 lists the moisture sensitivity of TI packages by level. Some packages differ in level by pin count.

**Table A-5. Package Moisture Sensitivity by Levels**

PACKAGE	LEVEL 1	LEVEL 2	LEVEL 2A	LEVEL 3	LEVEL 4
PLCC	FN (20/28)			FN (44/68)	
SOT	DBV (5) DCK (5)				
SOP		NS (14/16/20)† PS (8)†			
SOIC		D (8/14/16)† DW (16/20/24/28)†			
SSOP	DCT (8) DL (28/48/56)	DB (14/16/20/24/28/30/38)† DBQ (16/20/24)†			
QSOP		DBQ (16/20/24)†			
TSSOP	DGG (48/56/64)† PW (8/14/16/20/24)†				
TVSOP	DBB (80)† DGV (14/16/20/24/48/56)†				
VSSOP	DCU (8)				
QFN		RGY (14/16/20)†			
QFP		RC (52)			
TQFP		PAG (64) PCA (100) PN (80) PZ (100)			PM (64)
MicroStar BGA				GKE (96) GKF (114)	
MicroStar Jr. BGA			GQL (56)		
NanoStar	YEA (5/8)				

† Meets 250°C

- NOTES:
1. No current device packages are moisture-sensitivity levels 5 or 6.
  2. Some device types in these packages may have different moisture-sensitivity levels than shown.
  3. All levels except level 1 are dry packed.

TI's through-hole packages (N, NT) have not been tested per the JESD22-A112A/JESD22-A113A standards. Due to the nature of the through-hole PCB soldering process, the component package is shielded from the solder wave by the PC board and is not subjected to the higher reflow temperatures experienced by surface-mount components.

TI's through-hole component packages are classified as not moisture sensitive.

## MOISTURE SENSITIVITY BY PACKAGE

The information in Table A-6 was derived using the test procedures in JESD22-A112A and JESD22-A113A. The *Floor Life* column lists the time that products can be exposed to the open air while in inventory or on the manufacturing floor. The worst-case environmental conditions are given. The *Soak Requirements* column lists the preconditioning, or soak, conditions used when testing to determine the floor-life exposure time.

**Table A-6. Moisture-Sensitivity Levels  
(JESD22-A112A/JESD22-A113A)**

LEVEL	FLOOR LIFE		SOAK REQUIREMENTS	
	CONDITIONS	TIME (hours)	CONDITIONS	TIME (hours)
1	≤ 30°C/90% RH	Unlimited	85°C/85% RH	168
2	≤ 30°C/60% RH	1 year	85°C/60% RH	168
2A	≤ 30°C/60% RH	4 weeks	30°C/60% RH	696
				<b>X + Y = Z†</b>
3	≤ 30°C/60% RH	168	30°C/60% RH	24 + 168 = 192
4	≤ 30°C/60% RH	72	30°C/60% RH	24 + 72 = 96
5	≤ 30°C/60% RH	24	30°C/60% RH	24 + 24 = 48
6	≤ 30°C/60% RH	6	30°C/60% RH	0 + 6 = 6

RH = Relative humidity

† X + Y = Z, where:

X = Default value of time between bake and bag. If the actual time exceeds this value, use the actual time and adjust the soak time (Z). For levels 3–6, X can be standardized at 24 hours as long as the actual time does not exceed this value.

Y = Floor life of package after it is removed from dry-pack bag

Z = Total soak time for the evaluation

For more information, see:

*Packaging Material Standards for Moisture-Sensitive Items*, EIA Std EIA-583

*Symbol and Labels for Moisture-Sensitive Devices*, EIA/JEDEC Engineering Publication EIA/JEP113-B, May 1999

*Guidelines for the Packing, Handling, and Repacking of Moisture-Sensitive Components*, EIA/JEDEC Publication EIA/JEP124, December 1995

## PACKAGING CROSS-REFERENCE

Table A-7 is a packaging cross-reference for TI and other semiconductor manufacturing companies. If a specific alternate source agreement exists between TI and a particular company, the cell is shaded.

**Table A-7. Logic Package Competitive Cross-Reference**

PACKAGE TYPE	NO. PINS	PACKAGE										
		TI	TI-ACQUIRED HARRIS	TI-ACQUIRED CYPRESS	FAIRCHILD	HITACHI	IDT	IDT-ACQUIRED QUALITY	ON (formerly Motorola)	PERICOM	PHILIPS	TOSHIBA
DSBGAT†	5	YEA‡	—	—	MicroPak™	—	—	—	—	—	—	—
	8	YEA‡	—	—	MicroPak™	—	—	—	—	—	—	—
LFBGA	96	GKE‡	—	—	—	—	BF	—	—	—	GKE	—
	114	GKF‡	—	—	—	—	BF	—	—	NB	GKF	—
PDIP	14	N	E	P	N,P	DP	P	P	N	P	N	P
	16	N	E	P	P	DP	P	—	N	P	N	—
	20	N	E	P	P	DP	P	—	N	P	N	—
	24	NT	EN	P	SP	DP	PT	P	N	P	N2	—
	28	NT	—	P	—	DP	PT	—	—	P	—	—
QSOP	16	DBQ	—	—	—	—	Q	Q	—	—	—	—
	20	DBQ	—	—	—	—	Q	Q	—	Q	—	—
	24	DBQ	—	—	—	—	Q	Q	—	—	—	—
SOIC	14	D	M	S0	M,S,SC	FP	DC	S1	D	W	D	FN
	16	D	M	S0	M,S,SC	FP	DC	S1	D	W	D	FN
	16	DW	—	S0	—	—	SO	S0	DW	S	—	—
	20	DW	M	S0	WM,SC	FP	SO	S0	DW	S	DW	FW
	24	DW	M	S0	WM,SC	FP	SO	S0	DW	S	DW	—
	28	DW	—	S0	—	FP	SO	S0	—	S	DW	—
SSOP	14	DB	—	—	—	—	—	—	SD	H	DB	FS
	16	DB	SM	—	—	—	—	—	SD	H	DB	FS
	16	DBQ	—	Q	—	—	Q	Q	—	Q	—	—
	20	DB	SM	—	MSA	—	PY	—	SD	H	DB	FS
	20	DBQ	—	Q	QSC	—	Q	Q	—	Q	—	—
	24	DB	SM	Q	MSA	—	PY	—	SD	H	DB	—
	24	DBQ	—	Q	—	—	Q	Q	—	Q	—	—
	28	DB	—	—	—	—	PY	—	—	H	DB	—
	30	DB	—	—	—	—	—	—	—	—	—	—
	38	DB	—	—	—	—	—	—	—	—	—	—
	28	DL	—	—	—	—	—	—	—	—	—	—
	48	DL	—	PV	MEA/SSC	—	PV	PV	—	V	DL	—
	56	DL	—	PV	MEA/SSC	—	PV	PV	—	V	DL	—

**LEGEND:**

 TI and this company have an alternate source agreement.

MicroPak is a trademark of Fairchild Semiconductor Corporation.

## PACKAGING CROSS-REFERENCE

**Table A-7. Logic Package Competitive Cross-Reference (continued)**

PACKAGE TYPE	NO. PINS	PACKAGE										
		TI	TI-ACQUIRED HARRIS	TI-ACQUIRED CYPRESS	FAIRCHILD	HITACHI	IDT	IDT-ACQUIRED QUALITY	ON (formerly Motorola)	PERICOM	PHILIPS	TOSHIBA
TSSOP	14	PW	—	—	MTC	TTP	—	—	DT	L	PW/DH	FT
	16	PW	—	—	MTC	TTP	—	—	DT	L	PW/DH	FT
	20	PW	—	—	MTC	TTP	PG	—	DT	L	PW/DH	FT
	24	PW	—	—	MTC	TTP	PG	PA	DT	L	PW/DH	—
	28	PW	—	—	—	TTP	PG	—	—	L	—	—
	48	DGG	—	PA	MTD	TTP	PA	PA	DT	A	DGG	FT
	56	DGG	—	PA	MTD	TTP	PA	PA	DT	A	DGG	FT
	64	DGG	—	—	—	TTP	—	—	—	—	—	—
TVSOP	14	DGV	—	—	—	—	—	—	—	—	DGV	—
	16	DGV	—	—	—	—	—	—	—	—	—	—
	20	DGV	—	—	—	—	—	—	—	—	—	—
	24	DGV	—	—	—	—	—	—	—	—	—	—
	48	DGV	—	—	—	—	PF	Q1§	—	K¶	—	—
	56	DGV	—	—	—	—	PF	—	—	K¶	—	—
	80	DBB	—	—	—	TTP	—	—	—	—	—	—
VFBGA	20	GQN‡	—	—	—	—	—	—	—	—	—	—
	56	GQL‡	—	—	—	—	—	—	—	—	—	—
Single Gate	5	DBV	—	—	P5	MPAK	—	—	—	—	—	F
	5	DCK	—	—	M5	CMPAK	—	—	DF	—	DCK	FU
Dual Gate	8	DCT	—	—	—	SSOP-8	—	—	—	—	—	FU
	8	DCU	—	—	—	—	—	—	—	—	—	FK
Tape and Reel#		R  *	96	T	X	R	T/R	X	T1, T3, T4, R1, R2, RL	X	-T	EL

† DSBGA is the JEDEC reference for wafer chip scale package (WCSP).

‡ Also available in lead free

§ Quality Semiconductor's QVSOP package has the same pitch but slightly different footprint than TI's TVSOP package.

¶ Pericom has a QVSOP with similar specifications and lead pitch to TI's TVSOP package.

# Tape-and-reel packaging is valid for surface-mount packages only. All orders must be for whole reels.

|| LE = Left-embossed tape and reel may be seen with some DB and PW packages, however, the nomenclature is transitioning to R.

\* R = Standard tape and reel (required for DBB, DBV, and DGG; optional for D, DL, and DW packages)

**LEGEND:**

TI and this company have an alternate source agreement.



## PACKAGING CROSS-REFERENCE

### Logic Devices

Tables A-8 through A-11 list the standard pack quantities, by package type, for tubes, reels, boxes, and trays, respectively.

**Table A-8. Tube Quantities**

	PIN COUNT									
	8	14	16	20	24	28	44	48	56	68
DIP	50	25	25	20	15	13	N/A	N/A	N/A	N/A
PLCC	N/A	N/A	N/A	46	N/A	37	26	N/A	N/A	18
SOIC	75	50	40	25	25	20	N/A	N/A	N/A	N/A
SSOP	N/A	N/A	NS	N/A	N/A	40	N/A	25	20	N/A

NOTE 1: QSOP (DBQ) and EIAJ devices (DB, NS, PS, and PW packages) are not available in tubes.

**Table A-9. Reel Quantities**

		PACKAGE DESIGNATOR	UNITS PER REEL
DSBGA†	96/114 pin	YEAR‡	3000
EIAJ surface mount		DBR/DBLE, NSR/NSLE, PWR/PWLE	2000
LFBGA	96/114 pin	GKE‡, GKF‡	1000
PLCC	20 pin	FNR	1000
	28 pin	FNR	750
	44 pin	FNR	500
QFN	14/16/20 pin	RGY	1000
	56 pin	RGQ	2000
QSOP	16/20/24 pin	DBQR	2500
SSOP	48/56 pin	DLR	1000
SOIC/SOP	14/16 pin	DR	2500
	Widebody 16 pin	DWR	2000
	20/24 pin	DWR	2000
	28 pin	DWR	1000
TQFP	64 pin	PMR	1000
TSSOP		DGGR	2000
VFBGA	20/56 pin	GQN‡, GQL‡	1000

† DSBGA is the JEDEC reference for wafer chip scale package (WCSP).

‡ Also available in lead free

## PACKAGING CROSS-REFERENCE

---

**Table A-10. Box Quantities**

		PACKAGE DESIGNATOR	UNITS PER BOX
DIP		N	1000
		NT	750
		NP	700
SOIC		D, DW	1000
SSOP	48/56 pin	DL	1000

**Table A-11. Tray Quantities**

		PACKAGE DESIGNATOR	UNITS PER TRAY
TQFP	64 pin	PM	160

<b>LOGIC OVERVIEW</b>	<b>1</b>
<b>FOCUS ON NAVIGATING THE TI LOGIC WEB</b>	<b>2</b>
<b>FUNCTIONAL INDEX</b>	<b>3</b>
<b>FUNCTIONAL CROSS-REFERENCE</b>	<b>4</b>
<b>DEVICE SELECTION GUIDE</b>	<b>5</b>
<b>PACKAGING AND MARKING INFORMATION</b>	<b>A</b>
<b>LOGIC PURCHASING TOOL/ALTERNATE SOURCES</b>	<b>B</b>

**LOGIC PURCHASING TOOL/ALTERNATE SOURCES**



## LOGIC PURCHASING TOOL/ALTERNATE SOURCES

Tables B-1 through B-4 list equivalent or similar product types for most logic families available in the industry, separated by voltage node and specialty logic. As the world leader in logic products, TI offers the broadest logic portfolio to meet your design needs.

Alternate sourcing agreements between TI and other companies are shown with shaded table cells. Crosshatched cells are used where the products are identical (or nearly identical). Cells with no background are used where the products are similar.

**Table B-1. 5-V Logic**

TI	FAIRCHILD	HITACHI	IDT	ON	PERICOM	PHILIPS	TOSHIBA
ABT	ABT	ABT				ABT	ABT
AC	AC	AC		AC			AC
ACT	ACT	ACT		ACT			ACT
AHC	VHC			VHC		AHC	
AHCT	VHCT			VHCT		AHCT	
AHC1G	NC7S					HC1G	7SHU
AHCT1G							
ALS	ALS					ALS	
AS	AS						
BCT	BCT			BC			BC
CBT/BUS	FST		FST, QS		PI5C		
CD4000	CD4000			MC14000			
F	F			F		F	
FCT			FCT		FCT		
HC	HC	HC		HC		HC	HC
HCT	HCT	HCT		HCT		HCT	HCT
LS	LS			LS			
S	S						
TTL	TTL						

**LEGEND:**

TI and this company have an alternate source agreement.

Same product but no alternate source agreement

NAME Similar product and technology

Cypress = Cypress Semiconductor, Fairchild = Fairchild Semiconductor, Hitachi = Hitachi Semiconductor (America), Inc., IDT = Integrated Device Technology, Inc., ON = ON Semiconductor, Pericom = Pericom Semiconductor Corporation, Philips = Philips Semiconductors, Toshiba = Toshiba America Electronic Components, Inc.

## LOGIC PURCHASING TOOL/ALTERNATE SOURCES

**Table B-2. 3.3-V Logic**

TI	FAIRCHILD	HITACHI	IDT	ON	PERICOM	PHILIPS	TOSHIBA
ALB							
ALVC	VCX	ALVC	ALVC	VCX	ALVC	ALVC	VCX
CBTLV			QS3VH		P13B		
LV	LVQ/LVX	LV		LVQ/LVX		LV	LVQ/LVX
LVC	LCX	LVC	LVC/LCX	LCX	LCX/LPT	LVC	LCX
LVT	LVT	LVT				LVT	

LEGEND:

 TI and this company have an alternate source agreement.

 Same product but no alternate source agreement

 NAME Similar product and technology

**Table B-3. 2.5-V Logic**

TI	PERICOM	PHILIPS
ALVT	ALVT	ALVT
AVC	AVC	AVC

LEGEND:

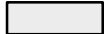
 TI and this company have an alternate source agreement.

 Same product but no alternate source agreement

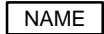
 NAME Similar product and technology

**Table B-4. 1.8-V Logic**

TI	HITACHI	IDT	PHILIPS
AUC			

LEGEND:

 TI and this company have an alternate source agreement.

 Same product but no alternate source agreement

 NAME Similar product and technology

## LOGIC PURCHASING TOOL/ALTERNATE SOURCES

**Table B-5. Specialty Logic**

TI	FAIRCHILD	HITACHI	IDT	PERICOM	PHILIPS
ABTE	ETL/VME				
FB	DS				FB
GTL					GTL
GTLP	GTLP			GTLP	
HSTL					
JTAG	SCAN		QS3J		
TVC					GTL
PCA					PCA
SSTL		SSTL			
SSTV	SSTV	SSTV	SSTV	SSTV	SSTV
SSTVF			SSTVF	SSTVF	

LEGEND:

TI and this company have an alternate source agreement.

Same product but no alternate source agreement

NAME Similar product and technology